

Powered by



# TPL 121350A ▶12V 135Ah

TPL 121350A is a front terminal battery up to 12 years expected life under normal float charge As with all CSB batteries, all are rechargeable, highly efficient, leak proof and maintenance free.



## ► Specification

Cells Per Unit	6
Voltage Per Unit	12
Capacity	135Ah @ 8hr-rate to 1.75V per cell @25 °C(77°F)
Weight	Approx. 53.6kg(118.17 lbs)
Maximum Discharge Current	800A(5sec)
Internal Resistance	Approx. 6.5 m Ω
Operating Temperature Range	Discharge: -15°C~50°C ( 5 °F~122°F) Charge: -15°C~40°C ( 5 °F~104°F) Storage: -15°C~40°C ( 5 °F~104°F)
Nominal Operating Temperature Range	25°C±3°C(77°F±5°F)
Float Charging Voltage	2.275 ± 0.025V / Cell at 25 °C (77°F) Temp. Coefficient ±3.3mV/°C(± 1.8mV/°F)
Recommended Maximum Charging Current Limit	40.5A
Equalization / Cycle Use Charging Voltage	2.45V Temps coefficient ±5mV/°C
Terminal	I2-Thread lead alloy recessed terminal to accept M6 bolt
Terminal Hardware Initial Torque	120-in-lbs.(13.58 N-m)
Container Material	ABS(UL94-V0) & (UL94-HB) / L.O.I higher than 28



CSB-manufactured **VRLA** (Absorbent **G**lass **M**at type) batteries are UL-recognized components under UL1989.

CSB is also certified by ISO 9001 and ISO 14001.

## ► Dimensions :

Overall Height (H)	Length (L)	Width (W)
Unit: mm (inch)		
323.0±2.5 (12.72±0.10)	547.0±2.5(21.54±0.10)	125.6±1.5 (4.94±0.06)

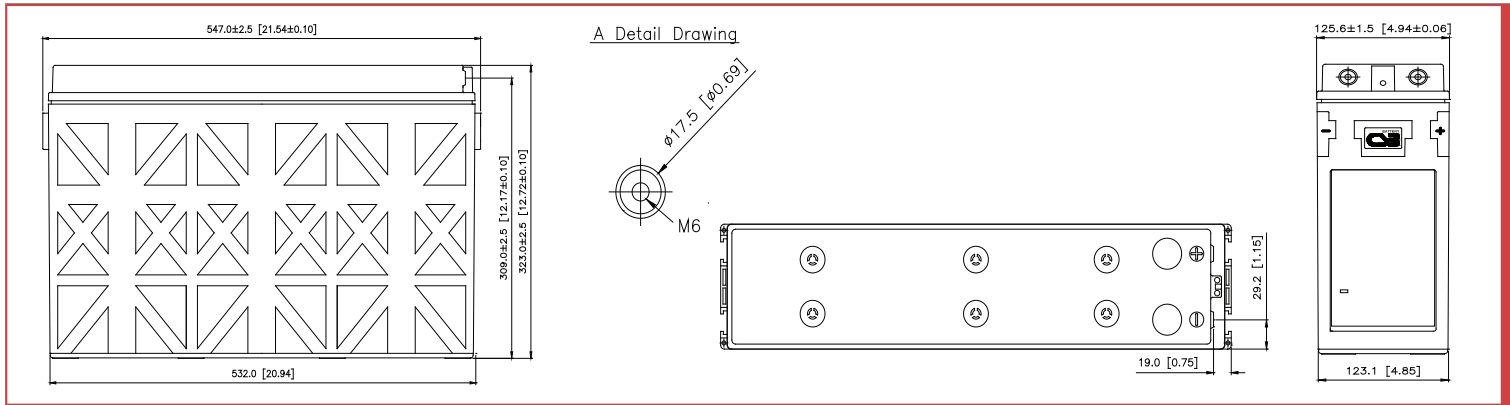

## Constant Current Discharge Characteristics Unit:A (25°C, 77°F)

F.V/Time	15MIN	30MIN	60MIN	90MIN	2HR	3HR	4HR	5HR	6HR	7HR	8HR	10HR	20HR
1.67V	250	159	93.2	68.1	54.2	39.9	32.1	26.7	22.8	19.8	17.6	14.3	7.51
1.70V	236	153	91.0	66.7	53.6	39.5	31.7	26.3	22.4	19.6	17.2	14.2	7.43
1.75V	213	144	87.2	64.7	52.7	38.4	30.8	25.3	21.6	18.9	16.9	13.8	7.26
1.80V	189	132	82.3	62.2	51.3	37.2	29.4	24.5	21.1	18.3	16.3	13.5	7.09
1.83V	174	125	79.1	60.7	49.9	35.9	28.5	23.8	20.5	17.8	15.8	13.0	6.92
1.85V	164	119	76.4	59.2	48.7	35.0	27.9	23.2	20.0	17.5	15.5	12.8	6.75
1.90V	142	106	69.4	56.4	43.3	31.9	25.3	21.1	18.0	15.9	14.2	11.7	6.24

## Constant Power Discharge Characteristics Unit:W (25°C, 77°F)

F.V/Time	15MIN	30MIN	60MIN	90MIN	2HR	3HR	4HR	5HR	6HR	7HR	8HR	10HR	20HR
1.67V	2,658	1,718	1,022	751	602	447	362	301	257	224	198	162	85.2
1.70V	2,544	1,672	996	739	601	446	360	299	256	223	196	161	84.9
1.75V	2,339	1,586	958	716	587	440	354	292	249	218	195	160	84.1
1.80V	2,095	1,488	927	699	574	432	342	286	247	214	191	157	83.2
1.83V	1,954	1,387	893	684	561	420	335	280	242	210	186	153	81.8
1.85V	1,857	1,343	871	668	545	410	330	275	237	207	184	152	80.3
1.90V	1,631	1,233	818	628	515	381	303	253	216	190	170	141	75.2

Ratings presented herein are subject to revision without notice. Please refer to [www.csb-battery.com](http://www.csb-battery.com) to confirm the latest version.

### Trickle (or Float) Service Life

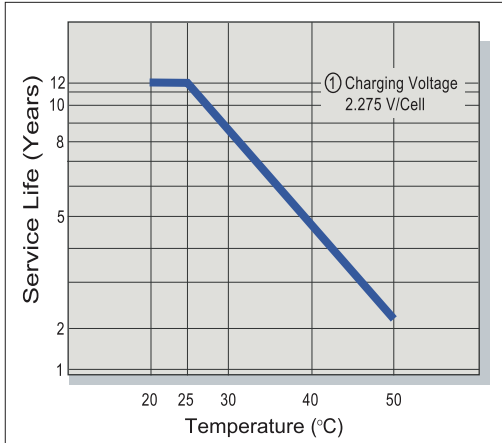

### Capacity Retention Characteristic

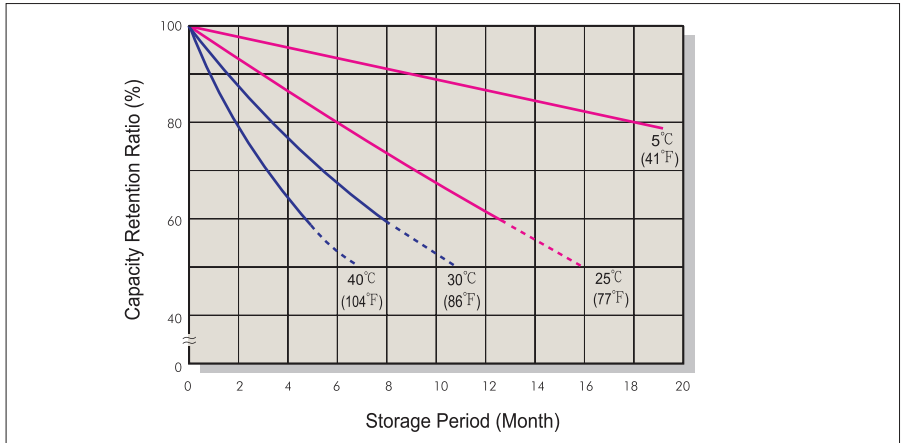

### Battery Voltage and Charge Time for Standby Use

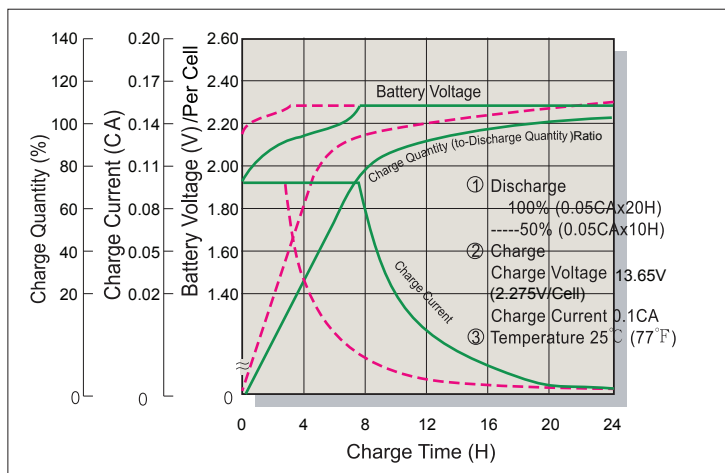

### Cycle Service Life

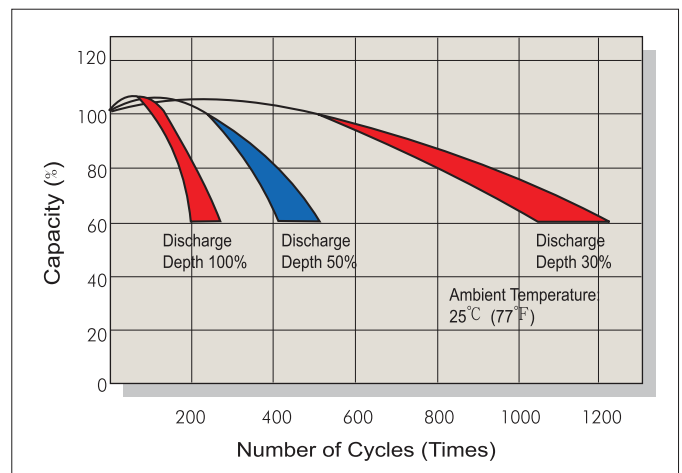

### Battery Voltage and Charge Time for Cycle Use

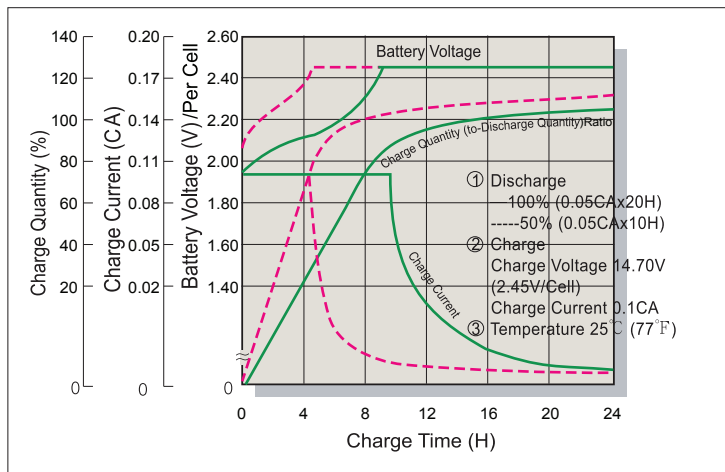

### Terminal Voltage (V) and Discharge Time

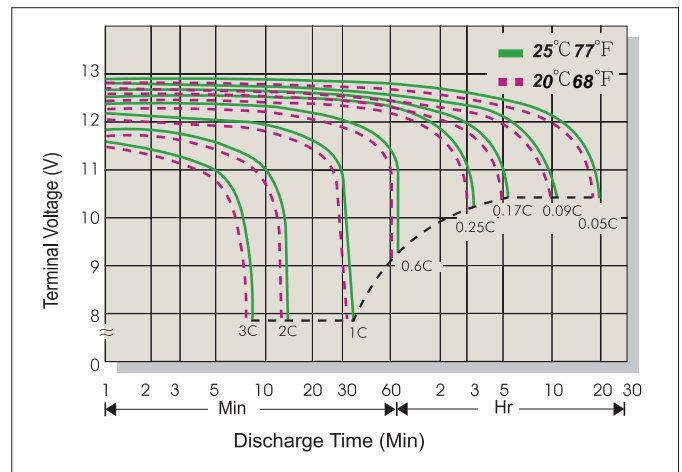

### Charging Procedures

Application	Charge Voltage(V/Cell)			Max. Charge Current
	Temperature	Set Point	Allowable Range	
Cycle Use	25°C(77°F)	2.45	2.40~2.50	0.3C
Standby	25°C(77°F)	2.275	2.25~2.30	

### Discharge Current VS. Discharge Voltage

Final Discharge Voltage V/Cell	1.75	1.70	1.60	1.30
Discharge Current(A)	0.2C>(A)	0.2C<(A)<0.5C	0.5C<(A)<1.0C	(A)>1.0C

Sales Office URL: [WWW.CSB-BATTERY.COM](http://WWW.CSB-BATTERY.COM)

**GLOBAL HQ**  
**CSB BATTERY CO., LTD. (TAIWAN)**  
 Tel : +886-2-2880-5600  
 Fax : +886-2-2888-3300  
 mail : service@csb-battery.com.tw

**BEIJING OFFICE. (CHINA)**  
**CSB BATTERY TECHNOLOGIES (BEIJING) CO., LTD.**  
 Tel : +86-10-5820-5336/5338  
 Fax : +86-10-58203053  
 mail : chinasl@csb-battery.com

**AMERICA HQ**  
**CSB BATTERY TECHNOLOGIES INC. (U.S.A)**  
 Tel : +1-817-244-7777/1-(800)3-CSB-USA(272872)  
 Fax : +1-817-244-4445  
 mail : csb@csb-battery.com

**SHANGHAI OFFICE. (CHINA)**  
**CSB BATTERY LOGISTIC (SHANGHAI) CO., LTD.**  
 Tel : +86-21-5046-1622/5046-0833  
 Fax : +86-21-5064-1046  
 mail : chinasl@csb-battery.com

**EUROPE HQ**  
**CSB Battery Europe BV.**  
 Tel : +31(0)-180-418-140  
 Fax : +31(0)-180-418-327  
 mail : eurosales@csb-battery.eu

**SHENZHEN OFFICE. (CHINA)**  
**CSB BATTERY LOGISTIC (SHANGHAI) CO., LTD.**  
 Tel : +86-755-8831-6488/6396/6356  
 Fax : +86-755-8831-6548  
 mail : she@csb-battery.com.cn