

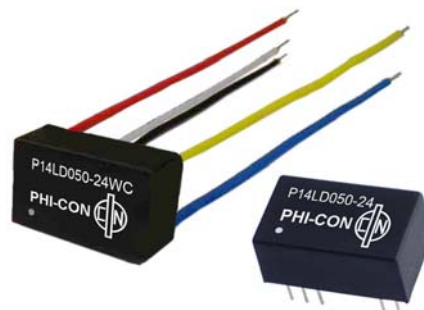

PHI-CON

P14LD050-24 Step Down Driver for 0.5 A Power-LED

- Constant Current Output
- Dimmer function via analogue Control
- Dimmer function via PWM Control
- Remote control function
- 16 Pin DIL Package
- Efficiency up to 95 %
- MTBF > 4.7 MHours



P14LD050-24 is a high efficiency step-down converter optimized to drive high current LEDs. The control algorithm allows highly efficient and precise LED current regulation. This driver operates in an dc supply voltage range between 7 V and 30 V and provides an externally adjustable output current of up to 0.5 A and output power up to 14 watts. A compact size allows designer to integrate this driver together with LED module.

Specification at 25 °C, Vin nominal and rated output current

Input	
Input voltage range	7...30 V
Input filter	Capacitor
Output	
Output voltage range at Vin 30 V	2...28 V
Output current range at Vin - Vout > 1.5 V to 3 V	500 mA
Output power	14 W, max.
Typical output current accuracy, at Iout 1000 mA	±6 %
Output ripple and noise, bandwidth 20 MHz	250 mVp-p, max.
Temperature coefficient at Ta -40 to +85 °C	±0.05 % / °C, max.
Capacitive load	47 µF, max.
Operating frequency range	70 kHz...330 kHz
Efficiency, maximum at full load	95 %
Short circuit protection	Regulated at rated output current
PWM dimming & remote control	
Vdim input, remote ON level	Open or 0.3 V ... 1.25 V
Vdim input, remote OFF level (shutdown)	0.15 V max.
Vdim input, drive current (Vdim 1.25V)	1 mA, max.
Quiescent supply current in shutdown mode at Vin 30V	25 µA, max.
Recommended maximum operation frequency	1 kHz
Minimum switch 'ON' time	200 ns
Minimum switch 'OFF' time	200 ns
Analog dimming control	
Vdim input control voltage range for 25 ... 100 % output current range	0.3 V ... 1.25 V
Vdim input control voltage range ON	0.2 V ... 0.3 V
Vdim input control voltage range OFF	0.15 V ... 0.25 V
Vdim input, drive current (Vdim 1.25V)	1 mA, max.
Physical conditions	
Operating ambient temperature range	-40 to +85 °C
Storage temperature range	-40 to +125 °C
Operating Package temperature	100 °C, max.
Thermal impedance, nature convection	40 K/W
Humidity	95 % rel H
Reliability calculated MTBF (MIL-HDBK-217 F)	>4.7 Mhrs
Case material	Non-conductive black plastic (UL94-V0)
Potting material	Epoxy (UL94-V0)
Pin material	0.5 mm brass solder-coated
Weight	6.2 g PCB version, 11 g wire version
Dimensions	23.4 x 14 x 10.2 mm
Soldering temperature 1.5 mm distance from body	260 °C for 10 sec
EMC Specifications in accordance with	
EMI radiated and conducted emissions EN55015 (CISPR22)	
EMS Immunity EN61547	
IEC 61000-4-2	Perf. Criteria A
IEC 61000-4-3	Perf. Criteria A
IEC 61000-4-4	Perf. Criteria A
IEC 61000-4-6	Perf. Criteria A
IEC 61000-4-8	Perf. Criteria A

P14LD050-24 Step Down Driver for 0.5 A Power-LED

Typical application circuits

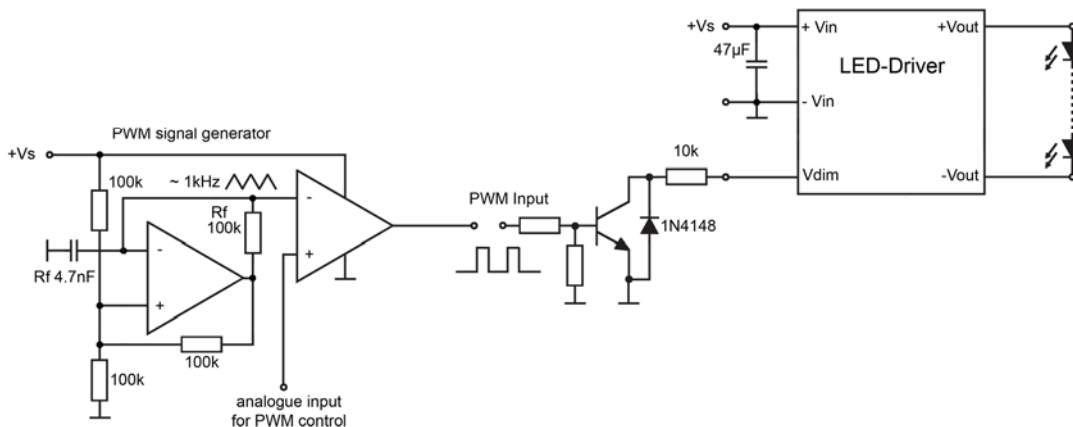
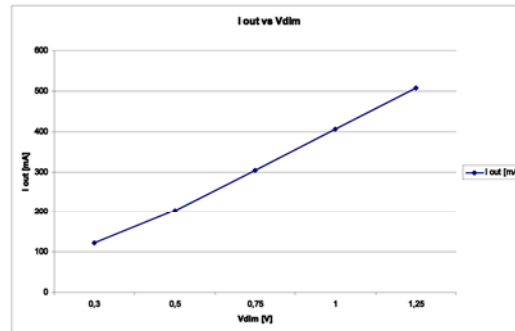
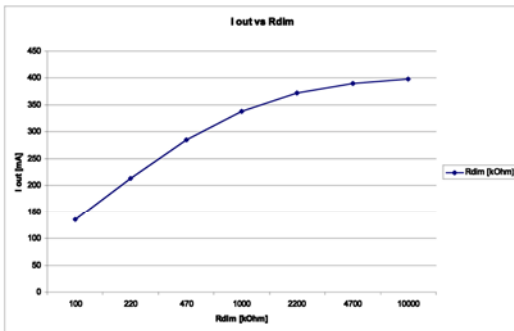
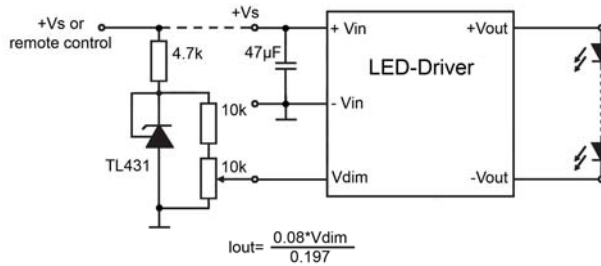
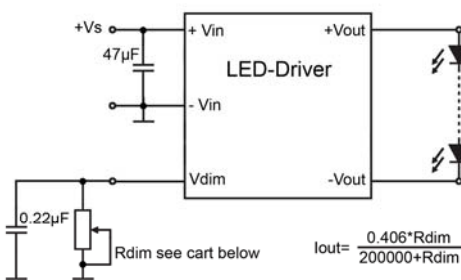
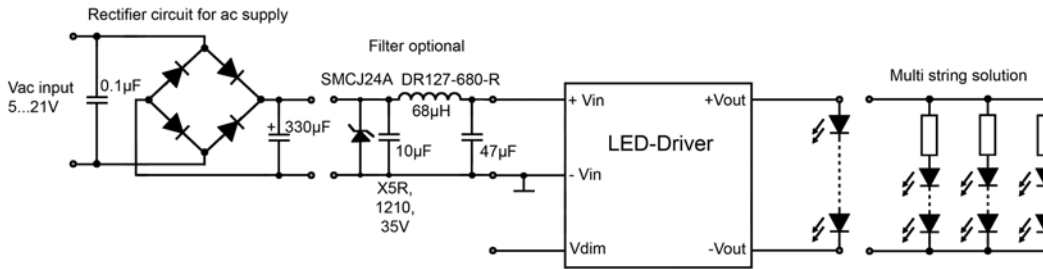

Notes:

1. Do not use the driver over 14 W output power!
2. Do not connect a reversed power source!
3. Do not connect the input side with output side!

P14LD050-24 Step Down Driver for 0.5 A Power-LED

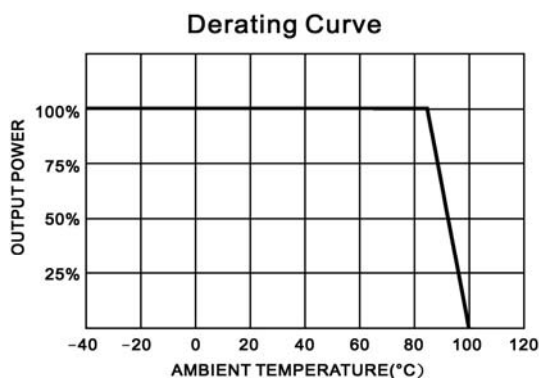
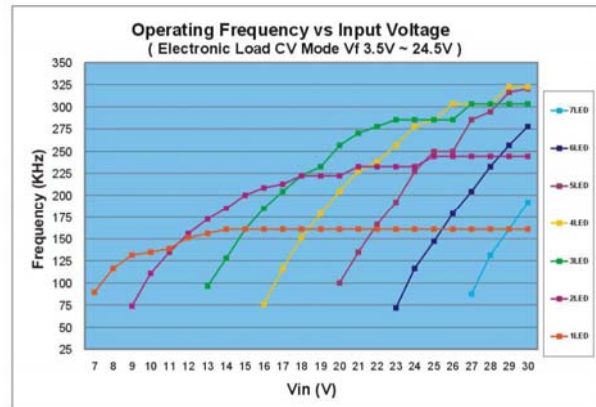
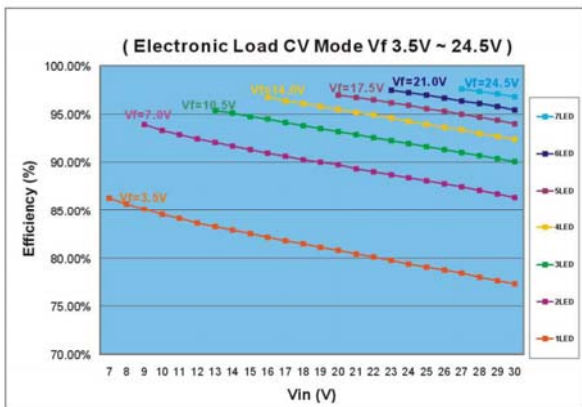

Pin connections

Pin	Function
1, 2	- V supply
3	Vdim
7, 8	- V output
9, 10	+ V output
15, 16	+ V supply

Pin	Wire-Color	Function
1	black	- V supply
2	white	Vdim
8	blue	- V output
9	yellow	+ V output
16	red	+ V supply

Dimensions

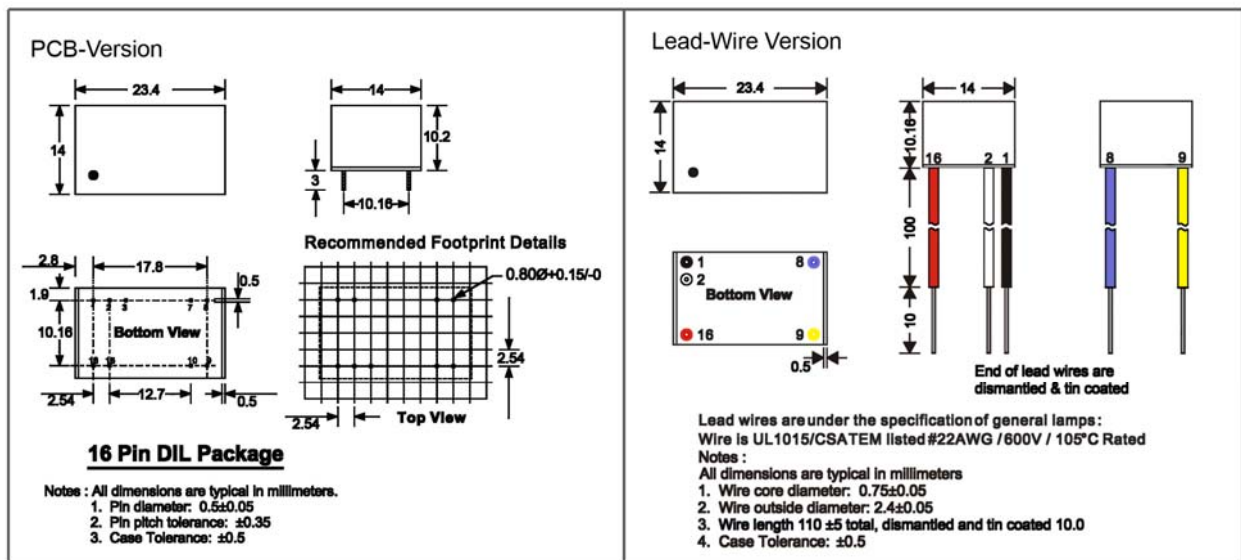

Only for professional use by professionals! Not for resale or distribution to the general public in any way! Read the instructions for use carefully before using!

Life Support Policy: HY-LINE does not authorize the use of any of its products for use in life support devices or systems without the express written approval of an officer of the Company. Life support systems are devices which support or sustain life, and whose failure to perform, when properly used in accordance with instructions for use provided in the labeling, can be reasonably expected to result in significant injury to the user. Rev: 7.12 f