

Powered by



HRL 12500W ▶ 12V 500W

HRL 12500W is specially designed for high efficient discharge application. Its characteristics are high energy density, small footprint and high discharge efficiency. It can be used for more than 260 cycles at 100% discharge in cycle service, up to 10 years in standby service.



Specification

Cells per unit	6
Voltage per unit	12
Capacity	500W @ 15min-rate to 1.67V per cell @25 °C(77°F)
Weight	Approx.45.7 kg(100.75 lbs)
Maximum Discharge Current	800A(5sec)
Internal Resistance	Approx.3.7 mΩ
Operating Temperature Range	Discharge: -15°C~50°C (5°F~122°F) Charge: -15 °C~40°C (5°F~104°F) Storage: -15°C~40°C (5°F~104°F)
Nominal Operating Temperature Range	25°C±3°C (77°F±5°F)
Float Charging Voltage	13.5 to 13.8 VDC/unit Average at 25°C (77°F)
Recommended Maximum Charging Current Limit	50A
Equalization and Cycle Service	14.4 to 15.0 VDC/unit Average at 25°C (77°F)
Self Discharge	CSB Batteries can be stored for more than 6 months at 25°C (77°F). Please charge batteries before using. For higher temperatures the time interval will be shorter.
Terminal	I2-Thread lead alloy recessed terminal to accept M6/M8 bolt
Container Material	PPE(UL94-V0)*Flammability resistance can be available upon request.



CSB-manufactured **VRLA** (Absorbent Glass Mat type) batteries are UL-recognized components under UL1989.

CSB is also certified by ISO 9001 and ISO 14001.

Dimensions :	Overall Height (H)	Container height (h)	Length (L)	Width (W)
Unit: mm (inch)	277.7±2.5(10.93±0.10)	274.7±2.5 (10.81±0.10)	343.0±2.5 (13.50±0.10)	170.0±2.0 (6.69±0.08)

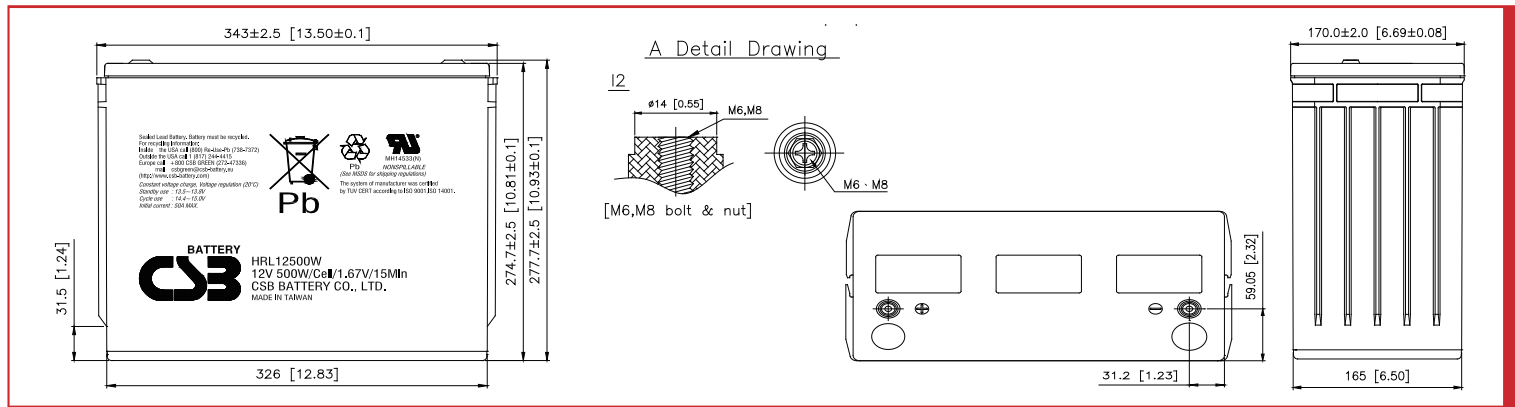

Constant Current Discharge Characteristics Unit:A (25°C ,77°F)

F.V/Time	5MIN	7.5MIN	10MIN	15MIN	20MIN	30MIN	40MIN	50MIN	60MIN	90MIN
1.60V	491	444	388	294	235	172	136	112	95.7	67.2
1.67V	449	405	356	278	223	164	134	110	94.3	66.1
1.70V	425	386	340	270	217	161	133	109	93.5	65.4
1.75V	388	348	310	253	206	155	130	107	91.1	64.5
1.80V	348	309	278	233	194	147	123	102	87.3	62.0
1.85V	304	270	247	211	179	140	115	95.3	81.1	57.3

Constant Power Discharge Characteristics Unit:W (25°C ,77°F)

F.V/Time	5MIN	7.5MIN	10MIN	15MIN	20MIN	30MIN	40MIN	50MIN	60MIN	90MIN
1.60V	5,275	4,691	4,167	3,181	2,594	1,951	1,558	1,292	1,112	783
1.67V	4,880	4,300	3,790	3,018	2,490	1,871	1,520	1,276	1,091	769
1.70V	4,640	4,110	3,610	2,932	2,422	1,829	1,507	1,258	1,083	763
1.75V	4,250	3,750	3,290	2,748	2,309	1,740	1,466	1,237	1,066	754
1.80V	3,830	3,340	2,950	2,497	2,138	1,657	1,390	1,186	1,025	731
1.85V	3,366	2,882	2,600	2,203	1,964	1,564	1,321	1,130	977	695

Ratings presented herein are subject to revision without notice. Please refer to www.csb-battery.com to confirm the latest version.

Trickle (or Float) Service Life

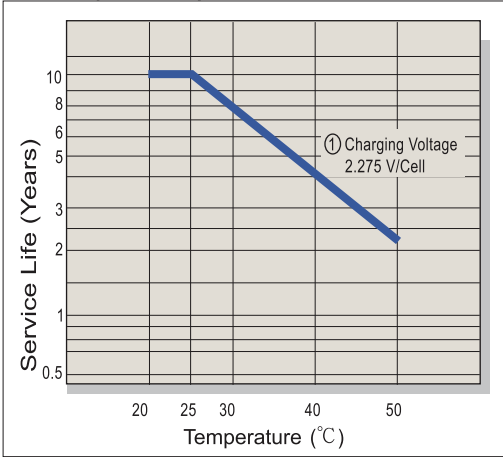

Capacity Retention Characteristic

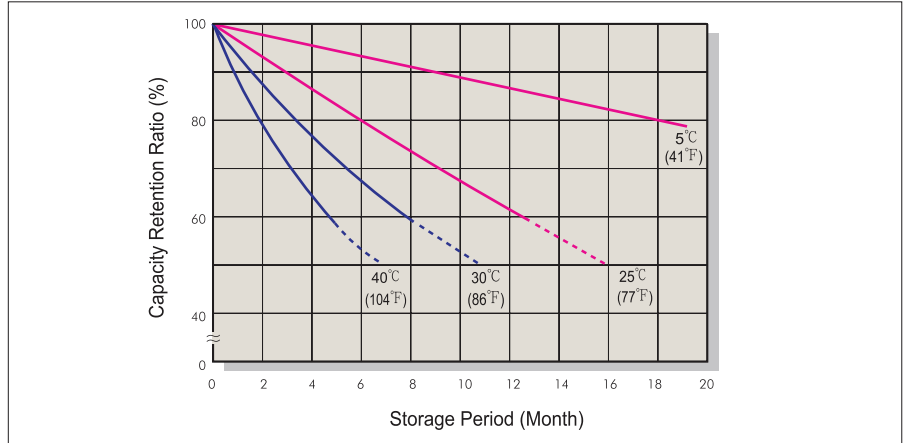

Battery Voltage and Charge Time for Standby Use

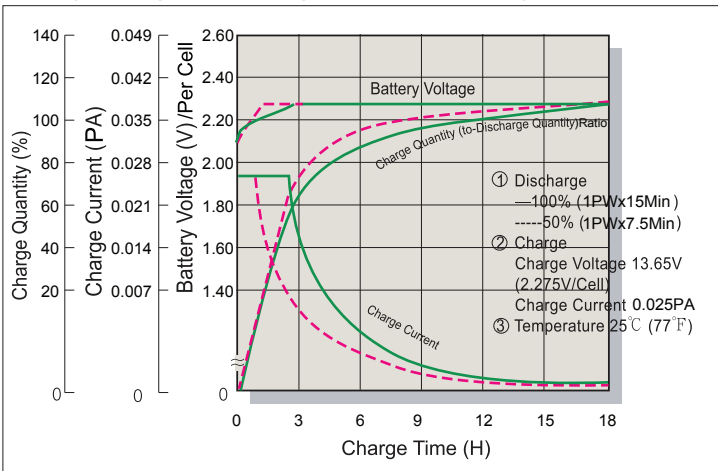

Cycle Service Life

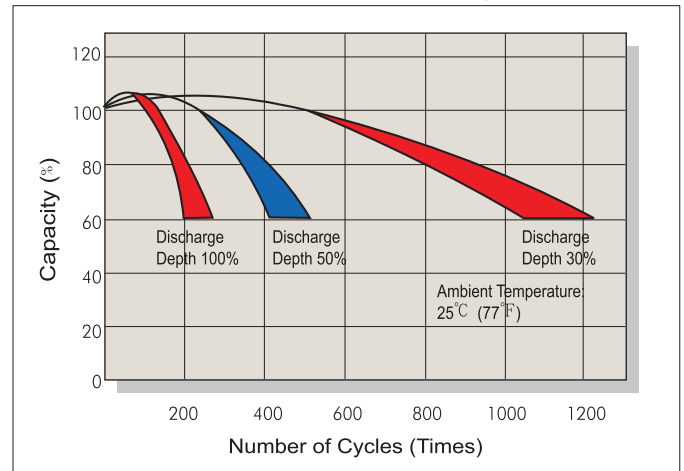

Battery Voltage and Charge Time for Cycle Use

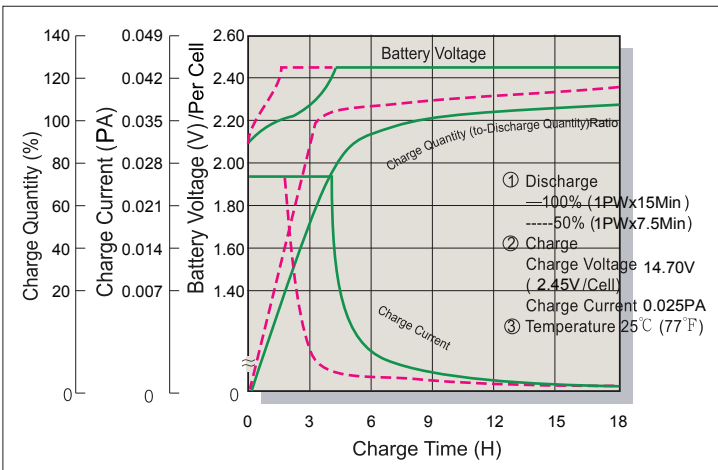

Terminal Voltage (V) and Discharge Time

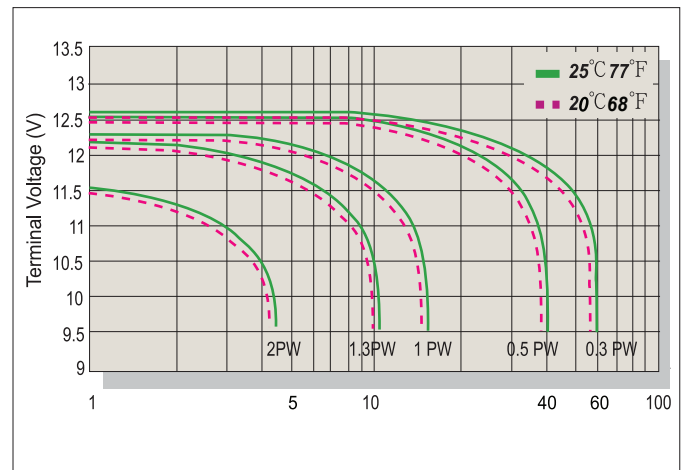

Charging Procedures

Application	Charge Voltage(V/Cell)			Max.Charge Current
	Temperature	Set Point	Allowable Range	
Cycle Use	25°C(77°F)	2.45	2.40~2.50	0.1PA
Standby	25°C(77°F)	2.275	2.25~2.30	

Discharge Current VS. Discharge Voltage

Final Discharge Voltage V/Cell	1.75	1.70	1.60	1.30
Discharge Power(W)	0.1P>(W)	0.1P≤(W)<0.25P	0.25P≤(W)<1.0P	(W)≥1.0P

Sales Office URL: WWW.CSB-BATTERY.COM

GLOBAL HQ
CSB BATTERY CO., LTD. (TAIWAN)
 Tel : +886-2-2880-5600
 Fax : +886-2-2888-3300
 mail : service@csb-battery.com.tw

BEIJING OFFICE. (CHINA)
CSB BATTERY TECHNOLOGIES (BEIJING) CO., LTD.
 Tel : +86-10-5820-5336/5338
 Fax : +86-10-58203053
 mail : chinasls@csb-battery.com

AMERICA HQ
CSB BATTERY TECHNOLOGIES INC. (U.S.A)
 Tel : +1-817-244-7777/1-(800)3-CSB-USA(272872)
 Fax : +1-817-244-4445
 mail : csb@csb-battery.com

SHANGHAI OFFICE. (CHINA)
CSB BATTERY LOGISTIC (SHANGHAI) CO., LTD.
 Tel : +86-21-5046-1622/5046-0833
 Fax : +86-21-5064-1046
 mail : chinasls@csb-battery.com

EUROPE HQ
CSB Battery Europe BV.
 Tel : +31(0)-180-418-140
 Fax : +31(0)-180-418-327
 mail : eurosales@csb-battery.eu

SHENZHEN OFFICE. (CHINA)
CSB BATTERY LOGISTIC (SHANGHAI) CO., LTD.
 Tel : +86-755-8831-6488/6396/6356
 Fax : +86-755-8831-6548
 mail : she@csb-battery.com.cn