

Powered by



HRL 1223W ▶ 12V 23W

HRL 1223W is specially designed for high efficient discharge application. Its characteristics are high energy density, small footprint and high discharge efficiency. It can be used for more than 260 cycles at 100% discharge in cycle service, up to 8 years in standby service.



Specification

Cells per unit	6
Voltage per unit	12
Capacity	23W @ 15min-rate to 1.67V per cell @25 °C(77°F)
Weight	Approx.2.1 kg(4.63 lbs)
Maximum Discharge Current	130A(5sec)
Internal Resistance	Approx. 19mΩ
Operating Temperature Range	Discharge: -15°C~50°C (5°F~122°F) Charge: -15 °C~40°C (5°F~104°F) Storage: -15°C~40°C (5°F~104°F)
Nominal Operating Temperature Range	25°C±3°C (77°F±5°F)
Float Charging Voltage	13.5 to 13.8 VDC/unit Average at 25°C (77°F)
Recommended Maximum Charging Current Limit	2.3A
Equalization and Cycle Service	14.4 to 15.0 VDC/unit Average at 25°C (77°F)
Self Discharge	CSB Batteries can be stored for more than 6 months at 25°C (77°F). Please charge batteries before using. For higher temperatures the time interval will be shorter.
Terminal	F2-Faston Tab 250
Container Material	ABS(UL 94-HB) & Flammability resistance of (UL 94-V0) can be available upon request.



CSB-manufactured **VRLA** (Absorbent Glass Mat type) batteries are UL-recognized components under UL1989.

CSB is also certified by ISO 9001 and ISO 14001.

Dimensions :	Overall Height (H)	Container height (h)	Length (L)	Width (W)
Unit: mm (inch)	106.0±1.5 (4.17±0.06)	101.8±1.5 (4.01±0.06)	90.0±1.0 (3.54±0.04)	70.0±1.0 (2.76±0.04)

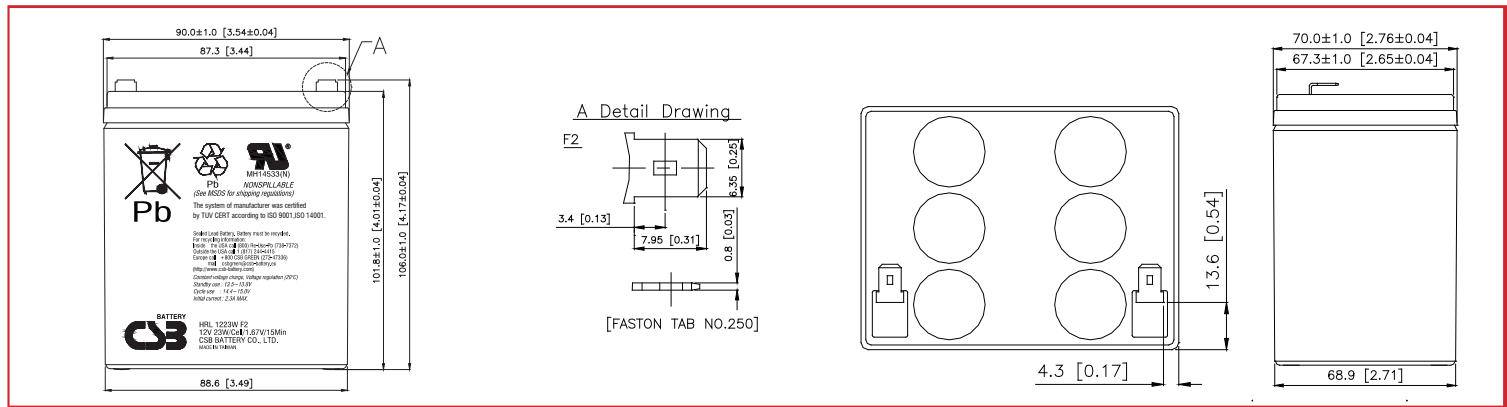

Constant Current Discharge Characteristics Unit:A (25°C ,77°F)

F.V/Time	2MIN	4MIN	6MIN	8MIN	10MIN	15MIN	20MIN	30MIN	60MIN	90MIN
1.60V	50.7	32.9	25.0	20.3	17.5	12.9	10.3	7.42	4.22	3.01
1.67V	46.7	31.4	24.2	20.0	17.3	12.8	10.2	7.35	4.18	2.99
1.70V	43.8	30.6	23.8	19.7	17.0	12.6	10.1	7.29	4.17	2.98
1.75V	39.7	28.4	22.6	19.1	16.5	12.3	10.0	7.22	4.14	2.94
1.80V	35.2	26.0	21.2	17.9	15.7	11.8	9.61	7.04	4.05	2.92
1.85V	30.6	22.8	19.1	16.2	14.3	11.0	8.99	6.58	3.85	2.78

Constant Power Discharge Characteristics Unit:W (25°C ,77°F)

F.V/Time	2MIN	4MIN	6MIN	8MIN	10MIN	15MIN	20MIN	30MIN	60MIN	90MIN
1.60V	497	337	264	221	192	141	114	84.4	49.8	36.5
1.67V	464	326	259	219	190	140	113	84.0	49.5	36.2
1.70V	445	317	258	217	188	139	112	83.6	49.2	36.0
1.75V	410	301	247	209	182	137	111	82.8	49.0	35.9
1.80V	373	278	233	199	175	133	109	80.8	48.1	35.3
1.85V	323	252	212	183	162	124	102	76.6	46.4	34.3

Ratings presented herein are subject to revision without notice. Please refer to www.csb-battery.com to confirm the latest version.

Trickle (or Float) Service Life

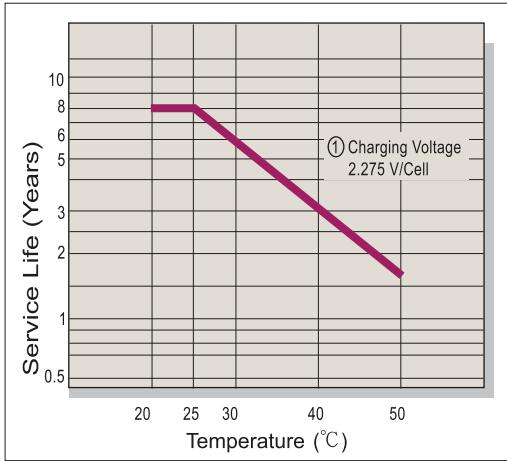

Capacity Retention Characteristic

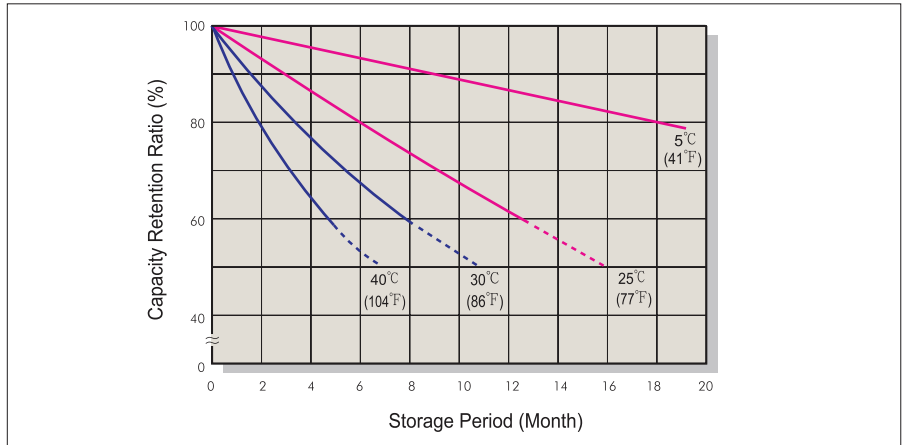

Battery Voltage and Charge Time for Standby Use

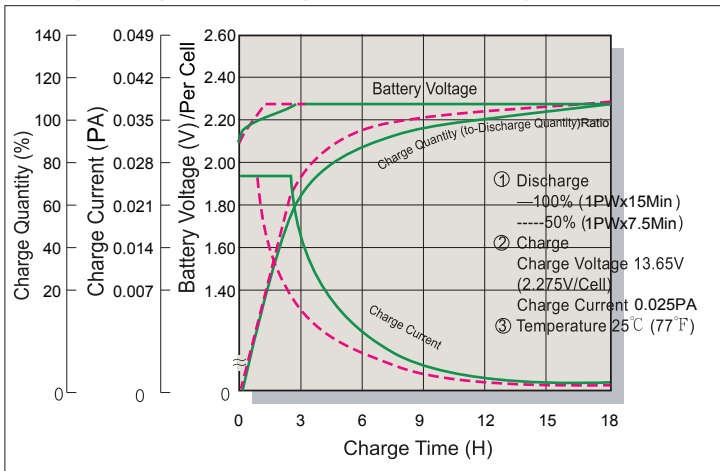

Cycle Service Life

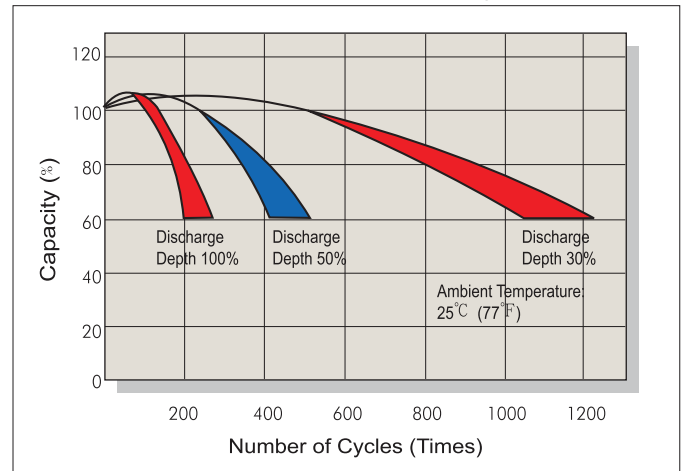

Battery Voltage and Charge Time for Cycle Use

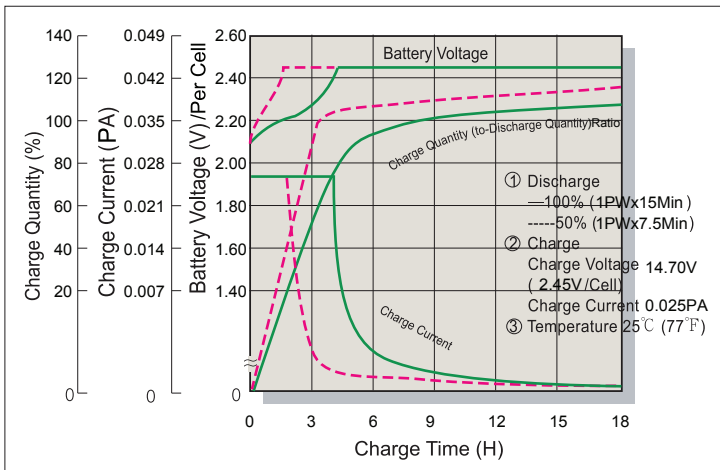

Terminal Voltage (V) and Discharge Time

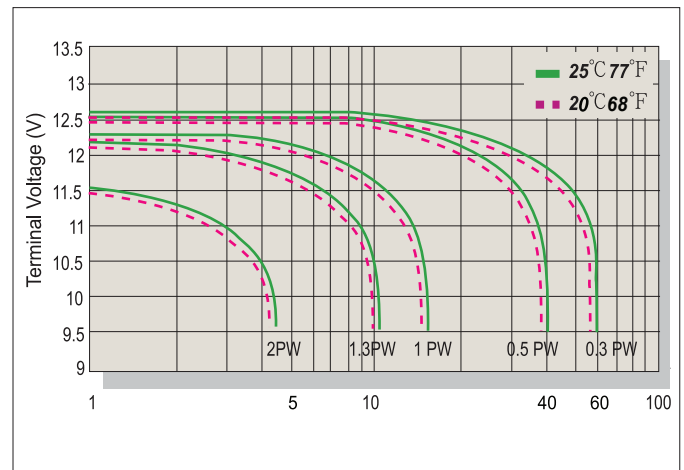

Charging Procedures

Application	Charge Voltage(V/Cell)			Max.Charge Current
	Temperature	Set Point	Allowable Range	
Cycle Use	25°C(77°F)	2.45	2.40~2.50	0.1PA
Standby	25°C(77°F)	2.275	2.25~2.30	

Discharge Current VS. Discharge Voltage

Final Discharge Voltage V/Cell	1.75	1.70	1.60	1.30
Discharge Power(W)	0.1P>(W)	0.1P≤(W)<0.25P	0.25P≤(W)<1.0P	(W)≥1.0P

Sales Office URL: WWW.CSB-BATTERY.COM

GLOBAL HQ
CSB BATTERY CO., LTD. (TAIWAN)
 Tel : +886-2-2880-5600
 Fax : +886-2-2888-3300
 mail : service@csb-battery.com.tw

BEIJING OFFICE. (CHINA)
CSB BATTERY TECHNOLOGIES (BEIJING) CO., LTD.
 Tel : +86-10-5820-5336/5338
 Fax : +86-10-58203053
 mail : chinasl@csb-battery.com

AMERICA HQ
CSB BATTERY TECHNOLOGIES INC. (U.S.A)
 Tel : +1-817-244-7777/1-(800)3-CSB-USA(272872)
 Fax : +1-817-244-4445
 mail : csb@csb-battery.com

SHANGHAI OFFICE. (CHINA)
CSB BATTERY LOGISTIC (SHANGHAI) CO., LTD.
 Tel : +86-21-5046-1622/5046-0833
 Fax : +86-21-5064-1046
 mail : chinasl@csb-battery.com

EUROPE HQ
CSB Battery Europe BV.
 Tel : +31(0)-180-418-140
 Fax : +31(0)-180-418-327
 mail : eurosales@csb-battery.eu

SHENZHEN OFFICE. (CHINA)
CSB BATTERY LOGISTIC (SHANGHAI) CO., LTD.
 Tel : +86-755-8831-6488/6396/6356
 Fax : +86-755-8831-6548
 mail : she@csb-battery.com.cn