

Powered by



GPL 1272 ▶ 12V 7.2Ah

GPL 1272 is a general purpose battery up to 8 years in standby service or more than 260 cycles at 100% discharge in cycle service . As with all CSB batteries, all are rechargeable , highly efficient , leak proof and maintenance free.



► Specification

Cells Per Unit	6
Voltage Per Unit	12
Capacity	7.2Ah @ 20hr-rate to 1.75V per cell @25°C (77°F)
Weight	Approx. 2.6 kg(5.73 lbs)
Maximum Discharge Current	100A/130A(5sec)
Internal Resistance	Approx. 21 mΩ
Operating Temperature Range	Discharge: -15°C~50°C (5°F~122°F) Charge: -15°C~40°C (5°F~104°F) Storage: -15°C~40°C (5°F~104°F)
Nominal Operating Temperature Range	25°C±3°C (77°F±5°F)
Float Charging Voltage	13.5 to 13.8 VDC/unit Average at 25°C (77°F)
Recommended Maximum Charging Current Limit	2.16A
Equalization and Cycle Service	14.4 to 15.0 VDC/unit Average at 25°C (77°F)
Self Discharge	CSB Batteries can be stored for more than 6 months at 25°C (77°F). Please charge batteries before using . For higher temperatures the time interval will be shorter .
Terminal	F1/F2-Faston Tab187/250
Container Material	ABS(UL 94-HB) & Flammability resistance of (UL 94-V0) can be available upon request.



CSB-manufactured **VRLA** (Absorbent **G**lass **M**at type) batteries are UL-recognized components under UL1989.

CSB is also certified by ISO 9001 and ISO 14001.

► Dimensions :	Overall Height (H)	Container height (h)	Length (L)	Width (W)
Unit: mm (inch)	98.6±1.5 (3.88±0.06)	94.3±1 (3.71±0.04)	151±2 (5.94±0.08)	64.8±1 (2.55±0.04)

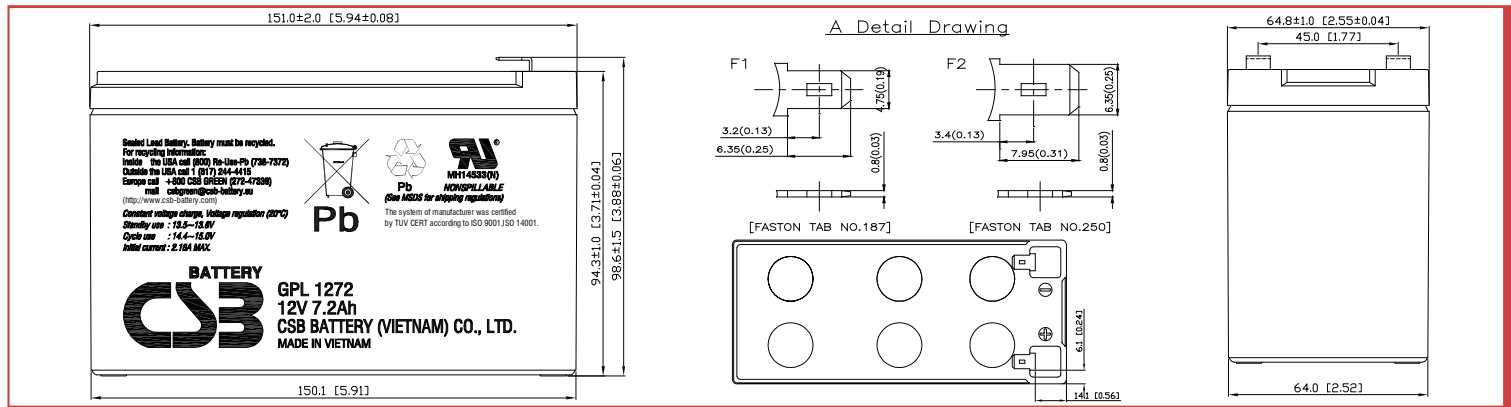

Constant Current Discharge Characteristics Unit:A (25°,77°F)

F.V/Time	5MIN	10MIN	15MIN	30MIN	60MIN	90MIN	2HR	3HR	5HR	8HR	10HR	20HR
1.60V	24.1	19.2	15.6	9.05	4.87	3.43	2.67	1.93	1.29	0.90	0.73	0.37
1.67V	23.1	18.3	14.9	8.80	4.72	3.33	2.60	1.89	1.28	0.88	0.72	0.36
1.70V	22.6	17.8	14.5	8.68	4.65	3.28	2.56	1.87	1.27	0.87	0.72	0.36
1.75V	21.8	17.0	13.9	8.45	4.52	3.20	2.50	1.82	1.23	0.86	0.70	0.36
1.80V	20.8	16.2	13.2	8.19	4.39	3.13	2.46	1.77	1.20	0.84	0.69	0.35
1.85V	19.6	15.3	12.5	7.87	4.27	3.04	2.39	1.74	1.16	0.82	0.67	0.34

Constant Power Discharge Characteristics Unit:W (25°C,77°F)

F.V/Time	5MIN	10MIN	15MIN	30MIN	60MIN	90MIN	2HR	3HR	5HR	8HR	10HR	20HR
1.60V	258	210	173	103	54.0	38.1	29.8	22.0	15.3	10.5	8.78	4.46
1.67V	251	202	166	101	53.3	37.4	29.1	21.8	15.0	10.4	8.64	4.40
1.70V	247	199	162	99.3	52.9	37.1	28.8	21.6	14.9	10.2	8.57	4.36
1.75V	240	192	156	97.4	52.3	36.5	28.2	21.2	14.5	10.1	8.45	4.28
1.80V	231	185	151	95.0	51.5	35.8	27.7	20.8	14.1	10.0	8.29	4.20
1.85V	222	177	146	92.2	50.6	35.2	27.2	20.4	13.8	9.72	8.14	4.12

Ratings presented herein are subject to revision without notice. Please refer to www.csb-battery.com to confirm the latest version.

Trickle (or Float) Service Life

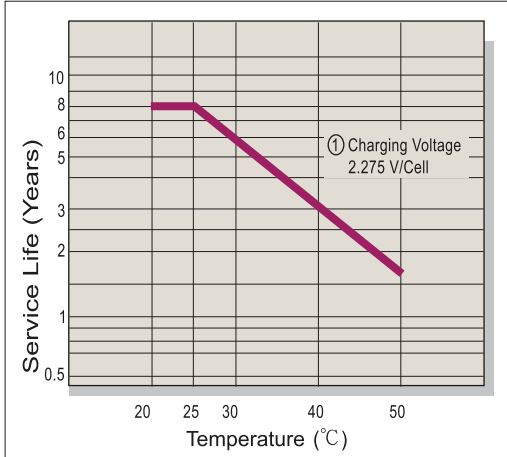

Capacity Retention Characteristic

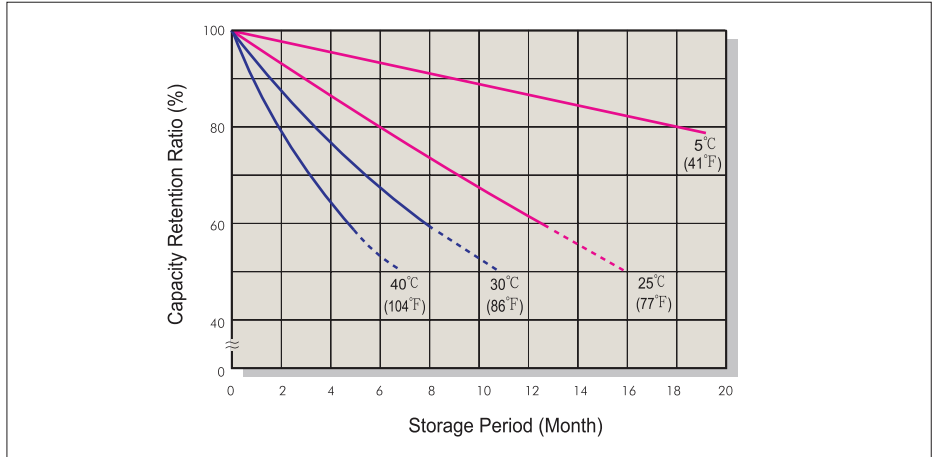

Battery Voltage and Charge Time for Standby Use

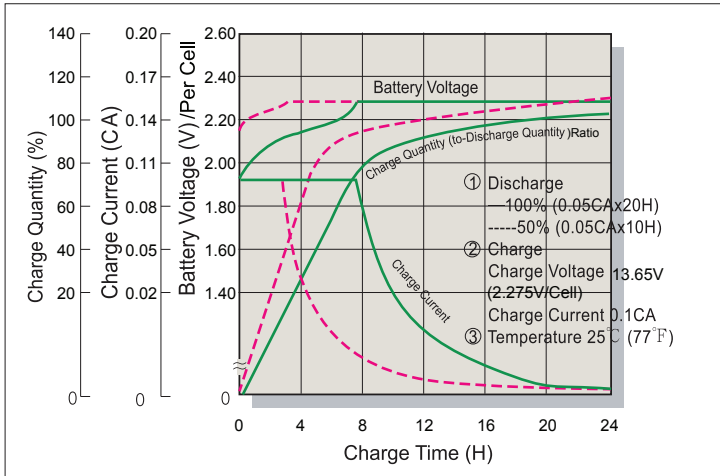

Cycle Service Life

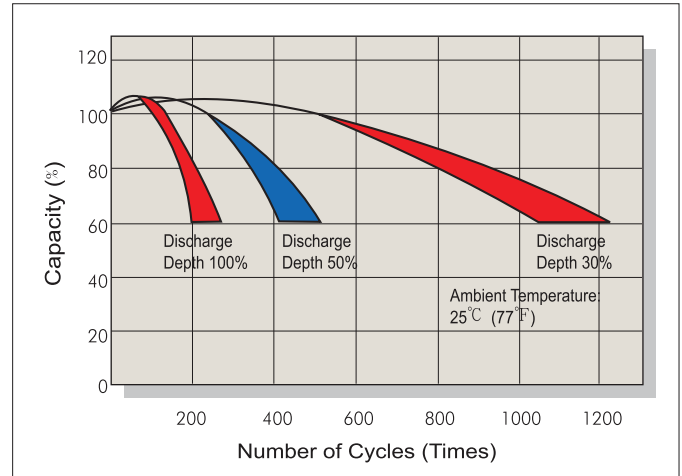

Battery Voltage and Charge Time for Cycle Use

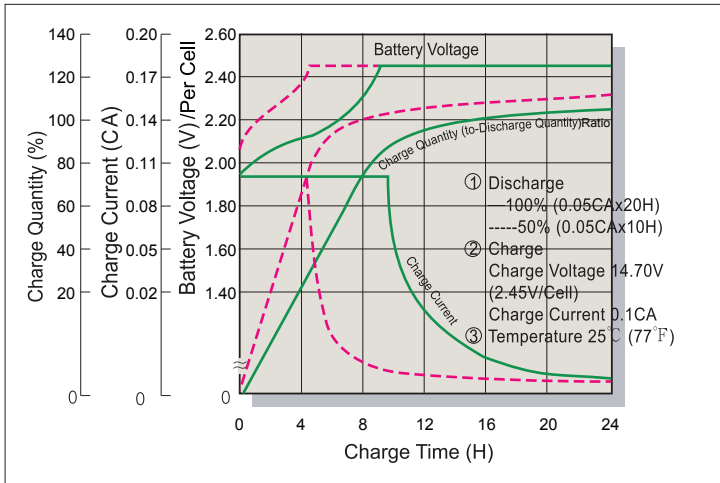

Terminal Voltage (V) and Discharge Time

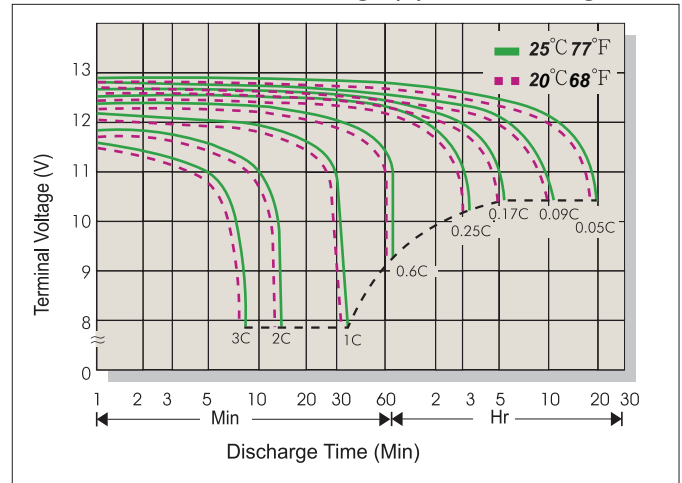

Charging Procedures

Application	Charge Voltage(V/Cell)			Max.Charge Current
	Temperature	Set Point	Allowable Range	
Cycle Use	25°C(77°F)	2.45	2.40~2.50	0.3C
Standby	25°C(77°F)	2.275	2.25~2.30	

Discharge Current VS. Discharge Voltage

Final Discharge Voltage V/Cell	1.75	1.70	1.60	1.30
Discharge Current(A)	0.2C>(A)	0.2C<(A)<0.5C	0.5C<(A)<1.0C	(A)>1.0C

Sales Office URL: WWW.CSB-BATTERY.COM

GLOBAL HQ CSB BATTERY CO., LTD. (TAIWAN)

Tel : +886-2-2880-5600
Fax : +886-2-2888-3300
mail : service@csb-battery.com.tw

BEIJING OFFICE. (CHINA)

CSB BATTERY TECHNOLOGIES (BEIJING) CO., LTD.
Tel : +86-10-5820-5336/5338
Fax : +86-10-58203053
mail : chinasls@csb-battery.com

AMERICA HQ

CSB BATTERY TECHNOLOGIES INC. (U.S.A)
Tel : +1-817-244-7777/1-(800)3-CSB-USA(272872)
Fax : +1-817-244-4445
mail : csb@csb-battery.com

SHANGHAI OFFICE. (CHINA)

CSB BATTERY LOGISTIC (SHANGHAI) CO., LTD.
Tel : +86-21-5046-1622/5046-0833
Fax : +86-21-5064-1046
mail : chinasls@csb-battery.com

EUROPE HQ

CSB Battery Europe BV.
Tel : +31(0)-180-418-140
Fax : +31(0)-180-418-327
mail : eurossales@csb-battery.eu

SHENZHEN OFFICE. (CHINA)

CSB BATTERY LOGISTIC (SHANGHAI) CO., LTD.
Tel : +86-755-8831-6488/6396/6356
Fax : +86-755-8831-6548
mail : she@csb-battery.com.cn