

IND060SIP Hornet: Non-Isolated DC-DC Voltage Regulator Modules

12Vdc input; 0.6Vdc to 5.5Vdc output; 60W Max Power

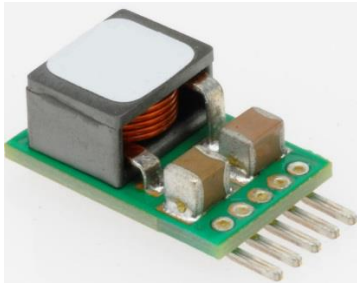

Applications

- ✓ Industrial Equipment
- ✓ Control Boards
- ✓ Test Equipment

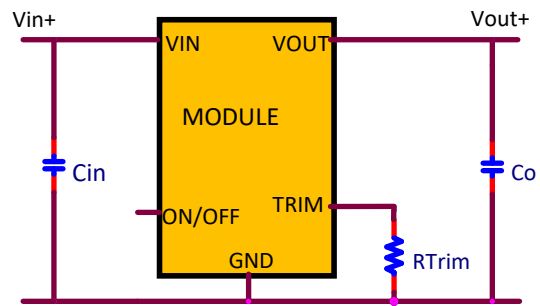

Electrical Features

- 12V Input voltage with wide Tolerance
- Output voltage programmable from 0.59Vdc to 5.5Vdc via external resistor
- Remote On/Off for optional external control
- Fixed switching frequency
- Output overcurrent protection (non-latching)

Mechanical Features

- Small size: 10.4 mm x 16.5 mm x 8.4 mm (0.41 in x 0.65 in x 0.33 in)
- Operating range: -40°C to 85°C ambient

Process and Safety

- ANSI/UL* 62368-1 and CAN/CSA† C22.2 No. 62368-1 Recognized, DIN VDE‡ 0868-1/A11:2017 (EN62368-1:2014/A11:2017)
- ISO** 9001 and ISO 14001 certified manufacturing facilities
- Compliant to RoHS Directive 2011/65/EU and amended Directive (EU) 2015/863
- Compliant to REACH Directive (EC) No 1907/2006
- Compatible in a Pb-free or SnPb reflow environment.
- Suitable for aqueous clean.
- Suitable for conformal coating with dip and vapor deposition. Conformal coating can provide the protection to meet Salt Fog Test per IEC 60068-2-52 (Severity 3) and Mixed Gas Flow test per Telcordia GR-3108 Outdoor Levels.
- 3 year warranty

Device Code	Input Voltage	Output Voltage	Output Current (Max.)	On/Off Logic	Comcode
IND060SIP	9.6 – 14Vdc	0.59 – 5.5Vdc	10A	Positive	1600102908A

Thermal Performance

Full rated output with natural convection up to 40°C at 0.6Vout and up to 45°C at 6Vout.. Thermal curves for 0.6V, 1.8V and 5.5Vout below.

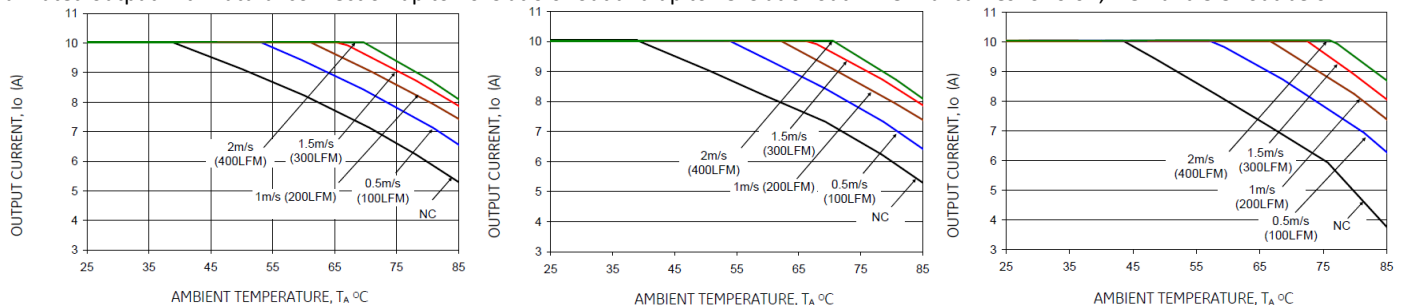

Electrical Specifications

Parameter	Device	Symbol	Min	Typ	Max	Unit
Operating Input Voltage	All	V _{IN}	9.6	12	14	Vdc
Input No Load Current (V _{IN} = 12.0Vdc, I _o = 0, module enabled)	V _{O,set} = 0.6 Vdc	I _{IN,No load}		29		mA
	V _{O,set} = 5Vdc	I _{IN,No load}		58		mA
External Capacitance, Ceramic ESR ≥ 1 mΩ	All	C _{O,max}	100	—	1500	μF
Efficiency 12V _{INDC} , T _A =25°C, I=12A, V _o =0.6 to 3.3Vdc		η	73(0.59V), 87(1.8V), 95(6V)			%
Switching Frequency	All	f _{sw}	—	600	—	kHz
Output Voltage (Over all line, load, and temperature conditions)	All	V _{O, set}	-3.0	—	+3.0	% V _{O, set}
On/Off Logic High (MODULE ON) Input High Voltage	All	V _{IH}	1	—	14	Vdc
On/ Off Logic Low (MODULE OFF) Input Low Voltage	All	V _{IL}	-0.3	—	0.4	Vdc

Characteristic Curves

The following figures provide typical characteristics for the 10A Hornet at 25°C.

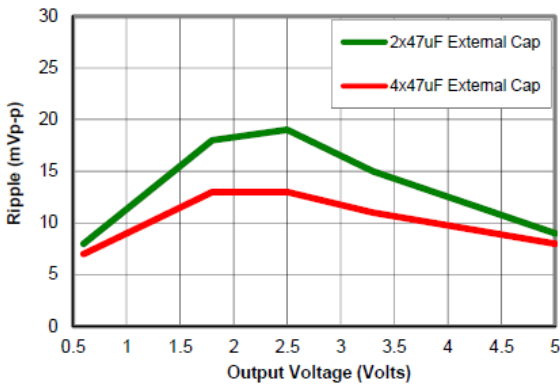

Figure 1. Output Ripple Voltage (20MHz BW) for various output voltages and external caps @12Vin. Additional Decoupling cap of 0.1uF used on input and output side

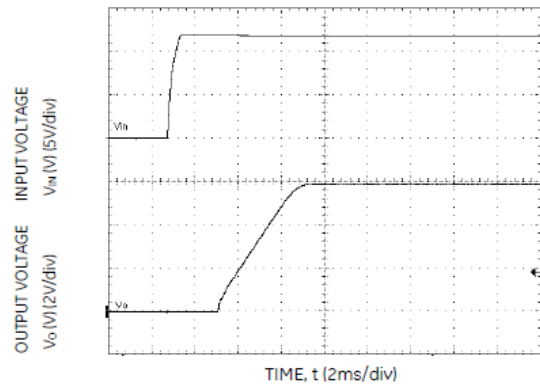

Figure 2. Typical Start-up using Input Voltage (Vin=12V, Vout = Vout, max, Iout = Iout, max)

Trim

Without an external resistor between Trim and GND pins, the output of the module will be 0.6Vdc. R_{trim} for a desired output voltage, should be as per the following table. The formula in the last column helps determine R_{trim} for other voltages.

V _o (V)	0.59	1.0	1.2	1.5	1.8	2.5	3.3	5.0	$R_{trim} = \left[\frac{1.182}{(V_o - 0.591)} \right] k\Omega$
R _{trim} (kΩ)	Open	2.89	1.941	1.3	0.978	0.619	0.436	0.268	

Safety Considerations

For safety agency approval, the power module must be installed in compliance with the spacing and separation requirements of the end-use safety agency standards listed on the first page of this document. For the converter output to be considered meeting the requirements of safety extra-low voltage (SELV) or ES1, the input must meet SELV/ES1 requirements. The power module has extra-low voltage (ELV) outputs when all inputs are ELV. A 15A quick acting input fuse for the module is required.

Recommended Pad Layout

Dimensions are in millimeters and (inches).

Tolerances: x.x mm ± 0.5 mm (x.xx in. ± 0.02 in.) [unless otherwise indicated] x.xx mm ± 0.25 mm (x.xxx in ± 0.010 in.)

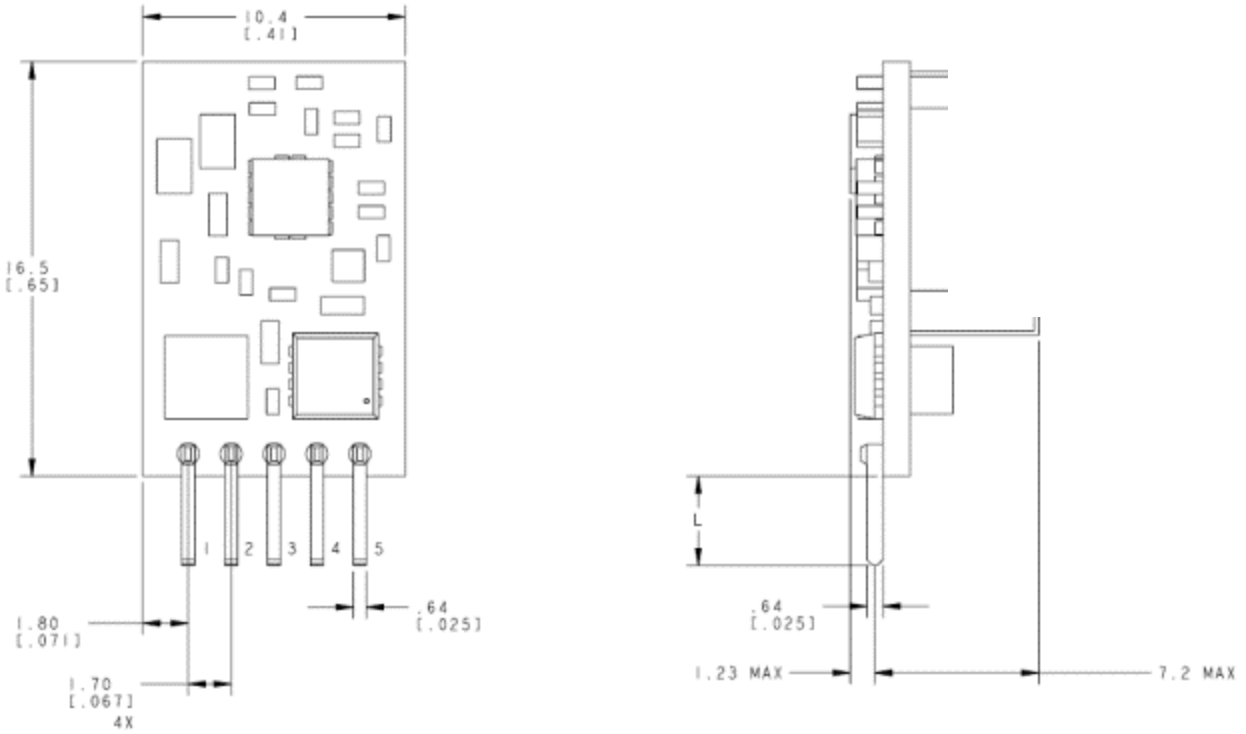

Pin	Function
1	On/Off
2	V _{IN}
3	GND
4	V _{out}
5	Trim+

$L = 3.29 [0.13] \pm 0.25 [0.112 \pm 0.01]$

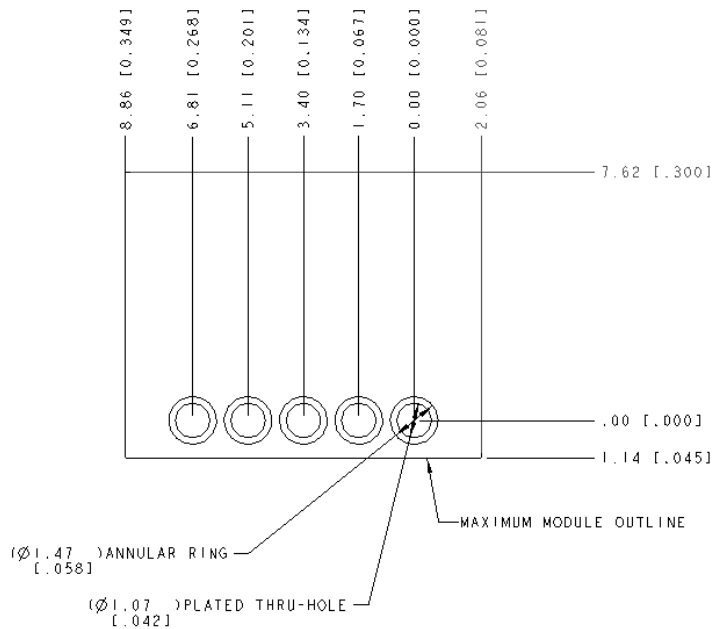

Through-Hole Lead-Free Soldering Information

These RoHS-compliant through-hole products use the SAC (Sn/Ag/Cu) Pb-free solder and RoHS-compliant components. They are designed to be processed through single or dual wave soldering machines. The pins have an RoHS-compliant finish that is compatible with both Pb and Pb-free wave soldering processes. A maximum preheat rate of 3°C/s is suggested. The wave preheat process should be such that the temperature of the power module board is kept below 210°C. For Pb solder, the recommended pot temperature is 260°C, while the Pb-free solder pot is 270°C max. Not all RoHS-compliant through-hole products can be processed with paste-through-hole Pb or Pb-free reflow process.

Ihr Vertriebspartner:



HY-LINE Power Components
Vertriebs GmbH
Inselkammerstr. 10
D-82008 Unterhaching
☎ +49 89/ 614 503 -10
power@hy-line.de

HY-LINE AG

Hochstrasse 355
CH-8200 Schaffhausen
☎ +41 52 647 42 00
info@hy-line.ch



Contact Us

For more information, call us at

USA/Canada:

+1 888 546 3243, or +1 972 244 9288

Asia-Pacific:

+86-21-53899666

Europe, Middle-East and Africa:

+49.89.878067-280

[Go.ABB/Industrial](#)

GE Critical Power reserves the right to make changes to the product(s) or information contained herein without notice, and no liability is assumed as a result of their use or application. No rights under any patent accompany the sale of any such product(s) or information.