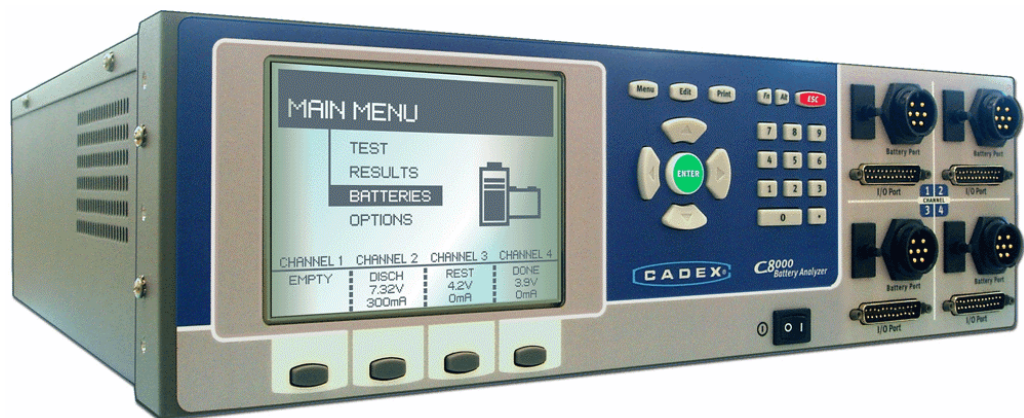


---

# C8000 Battery Testing System

## User Manual (V2.x)



**Cadex® Electronics Inc.**

22000 Fraserwood Way  
Richmond, British Columbia  
Canada V6W 1J6

Phone: 1-604-231-7777

FAX: 1-604-231-7755

Web: [www.cadex.com](http://www.cadex.com)

E-mail: [info@cadex.com](mailto:info@cadex.com)

## **Trademark**

Cadex® and BatteryLab® are registered trademarks of Cadex Electronics Inc. All other trademarks or registered trademarks mentioned herein are the property of their respective owners.

## **Copyright Notice**

Copyright © 2010 by Cadex Electronics Inc. All rights reserved. No part of this publication nor the software and/or firmware controlling Cadex product(s) may be reproduced, transmitted, transcribed, stored in a retrieval system, or translated into any language or computer language in any form or by any means without the express written permission of Cadex Electronics Inc.

## **Revision Rights**

Cadex Electronics Inc. reserves the right to revise this publication and make changes in the contents thereof without obligation to notify any person of such changes. Please contact Cadex Electronics Inc. ([service@cadex.com](mailto:service@cadex.com)) for suggestions or corrections.

## **Disclaimer**

While every effort is made to ensure that the information contained in this manual and Online Help is accurate and up-to-date, Cadex Electronics Inc. does not warrant or guarantee the accuracy of the contents of this manual and Online Help. Further, Cadex makes no warranties, either expressed or implied, as to the merchantability or fitness for a particular purpose of the C8000 Battery Testing System and/or its documentation.

In no event will Cadex or its officers or employees are responsible for any consequential, incidental, or indirect damages (including damages for loss or business profits, business interruption, and the like) arising out of the use or inability to use the C8000 Battery Testing System and/or its documentation.

# Contents

<b>Contents .....</b>	<b>i</b>
<b>1 Safety and Warranty .....</b>	<b>1</b>
1.1 Cautions and Warnings .....	1
1.1.1 Use of Equipment .....	1
1.1.2 Modification of Equipment.....	1
1.1.3 Hazard Symbols .....	2
1.1.4 Disposal of Waste Electrical and Electronic Equipment (WEEE) in the European Union	3
1.1.5 Radio Interference.....	3
1.1.6 Explosion Hazard.....	4
1.1.7 Charge and Discharge Lithium-ion (Li-ion) Batteries.....	5
1.1.8 Shock Hazard.....	6
1.2 Warranty and Service.....	7
1.2.1 Warranty Service .....	7
1.2.2 Non Warranty Repairs .....	8
1.3 Back Up and Restore Calibration Data.....	8
1.3.1 Back Up Calibration Data.....	8
1.3.2 Restore Calibration Data.....	8
<b>2 Battery Tester.....</b>	<b>10</b>
2.1 Getting Started with the Battery Tester .....	10
2.1.1 The C8000 Battery Tester User Manual .....	10
2.1.1.1 Topics You Need to Know .....	10
2.1.2 What is in the Box.....	11
2.1.3 Optional C8000 Accessories.....	12
2.1.3.1 C8000 Adapter Unit.....	12

2.1.3.2	RigidArm™ Universal Battery Adapter .....	13
2.1.3.3	SnapLock™ Universal Battery Adapter (4-wire versions only).....	13
2.1.3.4	Load Capture Unit (LCU).....	13
2.2	Display and Controls.....	14
2.2.1	Front Panel.....	14
2.2.1.1	LCD Settings.....	14
2.2.1.2	Channel Key Buttons .....	14
2.2.1.3	Arrow and ENTER Buttons .....	15
2.2.1.4	Navigating the LCD Display .....	15
2.2.1.5	Numeric Keypad.....	15
2.2.1.6	Battery Port Connections .....	16
2.2.2	Back Panel .....	17
2.2.2.1	AC Input.....	17
2.2.2.2	Ethernet Port .....	17
2.2.2.3	Serial Ports and USB Port.....	17
2.2.2.4	Cooling Fans .....	18
2.3	Cadex C8000 Adapter Unit.....	18
2.3.1	Cadex C8000 Adapter Unit.....	18
2.3.2	Connect the C8000 Adapter Unit to the C8000.....	19
2.4	Cables.....	20
2.4.1	Power Port Cable .....	20
2.4.2	Connect the Power Port Cable to the C8000 .....	20
2.4.3	Auxiliary data cables (for I/O ports).....	23
2.5	C8000 Specifications .....	26
2.5.1	C8000 System Technical Specifications.....	26
2.5.2	Auxillary Port Absolute Maximum Ratings .....	28
2.5.3	Auxillary Port Operating Ratings .....	29
2.6	Configure the C8000.....	30
2.6.1	Set Up the C8000 .....	30
2.7	User Maintenance for the C8000 .....	30
2.7.1	User Maintenance Warnings.....	30
2.7.2	Clean the C8000.....	31
2.7.3	Replace the Fuse .....	31

2.7.4	Replace the Backup Battery .....	32
2.8	The Battery Tester Application.....	35
2.8.1	Execute a Program on a Battery.....	36
2.8.1.1	Execute a Program without BatteryLab.....	36
2.8.1.2	Suspend and Resume a Running Program.....	39
2.8.1.3	Abort a Running Program.....	39
2.8.1.4	View Auxiliary Port Information.....	40
2.8.1.5	Jump to a Specific Program Step.....	41
2.8.1.6	View SM-Bus Information .....	42
2.8.1.7	Select a Program to Run .....	43
2.8.2	Test Results.....	45
2.8.2.1	View Test Results .....	45
2.8.2.2	Print Test Results .....	46
2.8.2.3	Delete a Test Result .....	46
2.8.2.4	Delete All Test Results .....	47
2.8.3	Battery Profiles .....	48
2.8.3.1	View and Edit a Battery Profile.....	49
2.8.3.2	Delete a Battery Profile.....	51
2.9	C-Codes.....	52
2.9.1	Add, Edit, and Delete C-Codes.....	52
2.9.1.1	Create a C-Code.....	53
2.9.1.2	View and Edit a C-Code .....	53
2.9.1.3	Delete a C-Code.....	56
2.9.2	Import a C-Code .....	57
2.9.3	Export a C-Code .....	58
2.10	Programs .....	59
2.10.1	View a Custom Program.....	59
2.10.2	Delete a Custom Program .....	60
2.11	Waveforms.....	61
2.11.1	View Information about a Waveform.....	61
2.11.2	Delete a Waveform .....	62
2.12	Specify System Options.....	63
2.12.1	Set the Clock.....	63

2.12.2	User Information.....	64
2.12.3	LCD Settings.....	65
2.12.4	Serial Ports.....	65
2.12.5	Specify the TCP/IP Address on the C8000.....	66
2.12.6	Maintenance.....	67
2.12.7	Options.....	67
2.12.8	Security.....	69
2.12.9	System Information.....	70
2.12.10	Factory Defaults.....	72
2.13	External Devices.....	73
2.13.1.1	Programmable DC Electronic Loads.....	73
2.13.1.2	Thermal Chambers.....	73
<b>3</b>	<b>Cadex BatteryLab.....</b>	<b>74</b>
3.1	System Setup.....	74
3.1.1	System Requirements.....	74
3.1.2	Set Windows Explorer and My Computer to Display File Extensions.....	75
3.1.3	Create a Database for BatteryLab.....	75
3.1.4	Back Up the Data Files on the PC.....	76
3.1.5	Install and Uninstall BatteryLab.....	76
3.1.5.1	Install BatteryLab.....	77
3.1.5.2	Uninstall BatteryLab.....	80
3.1.6	Software Updates.....	81
3.1.6.1	Software Version.....	81
3.1.6.2	Update BatteryLab Software.....	81
3.1.7	BatteryLab Security Information.....	82
3.1.8	Set Up BatteryLab.....	82
3.1.8.1	Connect the C8000 to the Network.....	83
3.1.8.2	Set Up the C8000 to Use BatteryLab.....	83
3.1.8.3	Choose IP Addresses for the Local Network.....	83
3.1.8.4	Find the IP Address for Your PC.....	84
3.1.8.5	TCP/IP Settings.....	84
3.1.8.6	Network Cable.....	85
3.1.9	Firewalls.....	85

3.1.9.1	Ports .....	86
3.1.9.2	Other Firewall Software or Hardware.....	86
3.1.10	Selecting a TCP/IP Address for the C8000.....	86
3.1.10.1	Before Entering the Settings .....	86
3.1.10.2	Ping the Network to Check for Available IP address .....	88
3.1.10.3	Add IP Addresses for C8000s on the PC .....	88
3.1.10.4	Disable an IP address .....	90
3.1.11	Start the BatteryLab Program .....	90
3.1.11.1	The Menu Bar .....	90
3.1.12	Set the Clock on the C8000 .....	92
3.1.13	Set Security Setting on the C8000 .....	93
3.1.14	Set the Password to Configure C8000 Functions .....	94
3.1.15	C8000 Settings .....	94
3.1.16	Alert Window.....	96
3.1.17	Exit BatteryLab.....	97
3.2	Configure BatteryLab .....	98
3.2.1	Results Panel.....	98
3.2.2	Event Logging.....	101
3.2.3	Report Template Options .....	102
3.2.4	Graph Options.....	102
3.3	View Battery Status in Real-Time .....	104
3.4	Test Batteries with BatteryLab .....	108
3.4.1	View the Status of a Test in BatteryLab .....	110
3.4.1.1	Background Color of Tests Running .....	110
3.4.2	Cancel or Suspend a Test in BatteryLab.....	111
3.4.2.1	Cancel a Test.....	111
3.4.2.2	Suspend a Test .....	111
3.4.2.3	Resume a Suspended Test.....	111
3.4.2.4	Simulate a Battery Removal .....	111
3.4.3	Retrieve Test Results from the C8000 .....	111
3.5	Test Status .....	112
3.6	View Test Results in BatteryLab .....	113
3.6.1	Import Test Results .....	114

---

3.6.2	Print a Search List.....	114
3.6.3	View and Print Test Details .....	115
3.6.3.1	Edit a Test Result Record .....	116
3.6.3.2	Delete a Battery Test Record .....	117
3.6.3.3	Print Test Result Document .....	117
3.6.3.4	View Details.....	118
3.6.3.5	View Program Steps .....	118
3.6.3.6	View a Battery Test Graph .....	119
3.6.3.7	View C-Code Information .....	119
3.6.3.8	Custom Waveform.....	120
3.6.3.9	Playback a Waveform.....	120
3.6.3.10	Load Capture Waveform.....	121
3.6.3.11	View Termination Data.....	121
3.6.3.12	Cycle Graph .....	122
3.6.3.13	Print Results .....	123
3.6.3.14	Print a Battery Test Graph .....	123
3.6.3.15	Export Test Record Results to a File .....	123
3.6.3.16	Export Graph Data To a File.....	124
3.6.3.17	Export Termination Data to a File .....	125
3.7	Reports .....	125
3.7.1	Print Battery Test Reports.....	125
3.7.2	Add, Edit, and Delete Report Templates .....	125
3.7.2.1	Add a Report Template:.....	125
3.7.2.2	Edit a Report Template: .....	127
3.7.2.3	Set the Default Report Template.....	128
3.7.2.4	Delete a Report Template .....	129
3.7.2.5	Copy a Report Template .....	130
3.7.2.6	Set Up Your Printer .....	132
3.8	Battery ID Database.....	134
3.8.1	Add a Battery ID.....	134
3.8.2	Edit a Battery ID.....	135
3.8.3	Delete a Battery ID .....	136
3.8.4	Copy a Battery ID.....	138



3.8.5	Import a Battery ID.....	139
3.8.6	Export a Battery ID.....	143
3.8.7	Search for a Battery ID.....	147
3.8.8	Sort Battery IDs.....	147
3.9	C-Code.....	147
3.9.1	Add a C-Code.....	147
3.9.2	Add a SM-BUS (Smart Battery) C-Code.....	148
3.9.3	Edit a C-Code.....	152
3.9.4	Delete a C-Code.....	153
3.9.5	Copy a C-Code.....	155
3.9.6	Import a C-Code.....	156
3.9.7	Export a C-Code.....	160
3.9.8	Search for a C-Code.....	164
3.9.9	Sort the C-Codes.....	164
3.10	Programs.....	164
3.10.1	Factory Default Programs.....	165
3.10.2	A Custom-Program Example.....	171
3.10.3	A Custom-Program with Thermal Chamber Example.....	175
3.10.4	Add a Program.....	183
3.10.4.1	Add a Step to a Program.....	184
3.10.4.2	Remove a Step from a Program.....	193
3.10.4.3	Copy a Step in a Program.....	193
3.10.4.4	Save the Custom Program.....	193
3.10.5	Add Folders.....	194
3.10.6	Edit a Program.....	195
3.10.7	Delete a Program.....	196
3.10.8	Copy a Program.....	199
3.10.9	Organize Programs in Folders.....	202
3.10.10	Import a Program.....	203
3.10.11	Export a Program.....	207
3.10.12	Search for a Program.....	210
3.10.13	Sort Programs and Folders.....	210
3.11	Load Capture.....	211

---

3.11.1	Load Capture Programs Database.....	215
3.11.2	Add a Load Capture Program .....	215
3.11.3	Edit a Load Capture Program .....	216
3.11.4	Delete a Load Capture Program.....	218
3.11.5	Copy a Load Capture Program .....	219
3.11.6	Import a Load Capture Program .....	221
3.11.7	Export a Load Capture Program .....	222
3.11.8	Search for a Load Capture Program.....	224
3.11.9	Sort the Load Capture Programs.....	224
3.12	Waveforms.....	224
3.12.1	Sample Custom Waveform.....	224
3.12.2	Add a Waveform.....	228
3.12.2.1	Add a Step to a Waveform.....	230
3.12.2.2	Remove a Step from a Waveform.....	230
3.12.2.3	Copy a Step to Another Step in a Waveform.....	230
3.12.2.4	Move the Order of Steps in a Waveform .....	231
3.12.3	Organize Waveforms in Folders .....	231
3.12.4	Edit a Waveform.....	233
3.12.5	Delete a Waveform .....	234
3.12.6	Copy a Waveform.....	235
3.12.7	Import a Waveform.....	237
3.12.8	Export a Waveform.....	240
3.12.9	Search for a Waveform .....	244
3.12.10	Sort the Waveforms .....	244
3.13	Sequences.....	244
3.13.1	Add a Program Sequence.....	245
3.13.2	Edit a Program Sequence .....	246
3.13.3	Delete a Program Sequence .....	248
3.13.4	Copy a Program Sequence .....	249
3.13.5	Import a Program Sequence.....	251
3.13.6	Export a Program Sequence.....	255
3.13.7	Search for a Program Sequence .....	259
3.13.8	Sort Program Sequences .....	259

3.14	System Updates.....	260
3.14.1	Firmware Information.....	260
3.14.1.1	Update the Firmware on the C8000s .....	260
3.14.1.2	Update the Calibration Data.....	262
3.15	Troubleshooting .....	263
3.15.1.1	Communication Issues .....	263
3.15.1.2	Frozen Keyboard and LCD Display .....	263
3.15.1.3	Check IP Addresses .....	263
3.15.1.4	DAO Error .....	263
3.15.1.5	Corrupt Database .....	264
3.15.1.6	Folder Access Permissions .....	264
3.15.1.7	Set Access Permissions in Windows XP .....	264
3.15.1.8	Error Writing to the Log File .....	265
<b>4</b>	<b>C-Code Parameters.....</b>	<b>266</b>
<b>5</b>	<b>Status Messages.....</b>	<b>273</b>
5.1	Status Messages Listed by Code.....	273
5.2	Status Messages Listed by Detailed Message.....	278
<b>6</b>	<b>Glossary of Terms .....</b>	<b>281</b>



# 1 Safety and Warranty

---

## 1.1 Cautions and Warnings

---

### 1.1.1 Use of Equipment

The C8000 Battery Testing System is designed with adequate safeguards to protect you from shock and other hazards when used as specified within this document. However, if the equipment is used in a manner not specified by this documentation, the protection provided by this equipment may be impaired. Please read this document and equipment labeling before using the equipment.

---

### 1.1.2 Modification of Equipment

CE, FCC, Safety Agency, and other approvals apply only to the C8000 Battery Testing System in the factory-authorized configuration. Changes or modification to the equipment not expressly approved by Cadex will void the approvals and void your authority to operate the equipment.

### 1.1.3 Hazard Symbols

The following symbols are used to warn of potential hazards:



**Warning or Danger**

Information that, if ignored, can result in serious injury or death.



**Caution**

Information that, if ignored, can result in damage to the C8000 Battery Testing System, battery adapters, or the battery.





**Potential Electrical Shock Hazard**




**Potential Explosion Hazard**

### 1.1.4 Disposal of Waste Electrical and Electronic Equipment (WEEE) in the European Union

 	<p>This symbol on the product and package indicates that this product must not be disposed of with unsorted municipal waste. Instead, it is your responsibility to dispose of WEEE by handing it over to a designated collection point for the disposal.</p> <p>The separate collection and recycling of waste equipment will help conserve natural resources and ensure that it is disposed of in a manner that protects human health and the environment. For more information about where to drop off waste equipment for disposal, please contact your local municipal office, waste disposal service, or wherever you purchased the product.</p>
--	---

### 1.1.5 Radio Interference

 <p><b>Caution</b></p> <p><b>This equipment generates, uses, and radiates radio frequency energy. If the equipment is not installed and used in accordance with the instructions in this manual, it may cause interference with radio communications.</b></p>
---

The equipment has been tested and found to comply with the limits for a Class “A” digital device pursuant to Subpart B of Part 15 of the FCC Rules, which are designed to provide reasonable protection against such interference when operated in a commercial environment. Operation of this equipment in a residential area may cause interference, in which case you must take whatever measures needed to correct the interference, at your own expense.

**EN55011/EN55022 Warning:** This is a Class A product according to EN55011/EN55022. In a domestic environment, this product may cause radio interference, in which case you must, at your expense, take adequate corrective measures.

The equipment is designed with adequate safeguards to protect the user from shock and other hazards when used as specified within this document. If the equipment is used in a manner not specified by this documentation, the protection provided by the equipment may be impaired. Please read the documentation and equipment labeling before using the equipment.

The equipment may be affected by interference from other devices. If the equipment is running abnormally, please ensure that the equipment is moved away from any source of radio interference.

### 1.1.6 Explosion Hazard



#### Warning

**Batteries can burst if treated improperly. Follow these precautions at all times:**

#### Do

- Clean battery contacts before servicing. To clean battery contacts, use a lint-free cotton swab dipped in 100% isopropyl alcohol.
- Press the battery firmly into the adapter.
- Observe battery temperature, which is displayed on the C8000 Status screen. Internal battery temperature must be between 5°C (41°F) and 50°C (122°F) during testing. Stop service if the battery's internal temperature exceeds 50°C. Allow cold batteries to warm up and hot batteries to cool before charging. The temperatures cited here are the battery temperatures, **not the ambient temperatures**. Fast charging outside this temperature range may damage or reduce the life of the battery.

#### Do Not

- Do not attempt to charge non-rechargeable and primary batteries such as alkaline, carbon-zinc, or non-rechargeable lithium batteries.
- Do not short the positive and negative battery terminals together at any time.
- Do not connect leads from one channel to another. Failing to follow the guidelines in this manual could result in venting with flame, explosion, fire and personal injury. An electrical short to any point outside the channel bypasses the current regulation loop and may blow a fuse or cause permanent component damage.



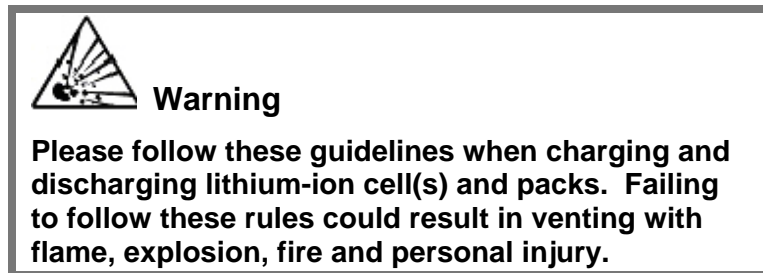
- Do not exceed the battery manufacturer's recommended charge current and voltage limits for batteries.
- Do not remove the battery from the adapter while the test is running. To minimize arcing, stop or cancel battery service before removing the battery from the adapter.

---

### 1.1.7 Charge and Discharge Lithium-ion (Li-ion) Batteries

Lithium-ion (Li-ion) batteries are safe when used as directed. Battery safety cannot be assured when a battery pack is built with individual cells of an unknown nature with a serial and parallel connection. Not all Li-ion cells are suited for multi-cell packs. Only cells that meet tight voltage and capacity tolerances can be used for serial and parallel connection. Mismatched packs are subject to overcharge resulting in venting with flame and fire. Check with the cell manufacturer to see if the cells are suitable for multi-cell packs.

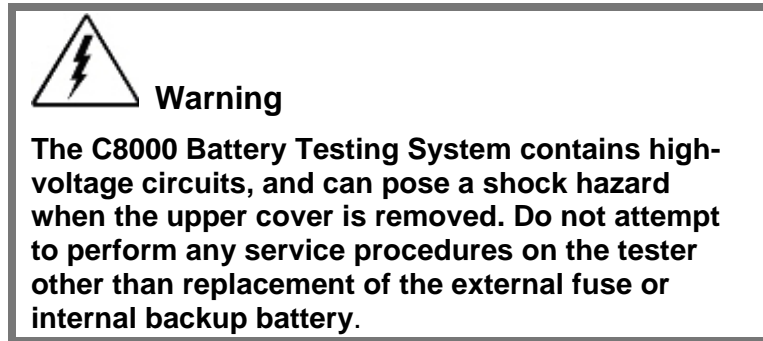
**In the past, single Li-ion cells were only available to authorized battery manufacturers. Today, imports are becoming readily available and often fall into the hands of the inexperienced. While most brand name cells are equipped with an internal cell disconnect that permanently opens the current path on high pressure, some brands do not provide this safeguard. Many brands don't use a separator that shuts down the battery when high temperatures are reached. The internal safety features are omitted for cost reasons.**



#### **Explosion Hazard**

- Never connect cells in parallel and/or series that are not designed for that purpose. A cell mismatch may overcharge and vent with flames.
- Never charge or discharge the battery without connecting a working protection circuit. Each cell must be monitored individually and the current disconnected if an anomaly occurs.
- Always attach a temperature sensor when charging and discharging the battery. The temperature sensor must disconnect the current on excess temperature.

### 1.1.8 Shock Hazard



#### **Shock Danger**

- To reduce the risk of electrical shock hazard, service batteries only when they are removed and disconnected from their end-use equipment.
- Use the tester only as specified in the documentation. Other uses may impair the protection provided by the unit.
- Use only a grounded AC outlet to power the tester.
- Before attempting any internal service, remove all batteries from the battery channels, turn the C8000 Battery Testing System off and disconnect the power cord from the wall socket. Wait a few minutes before opening the cover.
- Replace fuses only with fuses of the same type and rating.
- Replace the internal backup battery only with the same type of battery. Observe the correct polarity when installing the backup battery. Discard the used battery according to the battery manufacturer's instructions.

---

## 1.2 Warranty and Service

Cadex Electronics Inc. warrants your C8000 Battery Testing Unit against defective materials and workmanship for a period of two (2) years from the original purchase date.

The warranty does not cover:

- Damage caused by abusive operation, negligence, accident, or improper installation.
- Damage caused by an attempted repair not authorized by Cadex.
- Cosmetic damage caused by normal wear and tear.
- Damage from external causes such as leakage spills, power fluctuations, power failures, or inadequate shipping.
- Product received without the appropriate model number, serial number, or safety markings.
- Products used for rental purposes.

---

### 1.2.1 Warranty Service

Before sending the unit for service, contact Cadex Technical Support. If your product requires warranty service, the representative will provide a Material Return Authorization Form or Material Return Authorization (MRA) and the location of the nearest service center.

- Ship the product to the service center with freight, insurance, and customs duties prepaid. The MRA must be included to obtain warranty service.
- Ensure that each unit is properly packed before shipping, preferably in the original Cadex boxes. Damage caused in transit due to improperly packed items is not covered under warranty.
- Products returned from warranty service are shipped with freight prepaid by Cadex.

## 1.2.2 Non Warranty Repairs

Before sending the unit in for service, contact Cadex Technical Support at 1-800-565-5228 or 1-604-231-7777. If your product is not covered by warranty, the representative will provide the contact information for the nearest service center. You may contact the service center directly to arrange to send the product in for service. A Return Authorization form or number will be provided only if the product is returning to the Cadex Head Office.

- Ship the product to the service center with freight, insurance, and customs duties prepaid.
- Ensure that the unit(s) is properly packaged before shipping.

Cadex Electronics Inc. and Cadex authorized service centers require a Purchase Order or written authorization to precede with repairs.

---

## 1.3 Back Up and Restore Calibration Data

It is possible to manually back up the calibration data for each C8000 using the **System Update** window. This calibration data includes the settings used on the unit, such as the IP address and mask. Back up of the calibration data from the PC to removable media (writeable CD, DVD, or magnetic tape) is recommended.

---

### 1.3.1 Back Up Calibration Data

If required, following the instructions below can perform a manual backup of the calibration data. **Note:** By default the calibration data is stored in the following location; *C:\Documents and Settings\All Users\Application Data\Cadex Batlab\DB\Calibration*

1. From the **Tools** menu, click **System Update**.
2. Select the check box for each C8000 to back up calibration data for.
3. Under the **Calibration** tab, click **Backup Calibration Data**.
4. Click **OK**.

---

### 1.3.2 Restore Calibration Data

BatteryLab copies (restores) backed up calibration data from the database.

To restore calibration data:

1. From the **Tools** menu, click **System Update**.
2. Select the check box for each C8000 to restore calibration data for.
3. Under the **Calibration** tab, click **Restore Calibration Data** to restore previously backed up data.
4. Click **OK**.



### **Important**

Each new C8000 has been calibrated at the factory, and has its factory calibration data stored on the C8000. This calibration data is essential to providing accurate testing of batteries.

On receipt of each new C8000, configure the unit with a static IP address, the network mask address, and the PC Host IP address. Then run BatteryLab and configure BatteryLab to allow connection from the new C8000. Choose **Connect** to allow BatteryLab to automatically backup the calibration data for the new C8000.

This calibration data is essential to providing accurate testing of batteries. After installing and configuring Cadex BatteryLab to communicate with the C8000, use BatteryLab to back up the calibration data to the computer.

Each new C8000 should be connected to the PC for BatteryLab to automatically back up the calibration data.

If, for any reason, the calibration data on the C8000 gets corrupted, the calibration data can be restored from the backup copy. Otherwise, the C8000 must be shipped to a Cadex Service Centre for re-calibration. The shipping and service cost is not covered by the warranty.

# 2 Battery Tester

---

## 2.1 Getting Started with the Battery Tester

---

### 2.1.1 The C8000 Battery Tester User Manual

Welcome to the *Cadex C8000 Battery Tester User Manual*. This manual provides instructions to configure the C8000 and to test batteries. Up to four batteries can be tested at any time using one of several testing programs.

#### 2.1.1.1 Topics You Need to Know

To properly use the C8000, review the following sections of this manual:

- Cautions and Warnings
- Configure the C8000
- Test Batteries
- View Test Results



**Caution!**

The C8000 has been calibrated at the factory and has its factory calibration data stored on it. The calibration data is automatically backed up to a file in the \Batlab\DB folder (or the folder indicated in the **About** window) when a C8000 connects to Cadex BatteryLab.

If for any reason, the calibration data on the C8000 gets corrupted, restore the calibration data from the backup copy provided by Cadex Electronics.

For more information, see [1.3 Back Up and Restore Calibration Data](#).

---

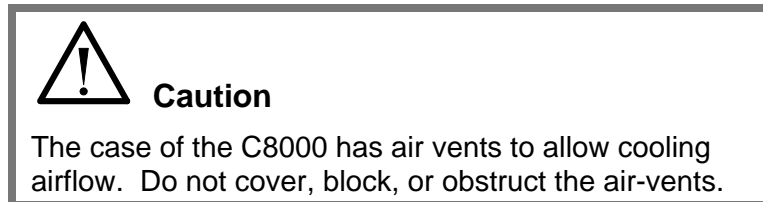
## 2.1.2 What is in the Box

The C8000 box contains:

- (1) C8000 Battery Testing System (Part #11-308-0000)
- (4) 1.8m (6') Power port cables (for battery ports)
  - Power Port Cable (Part #17-670-0058)
    - Alligator Clips:
      - Part #62-634-0002 (Red 2mm)
      - Part #62-634-0003 (Black 2mm)
      - Part #62-634-0010 (Red 4.4mm)
      - Part #62-634-0011 (Black 4.4mm)
- Specifications:
  - Voltage: 0~48V
  - Current: 0~10A
  - *Wattage:* 0~100W
- (4) 1.8m (6') Auxiliary data cables (for I/O ports) (Part#17-670-0059)
- (1) C8000 DUAL POWER PORT CABLE (Part# 17-070-1008)
  - Specifications:
    - Voltage: 0~48V
    - Current: 0~20A
    - *Wattage:* 0~200W

- (3) Power cords
  - (1) North American power cord (Part #68-723-1815)
  - (1) British power cord (Part #68-723-1806)
  - (1) European power cord (Part #68-723-1805)
- (1) 3m (10') Ethernet cable
  - (The supplied Ethernet cable is only required for communication between BatteryLab and the C8000.) (Part #68-931-0010)
- (1) BatteryLab PC software on CD-ROM (Part #84-100-0010)
- (1) C8000 Rack Mounting Bracket Set
  - (For 19" 3U mounting type rack)
  - (2) Mounting Brackets (Part #79-320-0034)
  - (6) Screws (Part #75-108-2204)
  - (6) Washers (Part #75-408-2204)

Before configuring the C8000 Battery Tester, become familiar with the Front Panel, Back Panel and Components of the Battery Adapter sections of this manual. When ready, see section [2.6 Configure the C8000](#) to continue.



---

## 2.1.3 Optional C8000 Accessories

### 2.1.3.1 C8000 Adapter Unit

Desktop converter unit that provides cross platform compatibility with SnapLock™ and RigidArm™ Battery Adapters (4-wire version only). Battery applications include Cellular phones, 2-way radios and other custom applications.

Specifications:

Supports all RigidArm and SnapLock 4-wire series adapters.



### 2.1.3.2 RigidArm™ Universal Battery Adapter

RigidArm™ allows for easy connection to cellular batteries of any size. Spring-loaded arms lock in position to allow quick and accurate setup for repetitive testing. A retractable floor holds batteries vertically or horizontally; adjustable magnetic battery guides are included. *Requires C8000 Adapter Unit.*

Specifications:

Voltage: 18V

Current: 3A

### 2.1.3.3 SnapLock™ Universal Battery Adapter (4-wire versions only)

SnapLock™ gives a precise connection to the battery allowing for easy hook up. The adapter contains C-Codes that can be used to configure the C8000 and other Cadex platforms to the correct setting. Specialty adapters available on request. *Requires C8000 Adapter Unit.*

Specifications:

Voltage: 18V

Current: 3A

### 2.1.3.4 Load Capture Unit (LCU)

LCU captures and stores load signatures (in BatteryLab) of any device up to 100A in real-time. Capture a power tool load signature (or any other electronic device) by drilling through a steel beam. Then apply a repeatable load signature to any battery to determine; performance characteristics, battery life, time of use, etc. Other applications for the LCU include spinning up a hard drive on a laptop or accelerating an electric motor.

Specifications:

Buss-bar Current:

- 0-10A (2% of Full Scale, Ripple: 20mA)
- 0-100A (2% of Full Scale, Ripple: 50mA)

External Current Clamp:

- 0-400A (1% of Full Scale, Ripple: 500mA)

Voltage Input Terminals:

- 500mV~48V (2% of Scale, Ripple: 20mV)

Capture Frequency:

- DC to 250Hz

Thermal Couple:

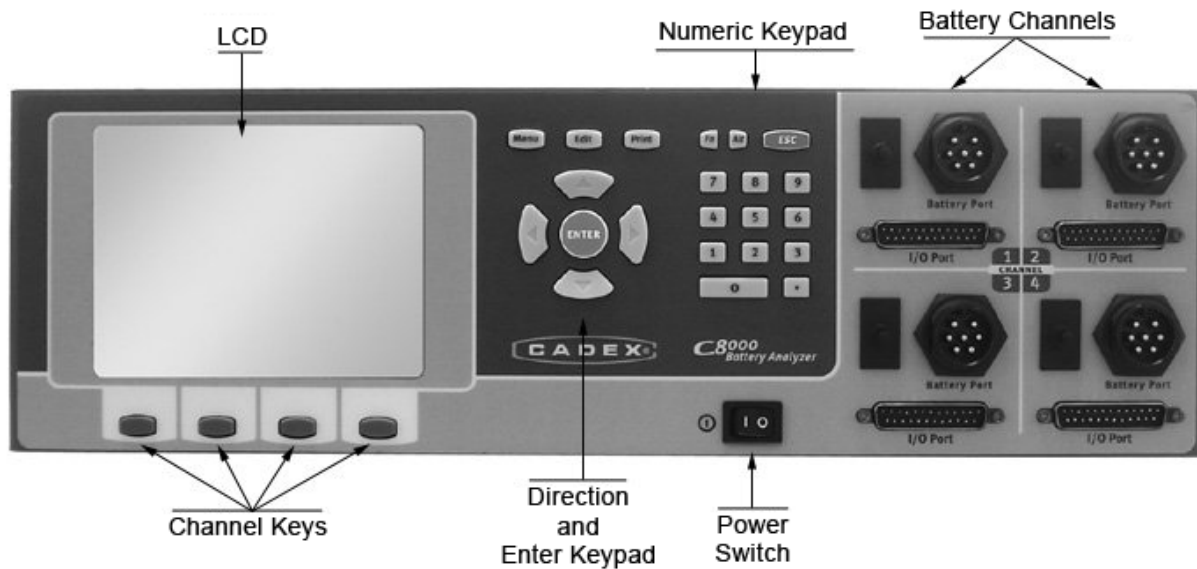
- Supports K-type –
  - ±2°C plus Thermal Couple accuracy

---

## 2.2 Display and Controls

---

### 2.2.1 Front Panel




#### 2.2.1.1 LCD Settings

The LCD screen displays the fields that you need to fill in prior to executing a test and also displays test status and results. Use the keypad and arrow buttons to enter information into the fields on the screen.

#### 2.2.1.2 Channel Key Buttons

There are four channel key buttons below the LCD screen. The functions of these buttons vary depending on the window displayed on the LCD. The function (if any) of each button is displayed on the screen, just above the button.

### 2.2.1.3 Arrow and ENTER Buttons


	<p>Use the <b>arrow</b> buttons to move from field to field.</p> <p>Use the <b>ENTER</b> button to accept the information entered into the fields</p>
---	---

**Note:** The **Menu** and **Print** buttons are not used. The **Edit** button activates the onscreen keypad when an editable field is selected on the C8000.

### 2.2.1.4 Navigating the LCD Display

- Use the ◀, and ▶ arrow keys to move from one field to another.
- Press the **Edit** key to activate the selected remark field for edits.
- Use the ◀ and ▶ keys to scroll through the alphabet. Press **ENTER** to select the letter.
- Use the numeric keypad to enter numbers in the selected field.
- Press **ENTER** to save the data you have entered in the field and move to the next field.
- Press **OK** to save the data you entered in the screen.

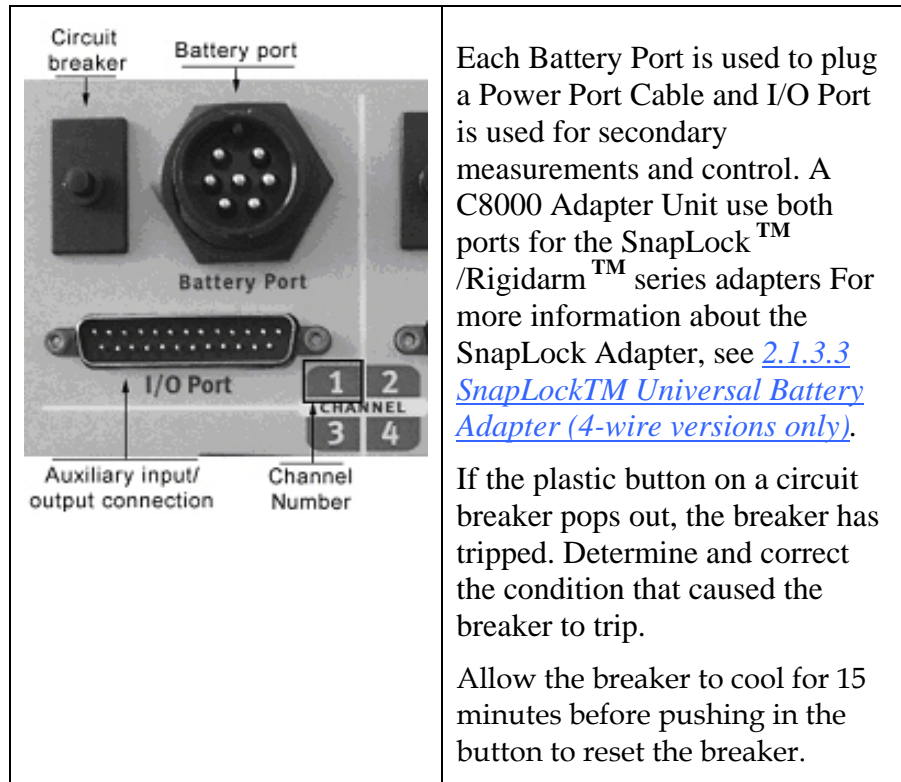
### 2.2.1.5 Numeric Keypad

	<p>Use the Numeric Keypad to enter numbers in the selected field.</p> <p>To exit from a field without saving changes, press the <b>ESC</b> key.</p>
---	---

### 2.2.1.6 Battery Port Connections

There are four port connections, to attach up to four battery adapters.

Each channel has a battery port, an auxiliary input/output, and a circuit breaker.

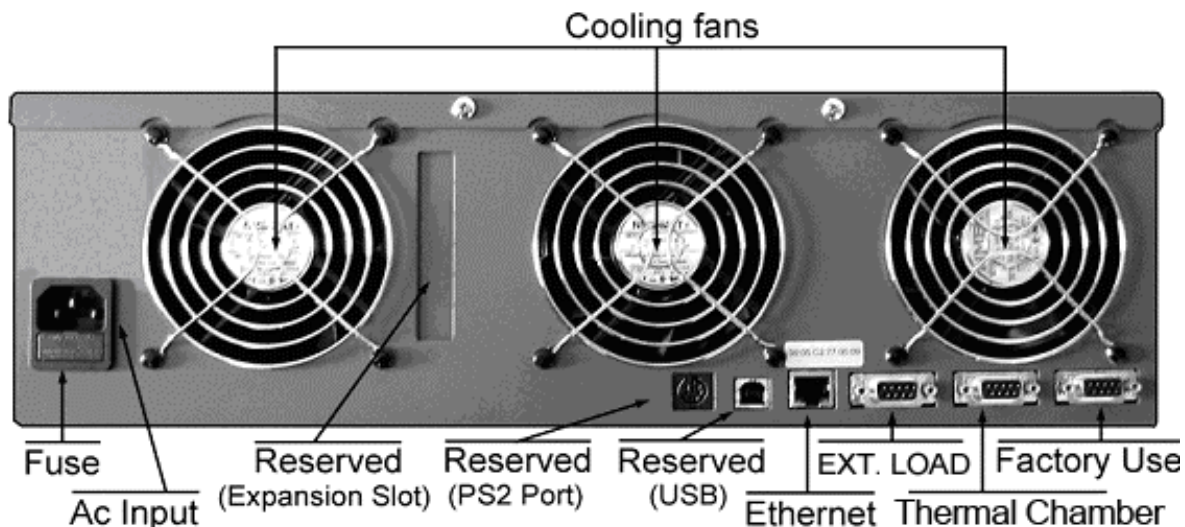


A battery adapter may not always be available.

In most cases, the channel cable will terminate with positive/negative wires and have a magnetic temperature probe to attach to the battery.

If the breaker button does not stay in when you push it, allow more time for the breaker to cool. (The breaker does not automatically reset.)

## 2.2.2 Back Panel



### 2.2.2.1 AC Input

The AC Input connects the C8000 to an AC electrical power source with the provided power cord. The power entry uses standard IEC320 socket on the back panel. A fuse protects the C8000 from AC overload.

### 2.2.2.2 Ethernet Port

The Ethernet port is used to connect the C8000 to the network or the host computer. The Ethernet Port (on the back panel) has two LEDs to indicate communication between the C8000 and a computer.

Use this port with the **TCP/IP Settings** menu. For more information, see [3.1.8.5 TCP/IP Settings](#).

### 2.2.2.3 Serial Ports and USB Port

The first Serial Port (DB9 Female I/O sockets) on the C8000 is reserved. The intended uses of the remaining Serial Ports are for Cadex-approved External Loads (Serial Port 2) and Thermal Chamber (Serial Port 3) controls.

#### Pinout Serial Ports (2) and (3)

- 1 - Not Used
- 2 - RX (Receive signal)
- 3- TX (Transmit signal)

4 - DTR (Digital Terminal Ready) 5V

5 - GND (Ground)

6 - Not Used

7 - RTS (Request To Send)

8 - CTS (Clear To Send)

9 - Not Used

USB functionality is not enabled.

#### 2.2.2.4 Cooling Fans

The thermostatically controlled fans operate automatically to keep the inside of the C8000 at optimum temperature. Keep all case vents and fan openings clear to ensure free airflow through the C8000.

---

## 2.3 Cadex C8000 Adapter Unit



---

### 2.3.1 Cadex C8000 Adapter Unit

The Cadex C8000 Adapter Unit allows C7x00 adapter to be used with the C8000.



### **2.3.2 Connect the C8000 Adapter Unit to the C8000.**

1. Align the notch on the battery connector cable plug with the notch on the battery connector and push in the cable.
2. Push the battery connector plug in while turning the ring on the battery connector clockwise until the lock is engaged.

See [2.4.2 Connect the Power Port Cable to the C8000](#) for instructions on how to connect the Power Port Cable.

3. Push the DB25 female connector in to corresponding Auxiliary connector of the C8000 channel and tighten the connector hand screws.

To remove the battery connector cable from the C8000, turn the ring on the connector plug counter-clockwise and then pull the cable plug out of the connector.

---

## 2.4 Cables

---

### 2.4.1 Power Port Cable

The Power Port Cable conducts electric power between a connected battery and the C8000. The Power Port Cable is used only for power transfer, voltage measurement and temperature reads - all other functions operate via the Auxiliary Input/Output (I/O) cable.

To achieve better accuracy, the C8000 utilizes a four-wire design, where the two main wires provide a path for charge and discharge currents while the other two paths measure the voltage as close to the battery as possible.

---

### 2.4.2 Connect the Power Port Cable to the C8000

- a. To connect a Power port cable or Dual power port cable.
  - i. On the C8000 front panel, choose your desired battery channel.

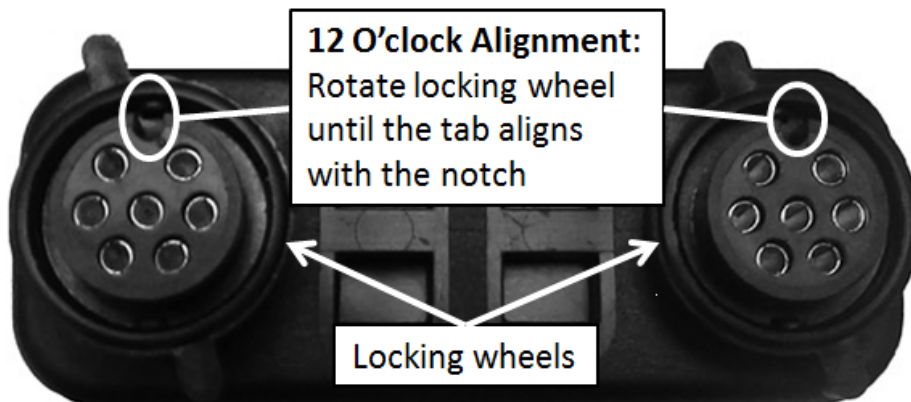
Note: The Dual power port cable can be connected to channels 1 & 2 and/or 3 & 4.

- ii. Align the notch with the tab on the power port cable connector (see connector end diagrams).



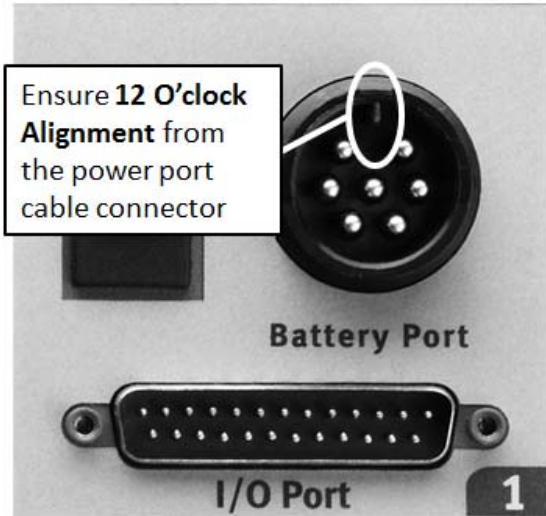


**Figure 1** – Power port cable connector end-view



**Figure 2** – Dual power port cable connector end-view

- iii. Push the battery connector plug into the desired battery channel outlet (on the C8000), then rotate the locking wheel to secure the connector to the battery channel outlet.



**Figure 3** – Channel 1 outlet (on C8000)

- iv. The Power port cable is now ready to connect to a battery.

To remove the battery connector cable from the C8000, turn the ring on the connector plug counter-clockwise and then pull the cable plug out of the connector.

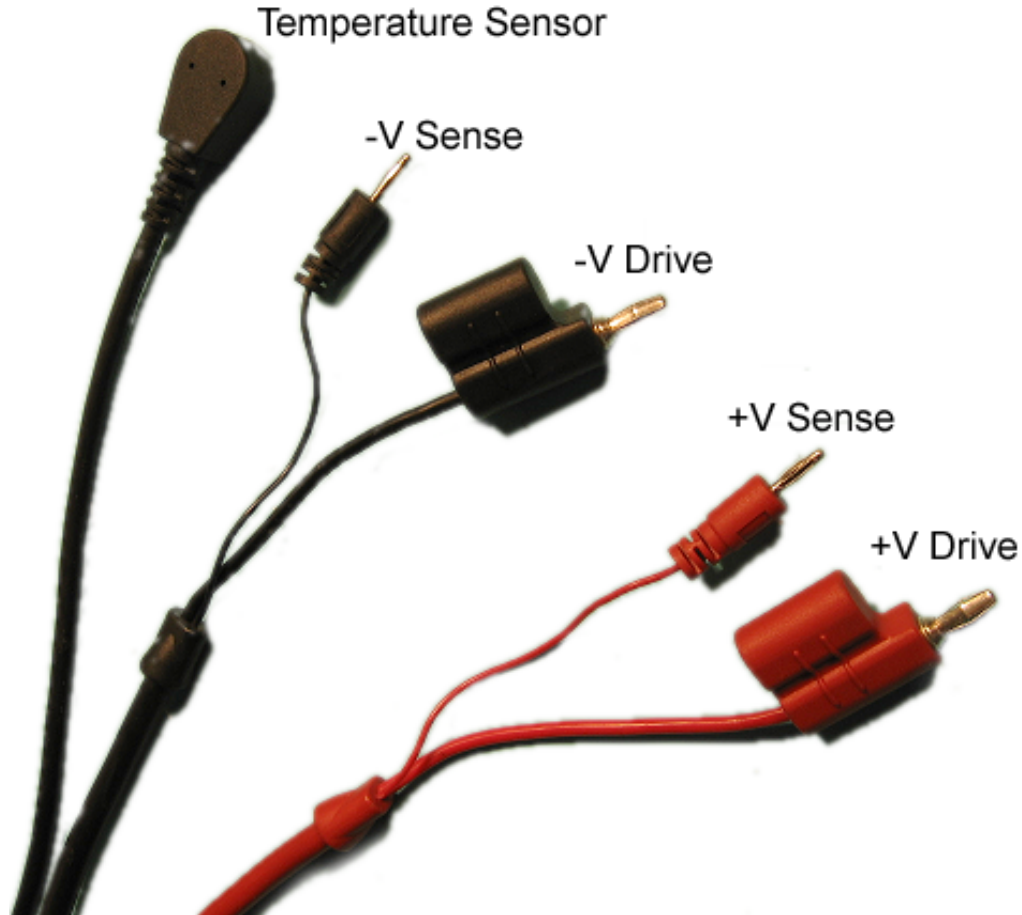
The following diagram shows how the Drive and Sense lines of the cable should be connected for normal operation.

The cable has six leads as follows:

- Two drive lines with heavy gauge wire to supply the charge and discharge current
- Two sense lines to measure the voltage on the battery terminals. **Warning:** Sense lines should be connected to the battery terminals and correctly installed - otherwise, incorrect operation may occur.

The sense plugs can be plugged into the drive plug molded body for single connection to the battery.

- Two for the magnetic temperature sensor. The magnetic temperature probe should be attached to the casing of the battery.



---

### 2.4.3 Auxiliary data cables (for I/O ports)

The Auxiliary data cables (for I/O ports) enables the C8000 to interface with third-party devices, the Cadex SnapLock/RigidArm series (when using the C8000 Adapter Unit), and SM-Bus batteries.

Custom programs can be configured to control and respond to states of the configurable lines.

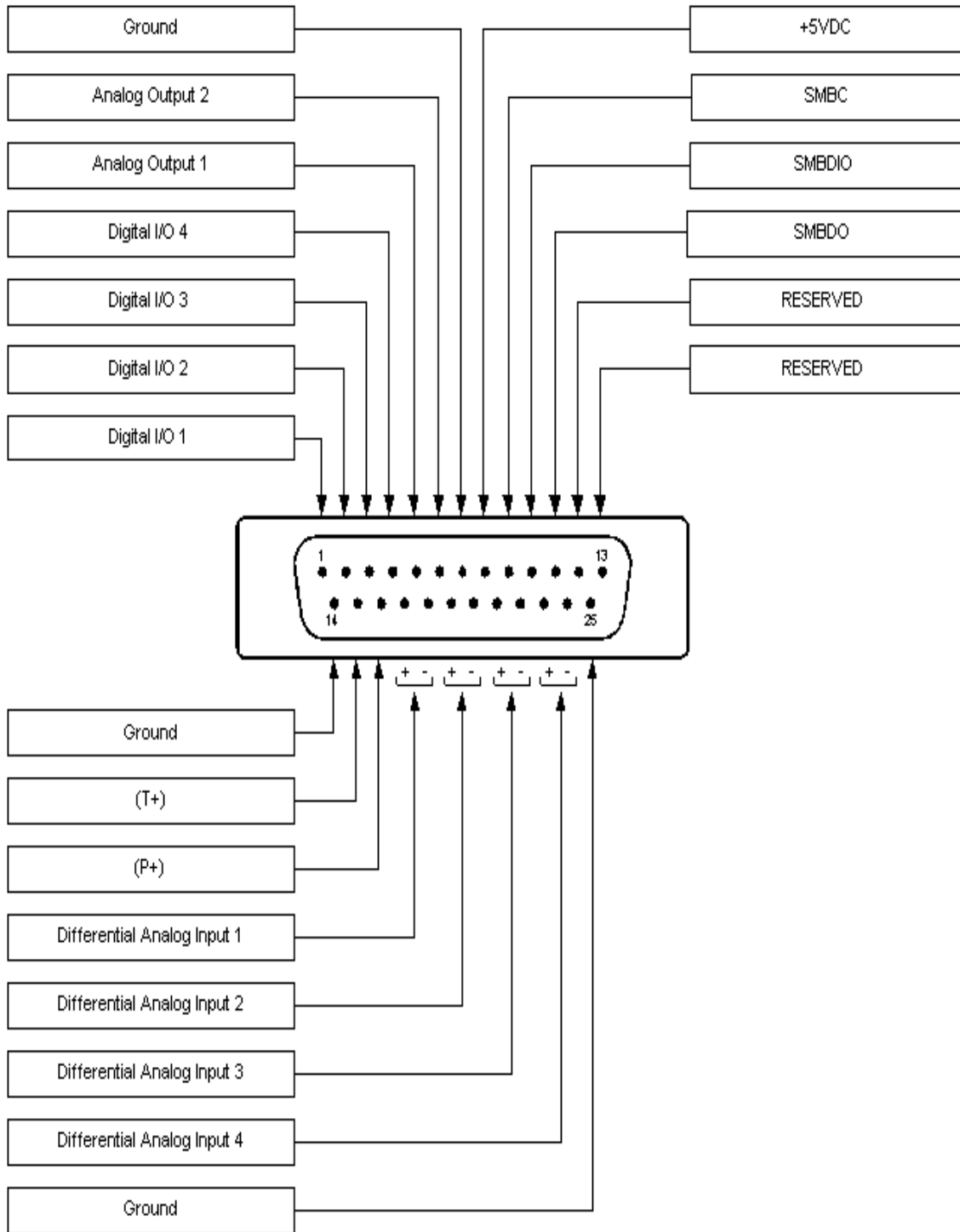
The connector provides the following interfaces:

- SM-Bus
- Four configurable Digital Inputs or Outputs (Program Configurable) (Pull-up Required)
- Two Analog outputs (Program Configurable)
- Four Differential Analog inputs with selectable ranges (Program Configurable).

Note: Once the C8000 Adapter Unit is connected, the input/output ports become reserved.

The following diagrams show the pin and electrical specifications of interfaces for the Auxiliary Input/Output Connector.

**Auxiliary data cables (for I/O ports) Pinout Diagram**



## Auxiliary data cables (for I/O ports) Wiring Chart

<i>Pin #</i>	<i>Function</i>	<i>Wire Color</i>
1	Digital I/O 1	White
2	Digital I/O 2	Yellow
3	Digital I/O 3	Orange
4	Digital I/O 4	Pink
5	Analog Out 1	Gray
6	Analog Out 2	Brown
7	Ground	Black
8	+5VDC	Red
9	SMBC	Purple/white
10	SMB D I/O	Brown/white
11	SMB DO	Black/white
12	Reserved	Yellow/black
13	Reserved	Pink/black
14	Ground	Green
15	Temperature (T+)	Blue
16	Pressure (P+)	Purple
17	Differential Analog Input 1 Positive (+)	Red/white
18	Differential Analog Input 1 Negative (-)	Red/black
19	Differential Analog Input 2 Positive (+)	Orange/white
20	Differential Analog Input 2 Negative (-)	Orange/black
21	Differential Analog Input 3 Positive (+)	Green/white
22	Differential Analog Input 3 Negative (-)	Green/black
23	Differential Analog Input 4 Positive (+)	Blue/white
24	Differential Analog Input 4 Negative (-)	Gray/black
25	Ground	Light green
Shell	Earth	Drain

## 2.5 C8000 Specifications

### 2.5.1 C8000 System Technical Specifications

<ul style="list-style-type: none"> <li>Channels</li> </ul>	4 Independent Channels each including: <ul style="list-style-type: none"> <li>1 Battery Port + 1 I/O Port</li> </ul>
<b>Physical</b>	
<ul style="list-style-type: none"> <li>Dimensions</li> </ul>	480mm x 380mm x 140mm (18.9" x 15.0" x 5.5")
<ul style="list-style-type: none"> <li>Weight</li> </ul>	15.5 kg (34 lb)
<ul style="list-style-type: none"> <li>Mounting Options</li> </ul>	Desktop or 19" (483mm) 3U Rack-mount (brackets included)
<ul style="list-style-type: none"> <li>Display</li> </ul>	5.7" (145mm) QVGA 320x240 graphics with backlight
<ul style="list-style-type: none"> <li>Battery Ports (front panel)</li> </ul>	4 Ports each including: <ul style="list-style-type: none"> <li>Battery Positive (+)</li> <li>Battery Negative (-)</li> <li>Sense Positive (+)</li> <li>Sense Negative (-)</li> <li>Thermistor Input</li> <li>Thermistor Ground</li> </ul>
<ul style="list-style-type: none"> <li>Auxillary Ports (I/O) (front panel)</li> </ul>	4 x DB25 Type each including: <ul style="list-style-type: none"> <li>4 Differential Analog Inputs: 0-5V, 0-10V, or 0-15V</li> <li>4 Digital Inputs: 0-5V</li> <li>2 General Purpose Analog Outputs: 0-5V</li> <li>SMBus Enabled: 5 Possible Termination Signals</li> </ul>
<ul style="list-style-type: none"> <li>Active Data Ports (back panel)</li> </ul>	<ul style="list-style-type: none"> <li>Ethernet 10/100MB for connection to PC</li> <li>Designated Serial Port for External Load</li> <li>Designated Serial Port for Environmental Chamber</li> </ul>
<b><u>Environment</u></b>	
<ul style="list-style-type: none"> <li>Operating Temperature</li> </ul>	5°C-35°C (40°F-95°F)
<ul style="list-style-type: none"> <li>Storage Temperature</li> </ul>	-20°C-70°C (-4°F-160°F)

<b><u>Battery Compatibility</u></b>	
<ul style="list-style-type: none"> <li>Chemistries</li> </ul>	All Standard Battery Types <ul style="list-style-type: none"> <li>Lead Acid</li> <li>Ni-based: NiMH, NiCd</li> <li>Li-based: Li-ion, Li-Phosphate</li> </ul>
<ul style="list-style-type: none"> <li>Capacity Range</li> </ul>	50mAh to 1000Ah
<b><u>Electrical</u></b>	
<ul style="list-style-type: none"> <li>Input Power</li> </ul>	<ul style="list-style-type: none"> <li>100-240 VAC</li> <li>50-60 Hz</li> </ul>
<ul style="list-style-type: none"> <li>Battery Voltage Range</li> </ul>	Nominal 1.2V-36V (max 45V) supports serial connection of: <ul style="list-style-type: none"> <li>Up to 10 Li-ion cells (3.6V/cell)</li> <li>Up to 18 Lead Acid cells (2.0V/cell)</li> <li>Up to 30 Nickel-based cells (1.2V/cell)</li> </ul>
<ul style="list-style-type: none"> <li>Maximum Charge Power</li> </ul>	100W per channel = 400W total
<ul style="list-style-type: none"> <li>Maximum Discharge Power</li> </ul>	80W per channel = 320W total <i>Dual Power Port cable may be to increase the maximum Power Rate to 160W per channel pair</i> <i>External Load may be used to increase Discharge Rate up to 2400W</i>
<ul style="list-style-type: none"> <li>Maximum Charge/Discharge Current</li> </ul>	30mA to 10A set in 1mA increments <i>Dual Power Port cable may be to increase the maximum Discharge Rate to 20A per channel pair</i> <i>External Load may be used to increase Discharge Rate up to 240A</i>
<ul style="list-style-type: none"> <li>Output Frequency</li> </ul>	Square 2 kHz (500 microseconds)
<ul style="list-style-type: none"> <li>C8000 Accuracy</li> </ul>	<ul style="list-style-type: none"> <li>Voltage = 0.1% full scale</li> <li>Current = 0.25% full scale</li> </ul>
<b><u>Other Specifications</u></b>	
<ul style="list-style-type: none"> <li>Power Management</li> </ul>	Current automatically scaled down if power limits are exceeded – message indicates scaled test
<ul style="list-style-type: none"> <li>Charge Methods</li> </ul>	Charge methods are dependent upon chemistry: <ul style="list-style-type: none"> <li>Li-ion + Lead Acid = constant current/</li> </ul>

	constant voltage
• Discharge Methods	<ul style="list-style-type: none"> <li>• Nickel-based = constant current (DC charge) with optional Reverse Load Charge method</li> </ul>
	<ul style="list-style-type: none"> <li>• Constant current</li> <li>• Constant power</li> </ul>
<b><u>Data Acquisition</u></b>	
• System Sample Rate	500 microseconds
• Termination Data (last 500 samples) Capture Rate	2~200 milliseconds
• Capture/Display Rate (non-termination)	1~60 seconds
<b><u>Certification</u></b>	
• Safety	CSA, UL, CE
• Environmental	RoHS, WEEE

## 2.5.2 Auxillary Port Absolute Maximum Ratings

When using the Auxiliary Input/Output Connector, the voltage settings for the pins must not exceed the absolute maximum ratings - otherwise the C8000 may become damaged. The absolute maximum ratings for the Auxiliary Input/Output Connector are as follows:

<i>Voltage Setting</i>	<i>Maximum Rating</i>
Voltage at Digital I/O 1-4:	-0.1 to +6V
Voltage at SMBC, SMBD or SMBDIO:	-0.1 to +5.5V
Voltage at Analog Output 1-2:	-0.1 to +6V
Voltage at T+ or P+:	-0.1 to +5V
Voltage at Differential Analog Input 1-4 (either input, relative to ground):	-50 to +50V
Voltage at Differential Analog	±50V



Input 1-4 (differential):	
Current at Digital I/O 1-3:	-20mA (open collector / sinking only)
Current at Digital I/O 4:	-100mA (open collector / sinking only)
Current at Analog Out 1-2:	±5mA
Current at +5VDC:	+100mA

### 2.5.3 Auxillary Port Operating Ratings

When using the Auxiliary Input/Output Connector, the operating ratings must be set according to the following settings:

<i>Voltage Setting</i>	<i>Operating Rating</i>
Voltage at Digital I/O 1-4:	0 to +5V (A Pull-up is required) <b>(open collector)</b>
Voltage at SMBC, SMBD or SMBDIO:	0 to +5V
Voltage at Analog Output 1-2:	0 to +5V (±1mA)
Voltage at T+ or P+:	0 to +3.3V
Voltage at Differential Analog Input 1-4 (either input, relative to ground):	0 to +48V
Voltage at Differential Analog Input 1-4 (differential, + relative to -):	0 to +15.5V
Impedance of Analog Input + to -	~1.1MΩ
Impedance of Analog Input + to gnd	~100kΩ
Impedance of Analog Input - to gnd	~1MΩ

## 2.6 Configure the C8000

---

### 2.6.1 Set Up the C8000

To set up and configure the C8000 perform the following steps:

1. Plug in the power cord and ensure the battery adapter cords are properly connected to the C8000.
2. Switch ON the C8000 set the clock and enters user information. For instructions, see [2.12.1 Set the Clock](#) and [2.12.2 User Information](#).
3. If required, use **LCD Settings** to adjust the contrast of the LCD display. See [2.12.3 LCD Settings](#) for more information.

---

## 2.7 User Maintenance for the C8000

---

### 2.7.1 User Maintenance Warnings



#### **Warning**

There are no internal user-serviceable parts in the C8000 other than the internal backup battery.

Except for changing the battery, unauthorized disassembly and/or repair of the C8000 by anyone other than an authorized Cadex Service Center may cause a risk of injury or death and will void the warranty.

For more information, see [1.1 Cautions and Warnings](#).

## 2.7.2 Clean the C8000



### Caution

Before cleaning, turn off the power and unplug the AC power cord.

Do not allow any liquids to enter the case under any circumstances.

Clean the C8000 only with a damp cloth moistened with mild soap and water. Allow to thoroughly dry.

For more information, see [1.1 Cautions and Warnings](#).

## 2.7.3 Replace the Fuse

If the C8000 does not power up, make sure that the power cord is properly inserted and that power is available.

If the C8000 still does not power up, the main (AC input) fuse may need to be replaced.

Replace fuses only with fuses of the same type and rating:  
Fuse 5x20mm T8A 250V, Cadex part number 52-546-0800.



### Caution

Before replacing the fuse, unplug the power cord and allow the C8000 to cool for at least one minute.

The C8000 contains **capacitors** that could retain a charge after the AC power is disconnected.

For more information, see [1.1 Cautions and Warnings](#).

To replace the main fuse:

1. Remove all batteries and adapters, turn off the C8000, and unplug the power cord from the AC Input.



**Wait at least one minute before continuing.**

2. Using a flathead screwdriver, position the screwdriver at the top of the fuse cover (beneath the AC Input) and pry open the fuse cover.
3. Carefully pull out the fuse.

4. If the filament inside the glass tube is broken, replace the fuse. Be aware that the filament can sometimes appear intact even when it is broken.
5. With the fuse inserted, push the fuse cover back into place.
6. Connect the power cord and turn ON the C8000.

## 2.7.4 Replace the Backup Battery



### Caution!

Test results may be lost when the backup battery is removed. Backup the calibration data to the PC hard disk. Retrieve test results stored on the C8000 to the BatteryLab database. To download the test results to BatteryLab, select *Retrieve Results* from the **File** menu on the **Test Results** window. For more information, see [3.6 View Test Results in BatteryLab](#).

The C8000 uses a 3-volt lithium coin battery (type CR2032 or equivalent, Cadex part number 45-206-0001) to preserve settings while the C8000 is turned OFF. With normal use of the C8000, you will seldom need to replace the backup battery.



You will need the following items to replace the battery:

- A #2 Phillips screwdriver.
- A new 3-volt lithium battery.
- A wrist strap or other device to eliminate electrostatic discharge.



**Caution! Electrostatic Sensitive Device**

Do not open the C8000 or touch any part of its internal components if you are not grounded.

Do not attempt to open the C8000 while it is plugged into an electrical outlet or any peripheral device. Severe electrical shock to the operator and/or damage to the C8000 could result!

For more information, see [1.1 Cautions and Warnings](#).

To replace the backup battery in the C8000:

1. Remove all batteries and adapters, turn off the C8000 and unplug the power cord and I/O port cords.

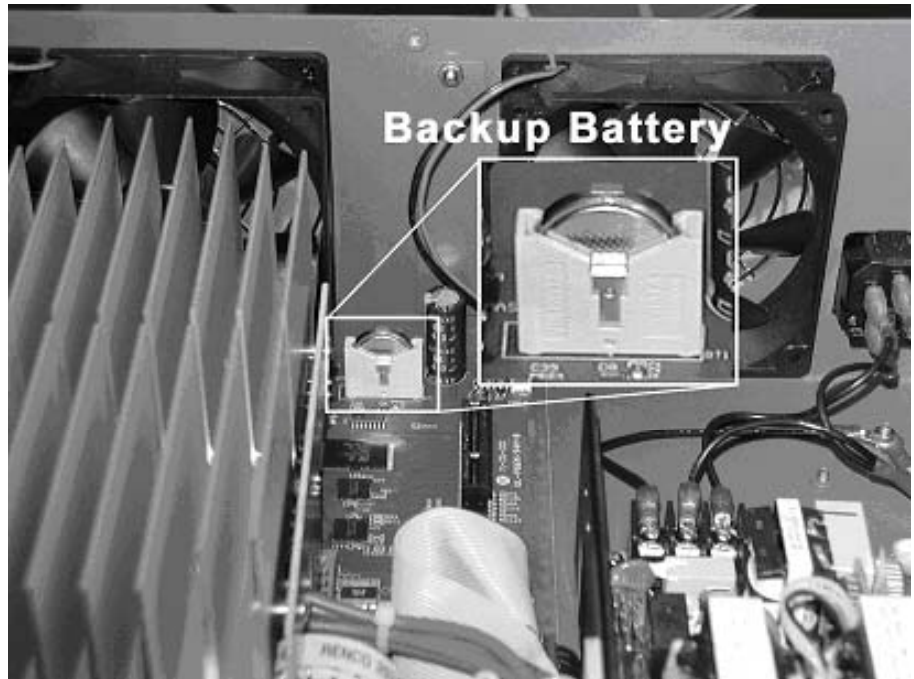


**Wait at least one minute before continuing. Do not attempt to open the C8000 while it is plugged into an electrical outlet or any peripheral device. Severe electrical shock to the service person and/or damage to the C8000 could result!**

2. Use a Phillips screwdriver to remove the following screws:
  - Two screws on the right side.
  - Two screws on the back panel.
  - Two screws on the left side.
  - One screw on the top.
3. Remove the top cover by sliding it back slightly and then lifting. The backup battery is located at the back of the C8000, in front of the expansion slot and between two fans.
4. Move the upper clip of the battery holder out of the way.
5. Using your fingers or insulated pliers or tweezers, gently pull the old battery out of the holder. Be very careful not to damage the battery.



**Do not use pliers or tweezers with bare metal tips. They will short the battery and could cause it to explode.**



**Ensure correct battery polarity.**

Insert the new battery in the holder, with the positive terminal facing toward the fan until the clip slips in place.

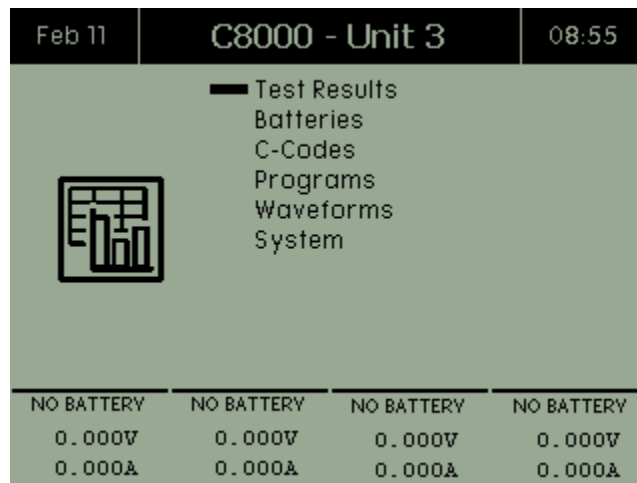
1. Replace the cover, making sure that no interior wires or cables are caught or pinched between the cover and the C8000 case.
2. Replace the seven cover screws.
3. Plug in the power cord and cables.
4. Turn ON the C8000. The settings may have returned to factory defaults, in which case you will need to reprogram settings.

## 2.8 The Battery Tester Application

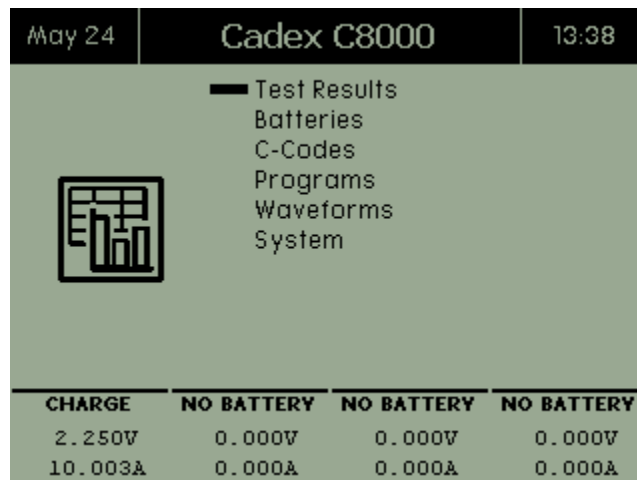
Customizing features not available in standalone:

1. Waveform creation (Waveform revision information only)
2. Custom Programs (Version/Comment/ "I/O" port configuration only) List feature only.
3. No Graphing or Detail information for Test Results. (Summary of information only).
4. No Load Capture capabilities.

When you power on the C8000 without any batteries connected, the **Main** screen appears: When connected to BatteryLab, the C8000 displays the Unit # that corresponds to BatteryLab's windows.



The **Main** screen displays six menu items: [2.8.2 Test Results](#), [2.8.3 Battery Profiles](#), [2.9 C-Codes](#), [2.10 Programs](#), [2.11 Waveforms](#), and [2.12 Specify System Options](#).



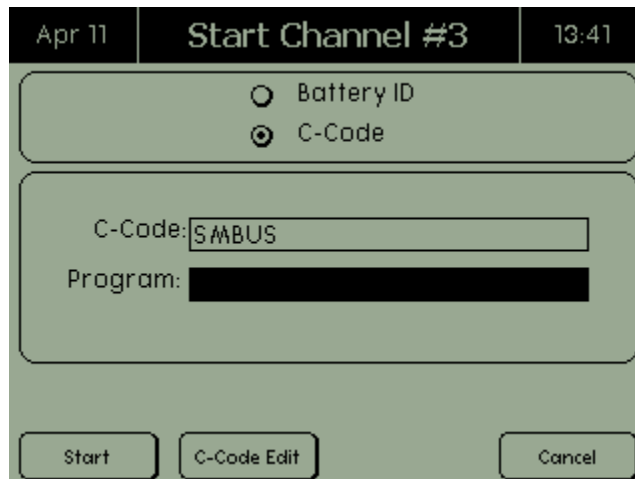
The date appears in the top left corner of the Main screen while the time appears in the top right corner. When the caption says *C8000 – Unit 3*, it means the C8000 is connected to BatteryLab. If the caption says *Cadex C8000*, it means the C8000 is in standalone mode. The bottom portion of the **Main** screen shows the channel status on the first line and the channel voltages on the second line.

## 2.8.1 Execute a Program on a Battery

### 2.8.1.1 Execute a Program without BatteryLab

To execute a program (test) on a battery in standalone mode without using BatteryLab:

1. Connect the battery.
2. Select a battery ID or C-Code from the **StartUp** screen.  
**Note:** If the **StartUp** screen is minimized, the channel status indicates “Startup”. Press the **Channel** button to maximize the screen.



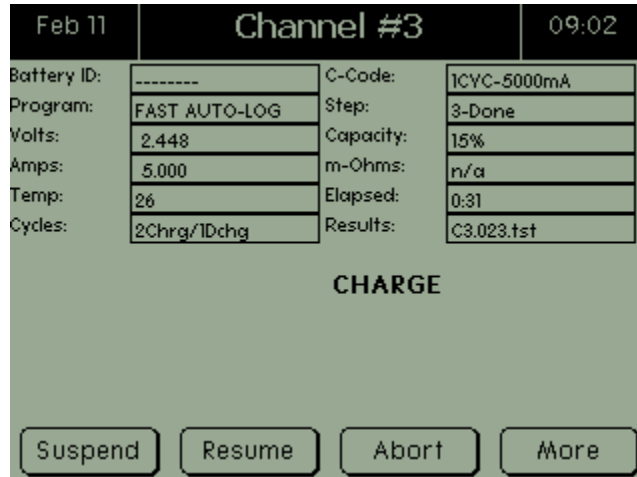
3. Select a program from the list of available programs on the C8000. The list of available programs includes all Default programs and any custom programs that have been transferred to the C8000.
4. The test starts.

If a test is currently running, press the corresponding **Channel** button to view current status on the **Channel** screen. The **Channel** screen displays the status of this channel. From the **Channel** screen you can [suspend a program](#) (2.8.1.2), [resume a suspended program](#) (2.8.1.2), [abort a program](#) (2.8.1.3), [jump to another step in a multi-step program](#) (2.8.1.5), and view auxiliary input and



output port information (2.8.1.4)

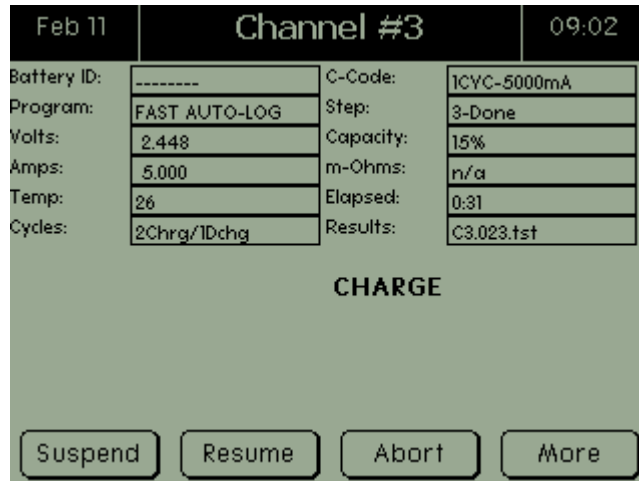
The following table describes the fields shown in the Channel screen.



<i>Field</i>	<i>Description</i>
Battery ID	The battery's identification. This field is blank if a Battery ID has not been added to BatteryLab.
Program	The name of the program that is being run.
Cycles	Indicates the number of charge and discharge cycles that have been run during any given program.
Test Results	Indicates the file name to which the current program's results will be saved to, during operation. On completion of a program, indicates the file to which the results have been saved. Note: BatLab will generate an independent TEST ID and will incorporate the data from the C8000 test result file.)
C-Code	The battery parameters being applied by the C8000.
Step	The step number for the action currently executing within the program.
Volts	Voltage across the battery terminals. The current Voltage across battery sense terminal lines. (Screen is updated once per second.)
Amps	Charge or discharge current. (Screen is

	updated once per second.)
Temp	Displays the current temperature at all times. If a thermistor is not attached, displays <i>N/A</i> . (Screen is updated once per second.)
Capacity	A percentage value showing the battery's latest measured capacity. (Note: Only after a Discharge Cycle has been run); otherwise this displays <i>N/A</i> .
M-Ohms	The resistance of the battery measured in milliohms. Displays the latest resistance measurement otherwise <i>N/A</i> when resistance measurement is not selected.
Elapsed	The time since starting the program on this battery. Test times vary depending on the program chosen and the condition of the battery.

1. From the **Main** screen, press the **Channel** button for the C8000 to test. The **Channel** screen appears.




2. The **Channel** screen shows the status of this channel, providing a test is currently running.
3. To view additional information, press **MORE**. A second **Channel** screen appears.

Mar 31	Channel #3		15:09
Battery ID:		C-Code:	1-SLA
Program:	Auto	Step:	1-Charge
Volts:	2.400	Capacity:	n/a
Amps:	6.356	m-Ohms:	n/a
Temp:	24	Elapsed:	0:01
Cycles:	1Chrg/0Dchg	Results:	C3.016.tst
<b>CHARGE</b>			
		AuxPorts	Back

### 2.8.1.2 Suspend and Resume a Running Program

While a program is running, it can be temporarily suspended. Later, the program can be resumed.

1. From the **Channel** screen, click **Suspend**. The program is immediately interrupted.

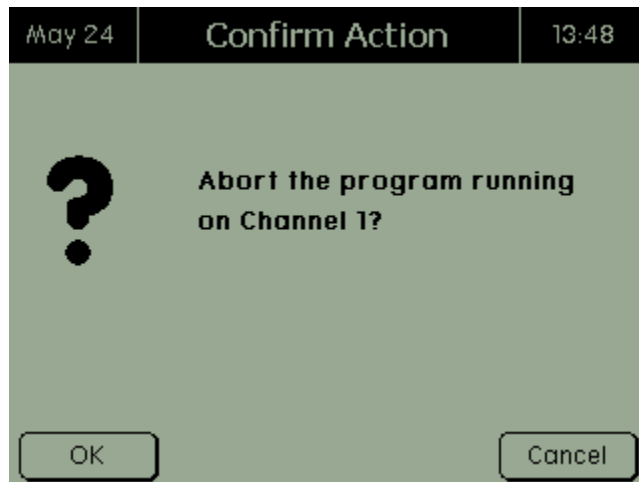
Mar 31	Channel #3		15:22
Battery ID:		C-Code:	1-SLA
Program:	Auto	Step:	1-Charge
Volts:	2.045	Capacity:	n/a
Amps:	0.000	m-Ohms:	n/a
Temp:	24	Elapsed:	0:00
Cycles:	0Chrg/0Dchg	Results:	C3.019.tst
<b>SUSPENDED</b>			
 The operation is suspended			
Suspend		Resume	
Abort		More	

2. Press **Resume** to restart the program.

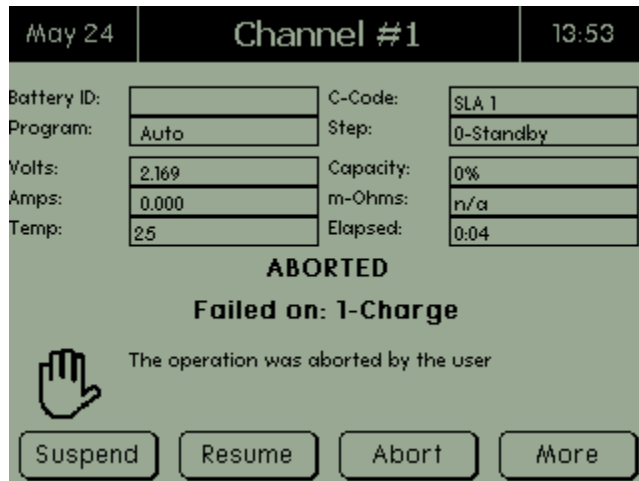
### 2.8.1.3 Abort a Running Program

To terminate a running program:

1. From the **Channel** screen, press **ABORT**. The **Confirm Action** screen appears.



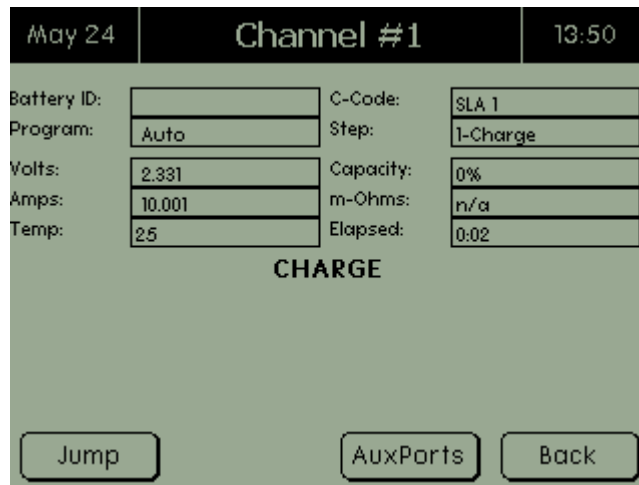
2. Press **OK**. The **Aborted** screen appears.



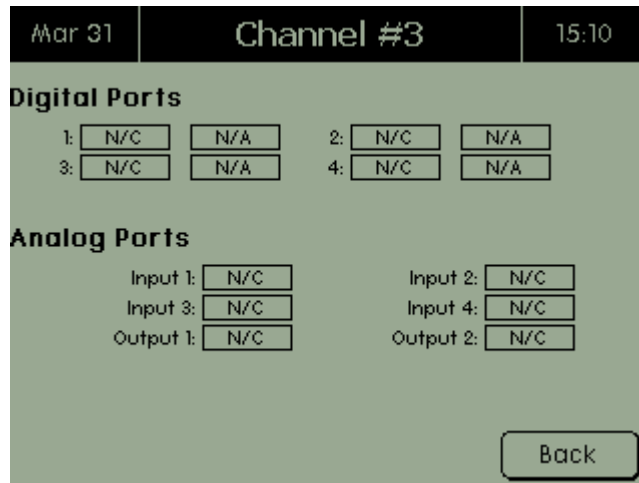
#### 2.8.1.4 View Auxiliary Port Information

While a program is active, the current program configuration can be viewed.

1. From the **Channel** screen, press **MORE**. A second **Channel** screen appears.



2. Press **AuxPorts**. The **Auxiliary Ports** screen appears.



3. Press **BACK** twice to return to the **Channel** screen.

### 2.8.1.5 Jump to a Specific Program Step

A program may contain one or more action steps. The "JUMP" command allows the ability to move immediately from the current action step to any of the other action steps, within the active program - for example, Charge, Discharge, Rest, and so on. The *Jump* function moves to a specific step in the program.

1. From the **Channel** screen, press **MORE**. A second **Channel** screen appears.

May 24	Channel #1		13:50
Battery ID:		C-Code:	SLA 1
Program:	Auto	Step:	1-Charge
Volts:	2.331	Capacity:	0%
Amps:	10.001	m-Ohms:	n/a
Temp:	25	Elapsed:	0:02
<b>CHARGE</b>			
Jump		AuxPorts	
Back			

2. Press **JUMP**. The **Jump** screen appears.

May 24	Channel #1		13:51
<b>Program: Auto</b>			
Current Step:	1	Charge	
Jump To:	1	Charge	
Use 'UP' and 'DOWN' keys to select			
OK		Cancel	

3. The *Current Step* field shows the current step that the program is in. Enter the step number to move to in the *Jump To* field and press **OK**. The C8000 will resume program operation at the selected step.

### 2.8.1.6 View SM-Bus Information

Before using any SM-Bus battery functions, ensure the SM-Bus lines from the I/O port are connected to the battery. Note: The temperature reading for SM-Bus batteries will still use the Cadex thermistor that is attached to the Power Port Cable.

All SM-Bus c-codes, both factory and custom, will contain only the actions to be executed, when the status/alarm bit is received.

A factory SM-Bus c-code is available with the following parameters. (Note: To change any of the status/alarm bit actions, create a new SM-Bus code.)

A	Fully Charged	Finished
B	Terminate Charge Alarm	Finished
C	Overcharged Alarm	Finished
D	Fully Discharged	Finished
E	Terminate Discharge Alarm	Finished
F	Over-Temperature Alarm	Two retries

The following are definitions for available actions on the status/alarm bits:

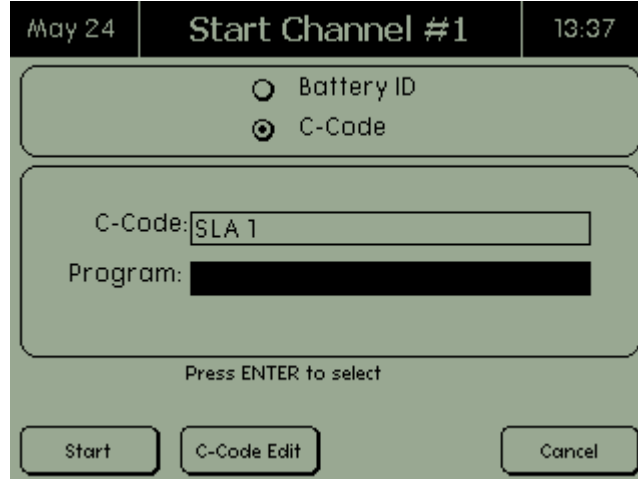
A	Finished	The C8000 will end the current step as a success.
B	Fail	The C8000 will end the current step as a failure.
C	Ignore	The C8000 will ignore this flag and continue the current step.
D	# Retries	# indicates a value between 1 and 10. This option is available for Over-Temperature Alarm bit only. The setting will indicate to the unit the number of SM-Bus samples with the over-temperature alarm bit set before the C8000 will terminate the step as a fail. (Note: SM-Bus is sampled at 15-second intervals.)

### 2.8.1.7 Select a Program to Run

Select a program with which to test the connected battery.

(**Note:** All programs require battery parameters to be established by selecting either a Battery ID or a C-Code. Pressing C-Code “Edit” button, for either Battery ID or C-code can modify the battery parameters).

1. Select the program by battery ID or C-Code.



2. In the *Program* field, press **ENTER**. The **Select Program** screen appears.



3. Select the program to run and press **ENTER**. Note: When scrolling through the list of programs, all factory programs are indented. All custom programs have the creation/modification date of the program at the bottom of the screen.
4. Press **START**. The program begins.

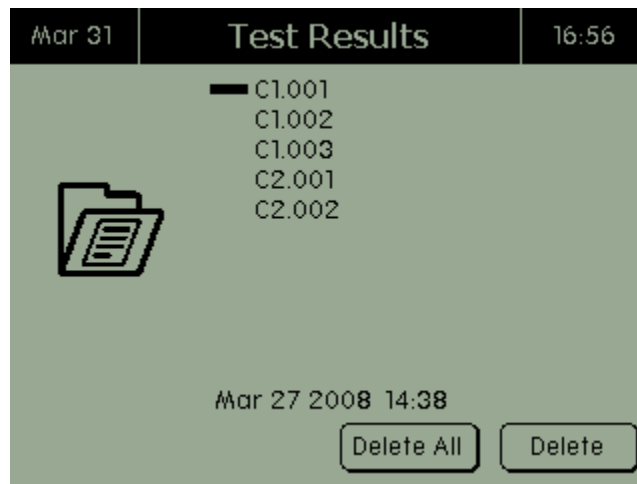


## 2.8.2 Test Results

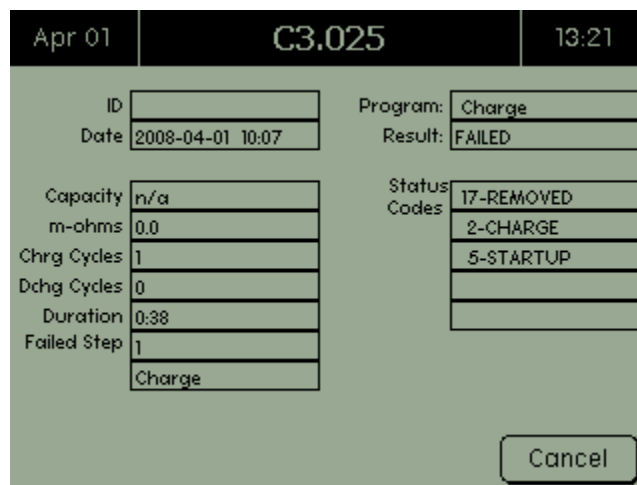
### 2.8.2.1 View Test Results

1. From the C8000 **Main** screen, select **Test Results**. The **Test Results** screen shows the results sorted by battery ID, followed by the sequential number if the test was started using a battery ID or Cx (where x is the channel number, followed by the sequential number).

The date shown is the date the test result file was created for the currently selected test result. Click the <<< and >>> buttons to view the previous and next list of test results.



2. Use the arrow keys to select the test result to view and press ENTER. The **Results** screen appears.



The following table describes the fields that appear in the **Results** screen.

Field	Description
ID	The battery's identification.
Date	The date the test was performed.
Program	The program run during the test.
Result	Indicates whether the battery completed or failed the test.
Capacity	The battery capacity, if available.
m-ohms	Show the battery's results of impedance in milli-Ohms.
Chrg Cycles	The number of charge cycles performed during the test.
Dchg Cycles	The number of discharge cycles performed during the test.
Duration	The time it took to complete the test.
Status Codes	Displays the last five status codes, regardless if test completed or failed.
Failed Step	Displays the step number where the test failed.
Step Name	Displays the name of the step where the test failed.

When finished viewing the results, press **CANCEL**.

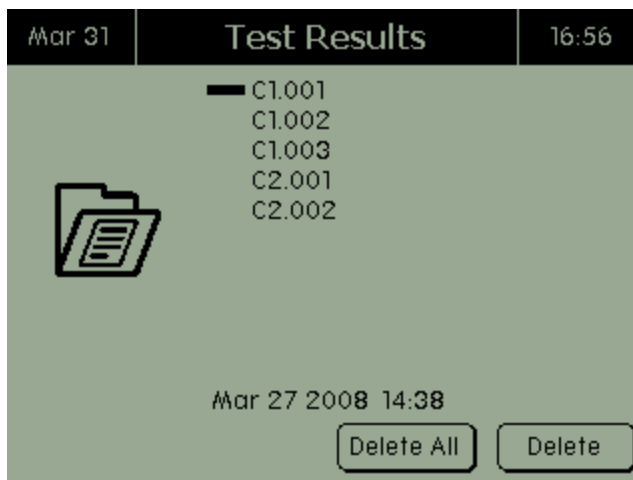
### 2.8.2.2 Print Test Results

Use BatteryLab to print test results. For more information, see [3.6.3 View and Print Test Details](#).

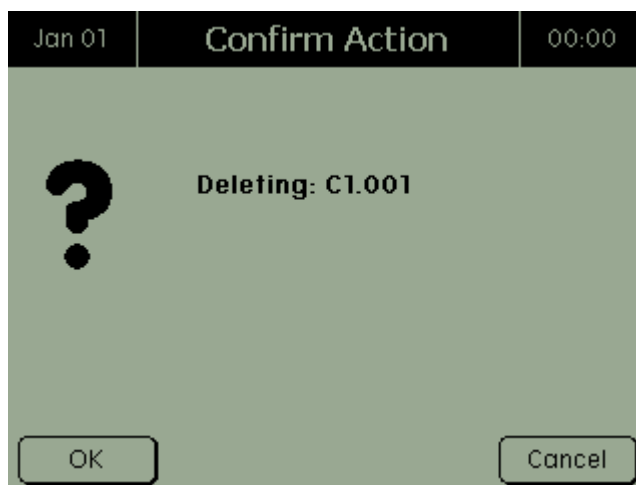
### 2.8.2.3 Delete a Test Result

Delete a specific test result if it is no longer needed:

1. From the **Main** screen, select **Test Results**. The **Test Results** screen shows the results sorted by battery serial number.



2. Select the test result to delete.
3. Press **DELETE**. The **Confirm Action** screen appears.

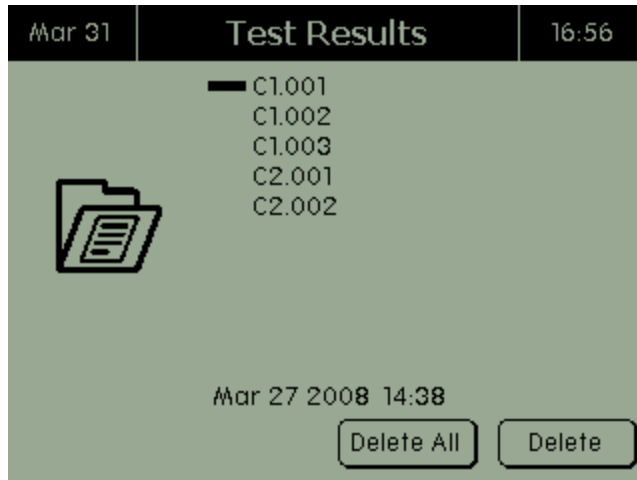


4. Press **OK** to delete the test result.

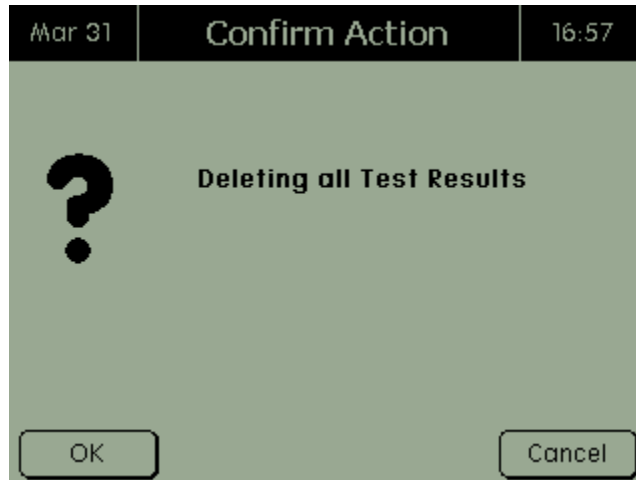
#### 2.8.2.4 Delete All Test Results

To delete all test results:

1. From the **Main** screen, select **Test Results**. The **Test Results** screen shows the results sorted by battery serial number.



2. Press, "DELETE ALL." The **Confirm Action** screen appears.



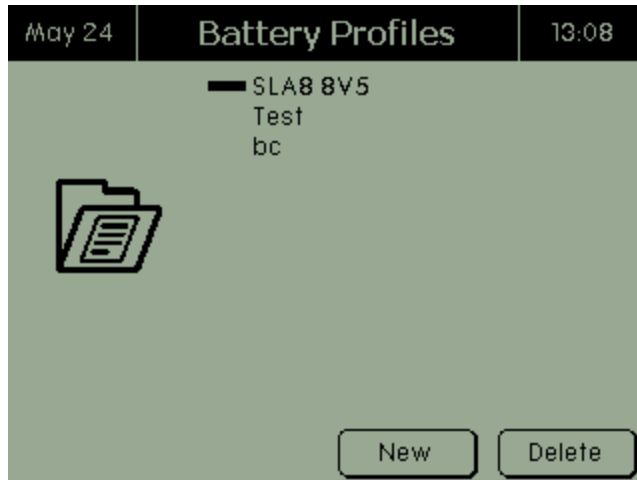
3. Press **OK** to delete all test results.

---

### 2.8.3 Battery Profiles

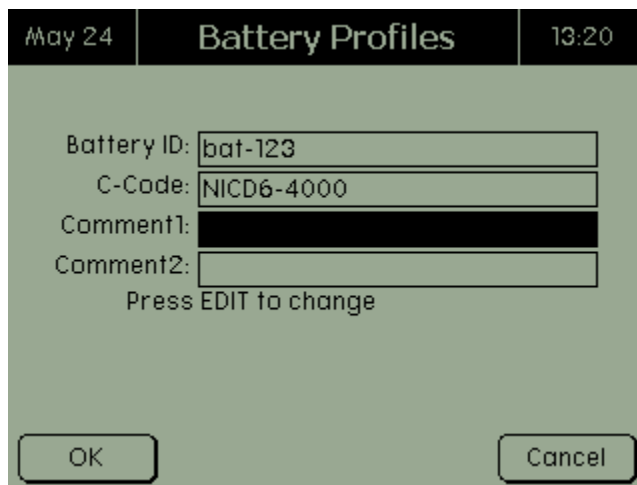
To add, edit, and delete battery profiles in the C8000:

From the **Main** menu, select **Batteries**. The **Battery Profiles** screen appears.



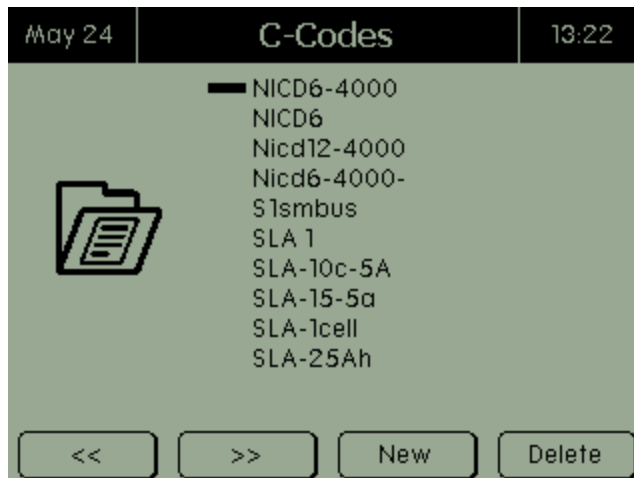
### 2.8.3.1 View and Edit a Battery Profile

To view a battery profile, select the profile in the **Battery Profiles** screen and press **ENTER**. The **Battery Profiles** screen appears.

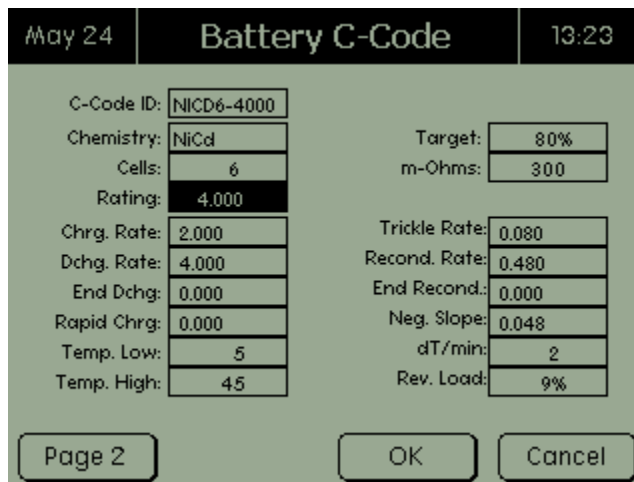


Edit the information for the battery profile, as required, and press **OK** to save the changes.

When adding or editing a battery profile, select the c-code by scrolling to the *C-Code* field. Press **ENTER** to view a list of available c-codes in the **C-Codes** screen.



Select the c-code for the battery profile and press **ENTER**.



For a description of the fields, see [2.9.1.2 View and Edit a C-Code](#).

Edit the details of the battery c-code as required and press **OK** to save the changes. Press **CANCEL** to discard any changes just made to the c-code.

To view the next page of information for this c-code, press **PAGE 2**. The **Page 2** screen appears.

Battery C-Codes	
Min. Voltage:	0.300
Max. Voltage:	10.800
Chrg. Timeout:	150
Dchg. Timeout:	150
NS Delay:	2
Max. Chrg. Current:	8.000
Max. Dchg. Current:	8.000
Max. Temp:	60

Edit the details of the battery c-code as required. (For instructions on editing a c-code, see [2.9.1.2 View and Edit a C-Code.](#)) Press **BACK** to return to the **Page 1** screen.

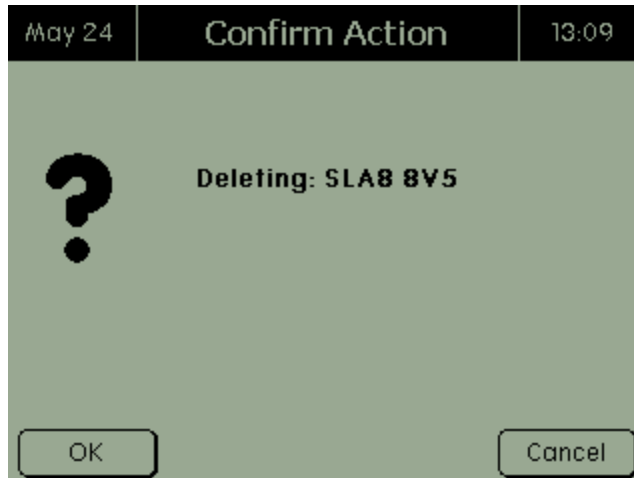
### 2.8.3.2 Delete a Battery Profile

To delete a battery profile:

From the **Main** screen, select **Batteries** and press **ENTER**. The **Battery Profiles** screen appears.

SLA8 8V5  
Test  
bc

Select the battery profile to delete and press **DELETE**. The **Confirm Action** screen appears.

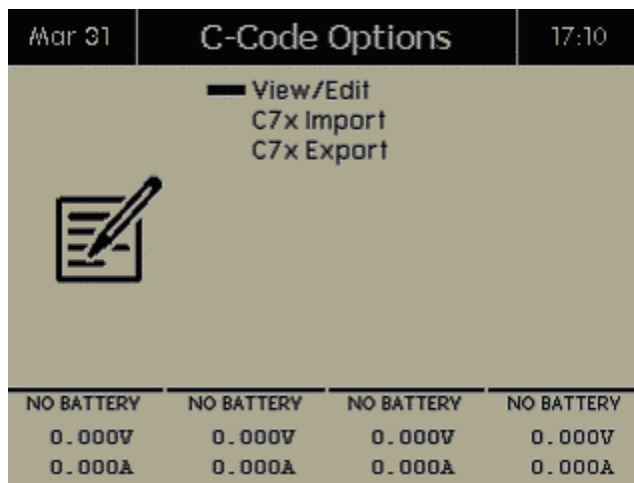


Press **OK** to delete the battery profile. **Note:** The referenced C-Code is not deleted.

## 2.9 C-Codes

To create, view, and edit c-codes, and to import or export c-codes to and from the C8000: (**Note:** The *Import* and *Export* functions apply only to SnapLock/RigidArm Adapters when using the C8000 Adapter Unit.)

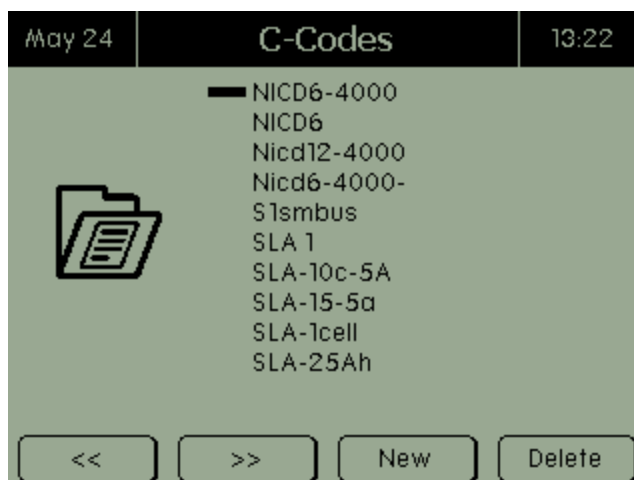
From the **Main** screen, select **C-Codes** and press **ENTER**. The **C-Code Options** screen appears.



### 2.9.1 Add, Edit, and Delete C-Codes

To manage c-codes, select **View/Edit** from the **C-Code Options** screen. The **C-Codes** screen lists the c-codes in the C8000.

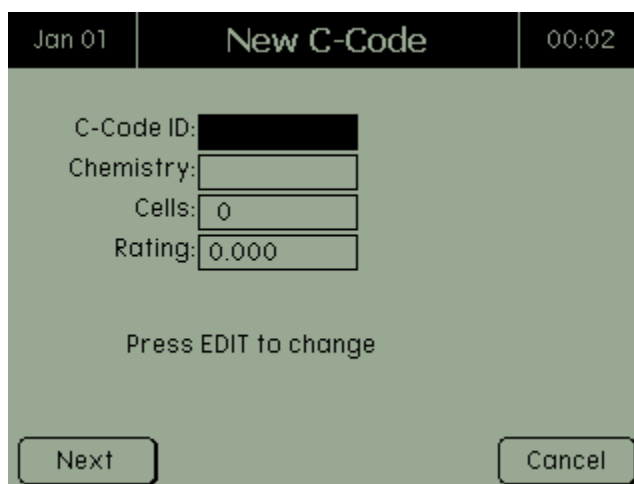




### 2.9.1.1 Create a C-Code

To create a c-code, select **View/Edit** in the **C-Code Options** screen and press **NEW**.

Enter the c-code identification. To select the chemistry, use the **Enter** key or the arrow keys. Press **NEXT**.



Enter the cells and rating and press **ENTER**.

Press **Next** and the battery c-code information appears. Make any required changes and press **OK** to save the changes. See section [2.9.1.2 View and Edit a C-Code](#) for detailed information on the displayed fields.

### 2.9.1.2 View and Edit a C-Code

To view a c-code's information, select the c-code in the **C-Codes** screen and press **ENTER**. The **Battery C-Code** screen appears. (**Note:** This screen may differ slightly, depending on the selected chemistry.)

May 24		Battery C-Code		13:23	
C-Code ID:	NICD6-4000	Target:	80%		
Chemistry:	NiCd	m-Ohms:	300		
Cells:	6				
Rating:	4.000				
Chrg. Rate:	2.000	Trickle Rate:	0.080		
Dchg. Rate:	4.000	Recond. Rate:	0.480		
End Dchg:	0.000	End Recond.:	0.000		
Rapid Chrg:	0.000	Neg. Slope:	0.048		
Temp. Low:	5	dT/min:	2		
Temp. High:	45	Rev. Load:	9%		
Page 2		OK		Cancel	

Edit the details as required and press **OK** to save the changes.

See Section [4 C-Code Parameters](#) for system limitations during C-code Creation.

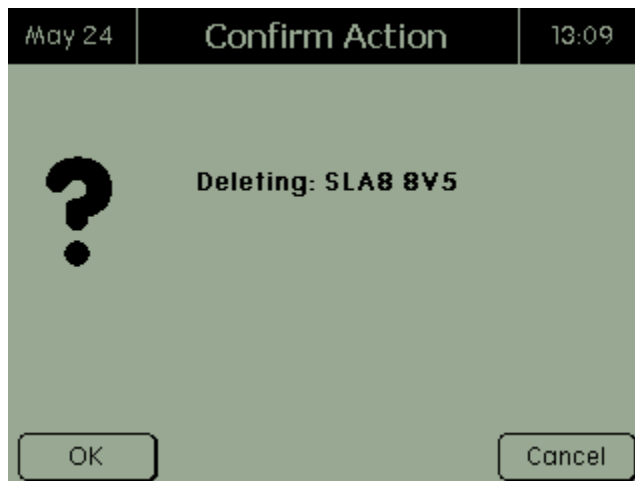
Field	Description
C-Code ID	A unique identification name for the C-Code.
Chemistry	Selects the desired chemistry (Options: SLA/NiCD/NiMH/Li/LiPH/Primary)
Cells	Enter the number of cells. Number of cells supported by Battery chemistry: <ul style="list-style-type: none"> <li>NiCD and NiMH up to 30 cells in series (36 Volts nominal).</li> <li>SLA batteries up to 18 cells in series (36 Volts nominal).</li> <li>Li-ion batteries up to 10 cells in series (36 Volts nominal).</li> <li>LiPH batteries up to 10 cells in series (32 Volts nominal).</li> <li>Primary batteries up to 30 cells in series (36 Volts nominal). Discharge only).</li> </ul>
Rating	The capacity rating of the cell(s) or battery pack. Supported Range 0.050-100 (values are stated in Milli-ampere hour (mAh)).
Chrg Rate	The rate of charge current to be applied. (Unit (A))

Dchg Rate	The rate of discharge current to be applied (Unit (A))
End Dchg	The end-of-discharge voltage (Unit (VV))
Rapid Chrg	The required voltage level for the battery before a full charge current (as per Chrg Rate) is applied. Otherwise, charge current is equal to CTP (LiPh/SLA) or trickle rate (NiCD/NiMH) (Unit (V))
Temp Low	Minimal temperature reading of battery for a current to be applied (Unit (°C))
Temp High	Minimal temperature reading of battery for a current to be applied (Unit (°C))
Target	The minimal capacity value required to determine a Pass/Fail condition. Value is stated in percentage of the total rating field (Unit (%))
m-Ohms	The minimal resistance/impedance value is required to determine a Pass/Fail condition. (Unit (m-ohm)) Range" 1-1000
Trickle Rate	The current rate of charge/discharge when a trickle current is required (Unit (A)) (NiCD/NiMH only)
Record Rate	The rate of discharge during a recondition action step (Unit (AA)) (NiCD/NiMH only)
End Record	The end-of-recondition voltage during a recondition action step (Unit (V)) (NiCD/NiMH only)
Neg Slope	The negative slope value to determine End-of-Charge for NiCD/NiMH batteries only (Unit (mV))
dT/min	The rate of temperature battery temperature increase over a one minute period (Unit (°C)) (NiCD/NiMH only)
Rev Load	Percentage of reverse current to be applied (Unit (%)) (NiCD/NiMH only)
Standby (V)	The rated nominal or standby voltage of the battery (Unit (VV))
Max Chrg (V)	The maximum voltage of a battery for

	Constant Voltage charge (Unit (V)) (SLA/LiPH only)
CTP	End of Charge point for a battery charge (Unit (A)) (SLA/Li/LiPH only)
Min Voltage	The minimal voltage the C8 allows before terminating action (Unit (VV))
Max Voltage	The maximum voltage the C8 allows before terminating action (Unit (VV))
Chrg Timeout	The maximum length of time that a Charge current can be applied before terminating (Unit (C-minutes))
Dchrg Timeout	The maximum length of time that a Discharge current can be applied before terminating (Unit (C-minutes))
Max Chrg Curr	The maximum allowable Charge current allowed to be applied to the battery before terminating (Unit (AA))
Max Dchrg Curr	The maximum allowable discharge current allowed to be applied to the battery before terminating (Unit (AA))
Max Temp	The maximum allowable temperature allowed before terminating (Unit (°C))

### 2.9.1.3 Delete a C-Code

To delete a c-code, select the c-code to delete and press **DELETE**. The **Confirm Action** screen appears.



Press **OK** to delete the c-code.

## 2.9.2 Import a C-Code

To import a c-code from a SnapLock/RigidArm Adapter to the C8000 (an adapter unit is required), select **C7 Import** from the **C-Code Options** screen and press **ENTER**. The **Import C-Codes** screen appears.

The screenshot shows the 'Import C-Codes' screen with the following details:

- Top bar: Mar 31, Import C-Codes, 17:09
- Import from Channel: 1
- Channels 1-10: All are empty input fields.
- Instruction: Use '0' to '9' to select
- Buttons: Save, Cancel

Select the channel to import the c-codes from. The **Import C-Codes** screen appears, showing which c-codes (1-10) were extracted from the SnapLock/RigidArm Adapter.

The screenshot shows the 'Import C-Codes' screen with the following details:

- Top bar: May 24, Import C-Codes, 13:34
- Import from Channel: 1
- Channels 1-10:
 

1.	12-06-160	6.	--empty--
2.	C12ABCDEFG	7.	--empty--
3.	C12ABCDEFG	8.	C1222-10-2
4.	C1012-06-1	9.	--empty--
5.	--empty--	10.	--empty--
- Instruction: Use '0' to '9' to select
- Buttons: Save, Cancel

Next, select the c-codes to import. To select a c-code for import, select the c-code by its corresponding numeric value (0 through 9). The selected c-code is highlighted. This name is used to store the c-code on the SnapLock/RigidArm Adapter.

When finished selecting the c-codes to import, press **SAVE**. The c-codes are imported from the SnapLock/RigidArm Adapter to the C8000. The imported c-code name is renamed with a prefix of *Cxxx*.

### 2.9.3 Export a C-Code

To export a c-code from the C8000 to a SnapLock/RigidArm Adapter (a C8000 Adapter Unit is required), select **SnapLock Adapter Export** from the **C-Code Options** screen and press **ENTER**. Select the c-code to export and press **ENTER**. The **Export C-Codes** screen appears.

The screenshot shows the 'Export C-Codes' screen with the following fields and options:

- Date: Mar 31
- Time: 17:08
- Export to Channel: 1
- Numbered list (1-10): All fields are empty.
- C-Code: [Empty field]
- Export Name: [Empty field]
- Setup #: 0
- Buttons: Save, Cancel

Select the channel to export the c-codes to. The **Export C-Codes** screen shows which c-codes were extracted from the C8000.

The screenshot shows the 'Export C-Codes' screen with the following fields and options:

- Date: May 24
- Time: 13:35
- Export to Channel: 1
- Numbered list (1-10):
 

1.	12-06-160	6.	--empty--
2.	C12ABCDEFGG	7.	--empty--
3.	C12ABCDEFGG	8.	C1222-10-2
4.	C1012-06-1	9.	--empty--
5.	--empty--	10.	--empty--
- C-Code: C1012-06-160
- Export Name: C1012-06-1
- Setup #: 1
- Text: Press EDIT to change
- Buttons: Save, Cancel

The numbered (1 through 10) fields list all c-codes contained within the SnapLock/RigidArm Adapter. In the *C-Code* field, press **Enter** to retrieve a list of c-codes currently on the C8000 and select one. The name of the c-code you just selected appears in the *Export Name* field - you can rename this c-code before you export it, if needed. The *Setup #* field tells the C8000 the memory location on the SnapLock/RigidArm Adapter to save to.

Next, select the c-code to export. To select a c-code for export, select the memory location for the C8000 c-code to be exported to. The selected c-code is highlighted. When finished selecting the c-

code to export, press **SAVE**. The c-codes are exported from the C8000 to the SnapLock/RigidArm Adapter.

1. Select a channel.
2. Select the C8000 C-Code to export.
3. Edit the Export name, if needed.
4. Select the location to export the C8000 C-Code to.
5. Save the C-Code.

---

## 2.10 Programs

The C8000 includes factory default programs. See [3.10.1 Factory Default Programs](#) for information on the default programs.

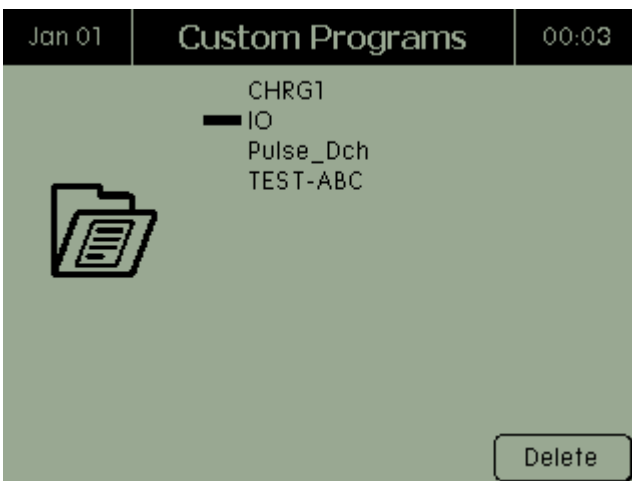
From the **Main** screen, select **Programs**. The **Custom Programs** screen appears.

---

### 2.10.1 View a Custom Program

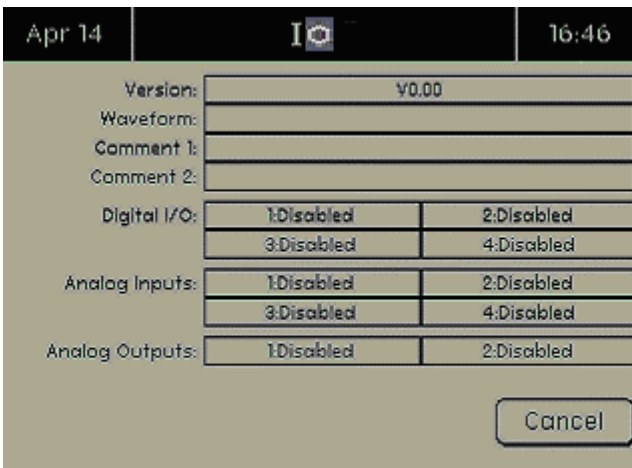
View the details of a custom program.

1. From the **Main** screen, select **Programs**. The **Custom Programs** screen appears.



2. Select the program to view and press **ENTER**. The **Program Details** screen appears. The *Version* field displays the program version that was entered when the custom program was created in BatteryLab, otherwise this field displays *V0.00*. The *Waveform* field displays the custom waveform, if it is associated with the program; otherwise this field is blank. The *Comment 1* and *Comment 2* fields displays any comments for the program that were entered when the custom program was created (the #

indicates the part number). The *Digital I/O*, *Analog Output #*, and *Analog In #* fields display the settings for the port as programmed.

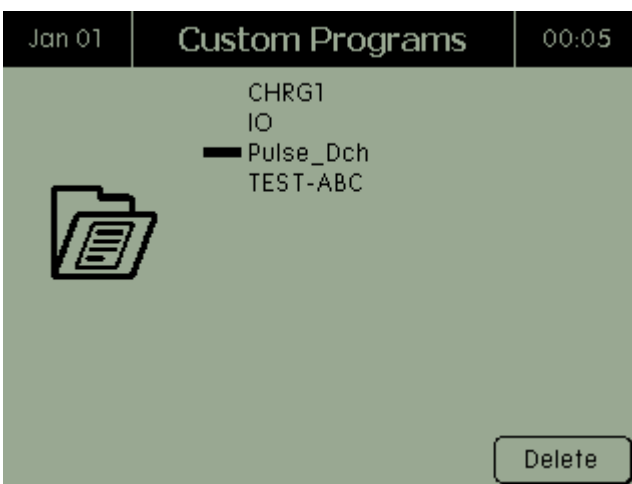


- When finished viewing the information about the custom program, press **CANCEL** to return to the **Custom Programs** screen.

## 2.10.2 Delete a Custom Program

Custom programs can be deleted only if the security setting is set to *Disabled*. For more information on security settings, see 2.12.8 Security.

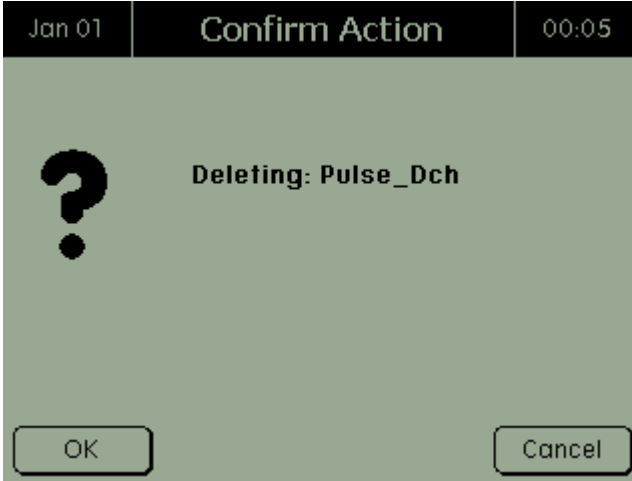
- From the **Main** screen, select **Custom Programs** and press **ENTER**. The **Custom Programs** screen appears.



- Select the custom program to delete.



3. Press **DELETE**. The **Confirm Action** screen appears.



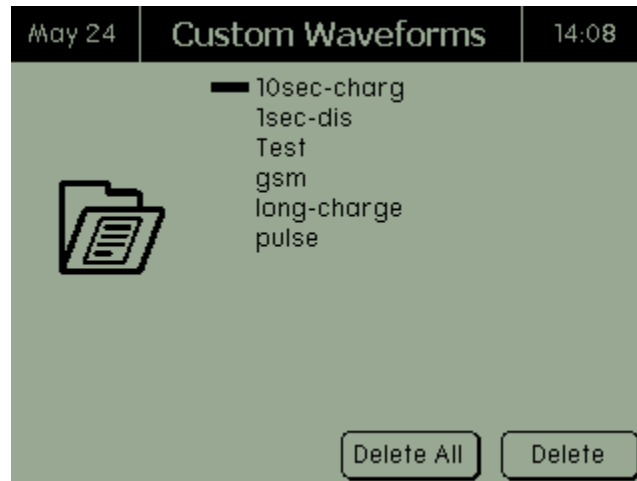
4. Press **OK**.

---

## 2.11 Waveforms

To view information about a waveform or delete one or more waveforms:

From the **Main** screen, select **Waveforms**. The **Custom Waveforms** screen appears.



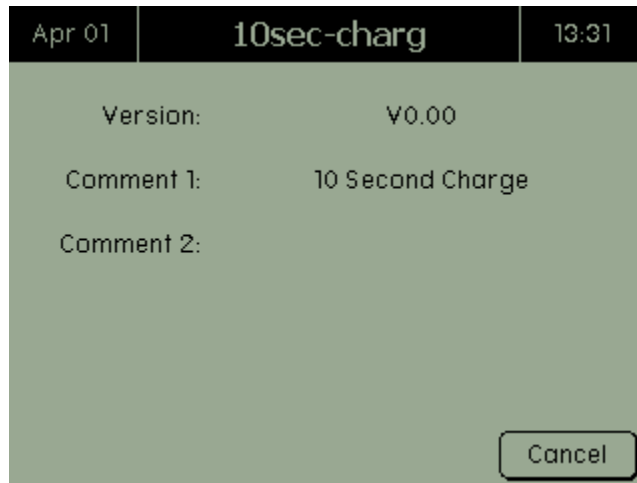
The **Custom Waveforms** screen lists all custom waveforms stored in the C8000.

---

### 2.11.1 View Information about a Waveform

To view information about a waveform:

Select the waveform and press **ENTER**. The screen shows the version, the waveform, and comments about the selected waveform. Note: if a version number is not entered when the waveform is created, V0.00 is displayed.

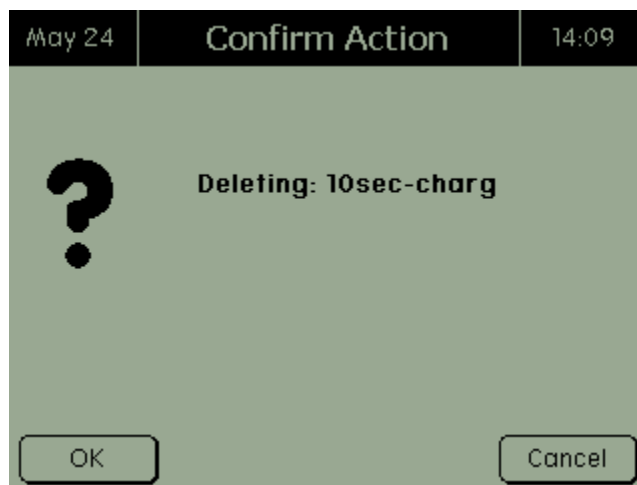


When finished viewing the waveform's information, press **CANCEL** to return to the **Custom Waveforms** screen.

---

### 2.11.2 Delete a Waveform

To delete a waveform, select the waveform to delete and press **DELETE**. The **Confirm Action** screen appears.

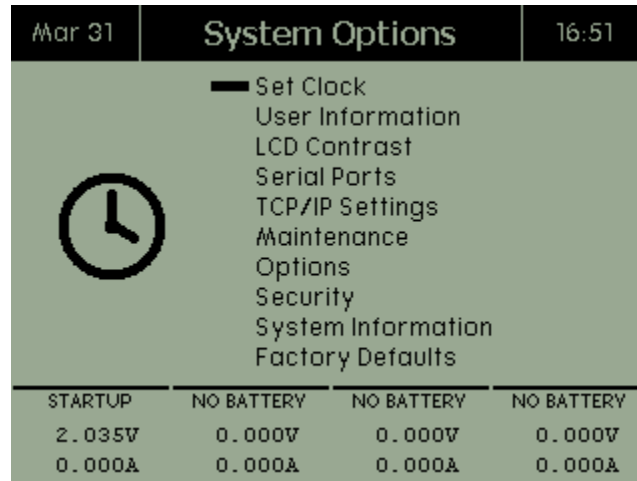


Press **OK** to delete the waveform(s).

## 2.12 Specify System Options

To specify system options on the C8000:

From the **Main** screen, select **System**. The **System Options** screen appears.

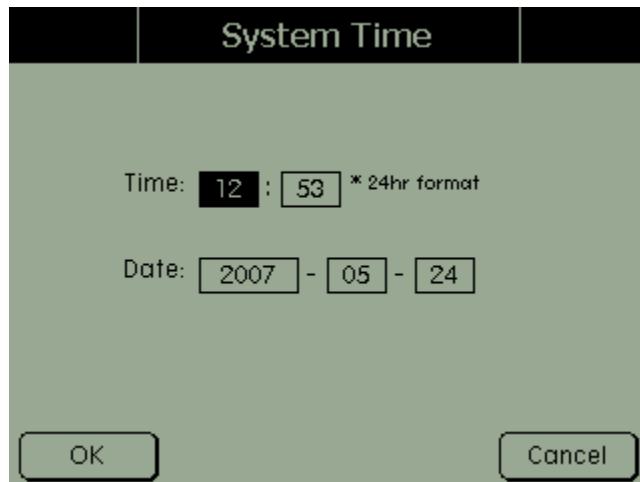


The **System Options** screen shows 10 menu items: *Set Clock, User Information, LCD Contrast, Serial Ports, TCP/IP Settings, Maintenance, Options, Security, System Information, and Factory Defaults.*

### 2.12.1 Set the Clock

To set the time and date on the C8000:

1. From the **Main** screen, select **System** and press **ENTER**. The **System Options** screen appears.
2. Select **Set Clock** and press **ENTER**. The **System Time** screen appears.

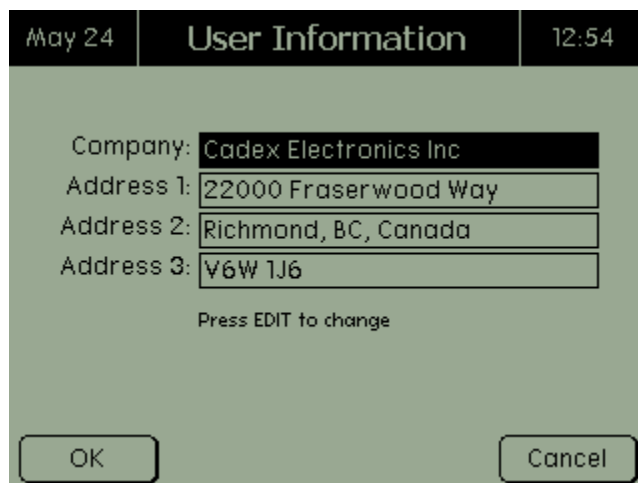


3. Using the numeric keypad, enter the time (in 24-hour format) and the date (year/month/day).
4. Press **OK**.

## 2.12.2 User Information

To enter user information:

1. From the **Main** screen, select **System** and press **ENTER**. The **System Options** screen appears.
2. Select **User Information** and press **ENTER**. The **User Information** screen appears.



3. To activate the onscreen keyboard, press **Edit**. Using the arrow buttons to select alphabetic characters and the numeric keypad to enter numbers, enter the name of the company in the *Company* field.

4. Enter the company's address in the *Address 1*, *Address 2*, and *Address 3* fields.
5. Press **OK**.

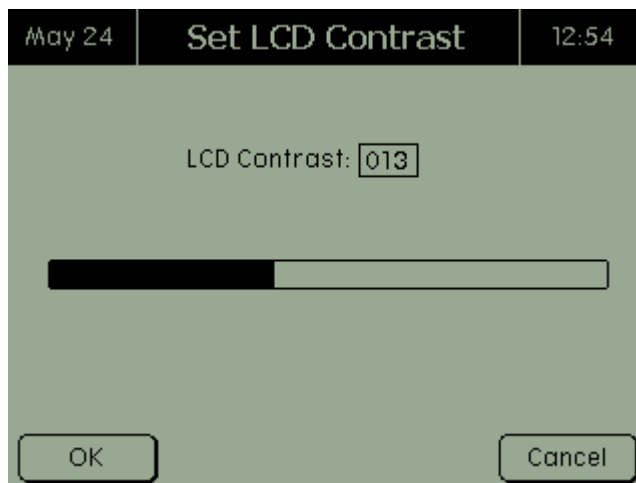
For instructions to enter alphabetic characters see [2.2.1.4 Navigating the LCD Display](#).

---

### 2.12.3 LCD Settings

To set the contrast of the C8000's LCD screen:

1. From the **Main** screen, select **System** and press **ENTER**. The **System Options** screen appears.
2. Select **LCD Contrast** and press **ENTER**. The **Set LCD Contrast** screen appears.



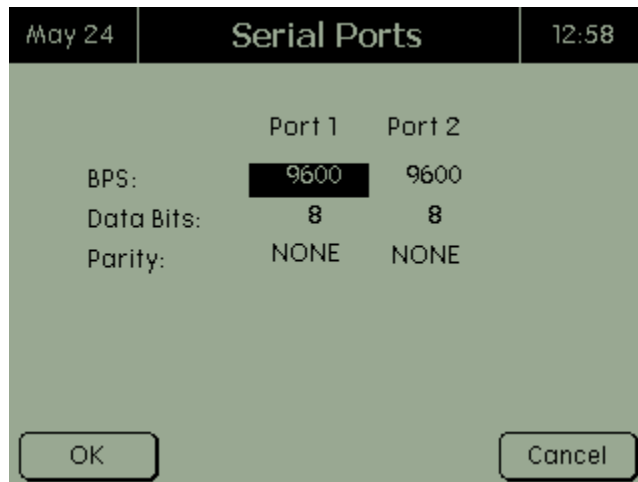
3. Use the ▲ and ▼ buttons to adjust the contrast.
4. Press **OK**.

---

### 2.12.4 Serial Ports

To set the serial ports for the C8000:

1. From the **Main** screen, select **System** and press **ENTER**. The **System Options** screen appears.
2. Select **Serial Ports** and press **ENTER**. The **Serial Ports** screen appears.

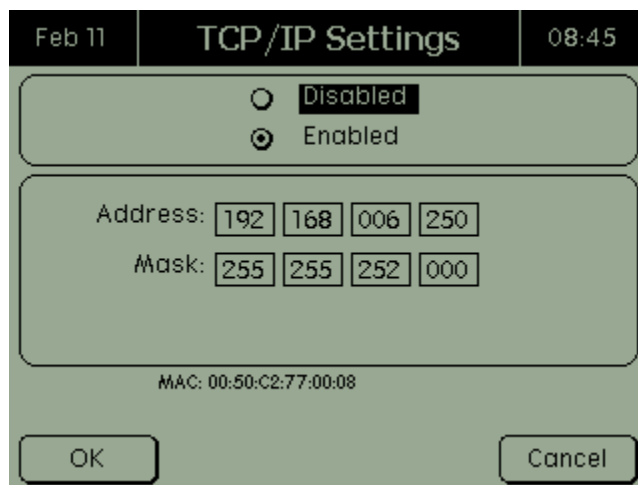


- Use the ▲ and ▼ keys to select the bits per second, data bits, and parity for each port. Use the ◀ and ▶ keys to move to the previous or next field.
- Press **OK**.
- Restart the C8000 after modifications.

### 2.12.5 Specify the TCP/IP Address on the C8000

Note that the TCP/IP addresses **must be static** IP addresses. For more information, see [3.1.10 Selecting a TCP/IP Address](#) for the C8000.

- From the **Main** screen, select **System** and press **ENTER**. The **System Options** screen appears.
- Select **TCP/IP Settings** and press **ENTER**. The **TCP/IP Settings** screen appears.



3. In the **TCP/IP Settings** screen, press ▼ to select **Enabled** and press **ENTER**.
4. Enter the following information:
  - **Address:** This is the IP address for the C8000 from your network administrator.
  - **Mask:** This is the network mask obtained from your network administrator.
5. Press **OK** two times and let the C8000 reboot.

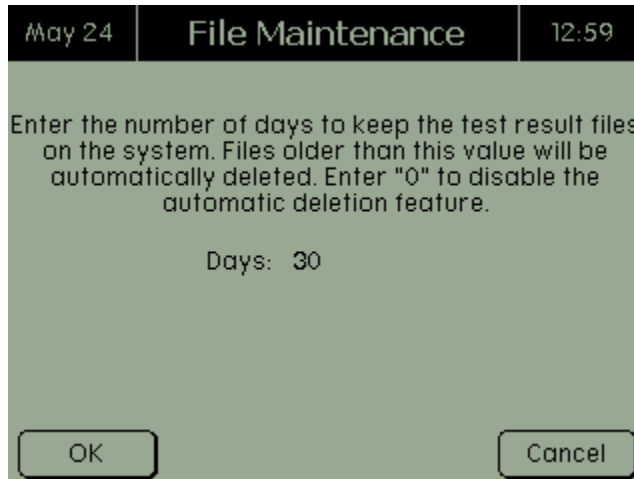
**Note:** *Ensure that the IP Address is unique on the network system and the IP Address assigned to the C8000 has been removed from the DHCP server assignment list.*

---

## 2.12.6 Maintenance

Test results for each battery test are saved on the C8000 and are automatically deleted after the specified number of days.

1. From the **Main** screen, select **System** and press **ENTER**. The **System Options** screen appears.
2. From the **System Options** screen, select **Maintenance** and press **ENTER**. The **File Maintenance** screen appears.



3. Enter the number of days to keep test results. To prevent results from being deleted automatically, enter (0) zero - the default is 30 days.
4. Press **OK**.

---

## 2.12.7 Options

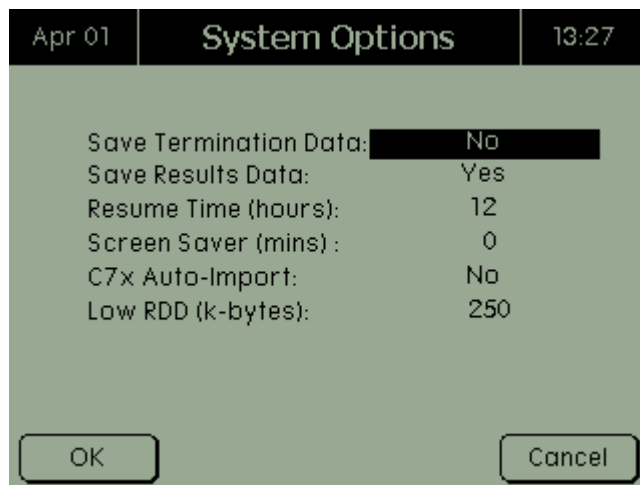
If the *Save Termination Data* option is enabled, the C8000 can capture the last 500 Voltage and Current readings for each

channel. You can specify the capture rate (5-100 readings per second).

If the *Save Results Data* option is enabled, the C8000 saves test results for each completed test. This is open default to ON.

If a power failure occurs while a test is executing, and the power is restored within the specified timeout, the interrupted test will be resumed. To disable this feature, set the *Resume Hours* value to 0 (default value). To enable this feature, set the *Resume Hours* field to any other value.

1. From the **Main** screen, select **System** and press **ENTER**. The **System Options** screen appears.
2. From the **System Options** screen, select **Options** and press **ENTER**. The **System Options** screen appears.



3. To save termination data, select **Yes**.
4. To save results data, select **Yes**.
5. Enter the number of hours before an interrupted test will be resumed.
6. Enter the number of minutes before the screen saver is activated (the default value of 0 will disable this option).
7. To enable SnapLock/RigidArm Adapter auto import, select **Yes** (the default is No).
8. Enter the Low RDD in kilobytes. The default value of 0 means only a console error message is displayed when space reaches zero bytes.
9. Press **OK**.

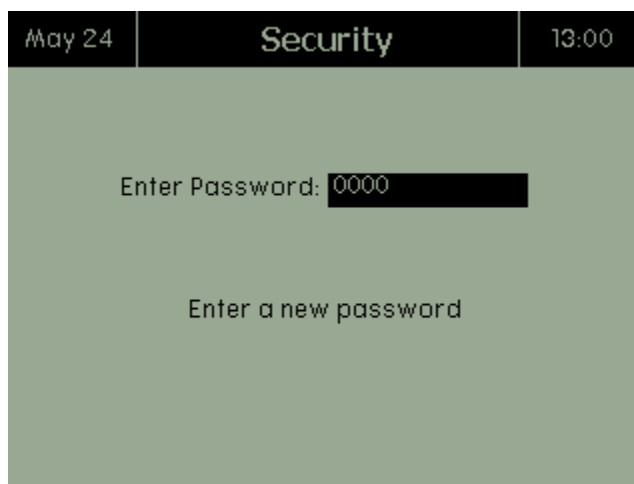


## 2.12.8 Security

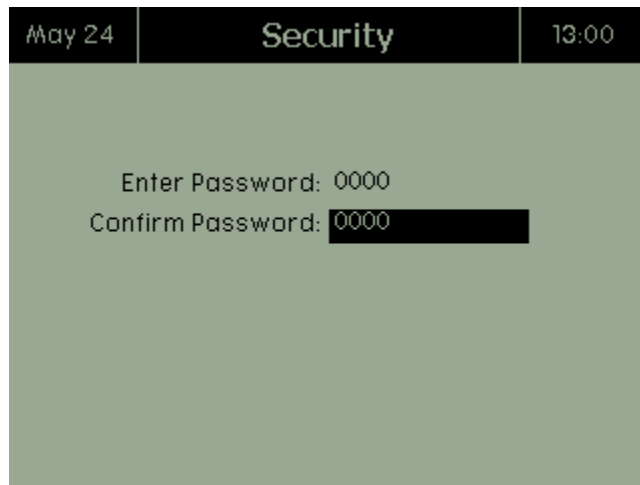
When security is enabled on the C8000, you (or another operator) cannot delete test results or alter c-codes stored in the unit. Note that the password is a numeric password only; alphabetic and alphanumeric characters are not valid in the password.

When security is on (enabled) and the password is entered to disable the security, the security will automatically enable after a reboot or after 10 minutes of no activity. To deactivate the security permanently, disable the security temporarily and enter a new password of "0000".

1. From the **Main** screen, select **System** and press **ENTER**. The **System Options** screen appears.
2. From the **System Options** screen, select **Security** and press **ENTER**. The **Security** screen appears.



3. In the *Enter Password* field, enter your password.
4. In the *Confirm Password* field, enter your password a second time.



5. Press **OK**.

A valid password can be changed in BatteryLab. To receive additional help with passwords, contact Cadex Electronics Inc. or an authorized service center. To disable the password, enter a value of "0000".

## 2.12.9 System Information

To view the C8000's system information:

System information includes the unit number, the version of firmware that is installed, both DSP versions, the LCD version, both PIC versions, the RDD free space, and whether security is enabled or disabled. The units MAC and serial number are also shown.

Each C8000 contains three microprocessors - one Coldfire processor and two Digital Signal processors (DSP). The **System Information** screen reports the versions of both DSP firmware installed in the C8000.

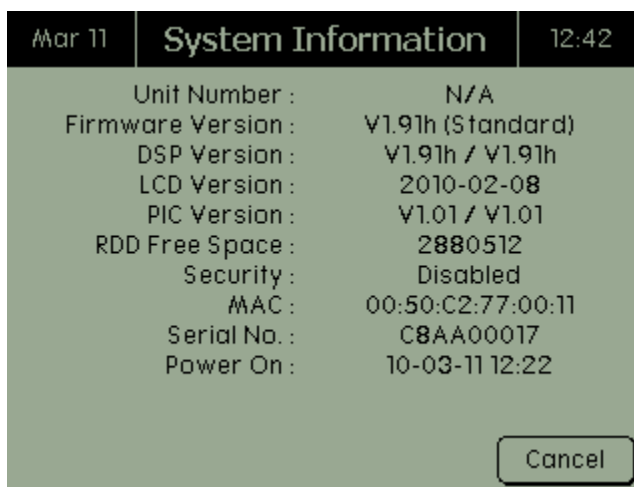
The **System Information** screen displays the version of firmware programmed into the C8000's Liquid Crystal Display (LCD).

Field	Description
Unit Number	The unit number assigned by BatteryLab. N/A indicates in standalone mode.
Firmware Version	The version of firmware installed.
DSP Version	Both versions of the DSP firmware installed on the C8000.

LCD Version	The version of the Liquid Crystal Display.
PIC Version	Both versions of the PIC installed on the C8000.
RDD FreeSpace	The amount of free memory remaining in the C8000, shown in bytes.
Security	Enables or disables the C8000's security feature.
MAC	The MAC version.
Serial No	The C8000's serial number.
Power on time	The last time the C8000 was turned on

The security password enables or disables the C8000's security feature. The default password is 0000 and security features are disabled by default. If a security password is specified, security will be enabled. For more information on setting security passwords, see 2.12.8 Security.

1. From the **Main** screen, select **System** and press **ENTER**. The **System Options** screen appears.
2. From the **System Options** screen, select **System Information** and press **ENTER**. The **System Information** screen appears.

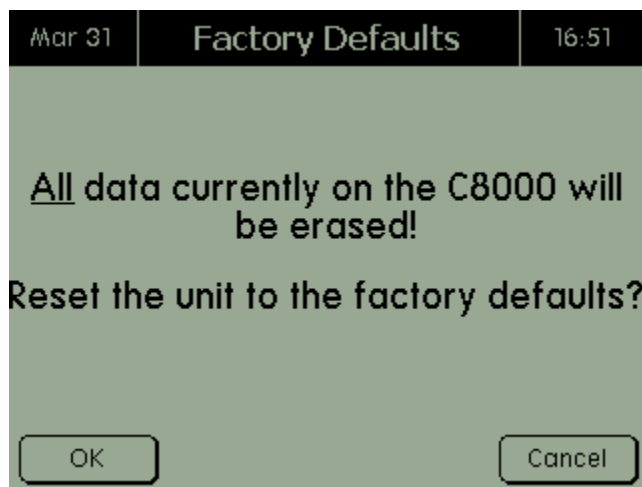


3. Press **CANCEL** when finished viewing the system information.

## 2.12.10 Factory Defaults

Use this option to restore the C8000 back to its factory default settings. **Warning: Restoring factory defaults erases all saved data, customized programs, waveforms, and c-codes. This data should be backed up before proceeding to restore factory defaults.**

1. From the **Main** screen, select **System** and press **ENTER**. The **System Options** screen appears.
2. From the **System Options** screen, select **Factory Defaults** and press **ENTER**. The **Factory Defaults** screen appears.



3. Press **OK** to reset the C8000 to factory defaults.

---

## 2.13 External Devices

The C8000 system supports the following third-party devices VIA the serial ports.

### 2.13.1.1 Programmable DC Electronic Loads

All programmable loads are supported on Serial Port Three only.

#### Connect an electronic load

Configure the external load to communicate with the following settings;

BAUD: 384000 (Recommended), Data bits: 8, Parity: N, Stop Bits: 1

Connect a 9-pin Serial Cable to the C8000 and DC load.

Reboot the C8000.

#### Note:

- 1) Ensure that all waveforms used in conjunction with an electronic load are within the capabilities of the DC load.
- 2) Some DC loads have only a TTL output. Contact the manufacturer of the DC load for a TTL to Serial convertor.

#### Supported DC Electronic Loads

BK Precision 8510 - BK Precision 8514 - BK Precision 8518 - BK Precision 8520

#### BK Precision DC Electronic Load Limits;

- The programming of the DC Load will take between 10~90 seconds to complete. All waveforms will be programmed at the start of the EXTERNAL LOAD steps.
- Minimal pulse width supported by the BK DC Loads is 1ms.

### 2.13.1.2 Thermal Chambers

All programmable Thermal Chambers are supported on Serial Port Two only.

#### Connect to a Thermal Chamber

Configure the Thermal Chamber to communicate with the following settings;

BAUD: 19200 (Recommended), Data bits: 8, Parity: N, Stop Bits: 1

Connect a 9-pin Serial Cable to the C8000 and DC load..

Reboot the C8000.

**Note:** Ensure that all program steps and commands used in conjunction, with the thermal chambers, are within the capabilities of the thermal chamber units.

#### Supported Thermal Chambers

Thermotron 2800 - Thermotron 3800- Thermotron 8800- TestEquity Watlow F4

# 3 Cadex BatteryLab

---

## 3.1 System Setup

Welcome to Cadex BatteryLab – the PC software that provides a visual interface to start, monitor, and control custom battery tests on up to eight Cadex C8000 Battery Testers simultaneously. The software provides interfaces to create or edit password-protected c-codes, battery IDs, waveforms, and custom programs to test batteries. Tests can be viewed in real-time via the results panel or program listing and monitored on multi-variable graphs. (**Note:** *Real-time* is defined as the rate of data acquisition. By default, all data is acquired at a rate of 60 seconds. Programs can be defined to acquire data at a rate of 1 second. Only status code changes are acquired immediately.)

Customizable reports can be generated from historical results retrieved from the database. Test data can also be exported to tab delimited files for further analysis.

---

### 3.1.1 System Requirements

To use BatteryLab, a dedicated Windows - based personal computer (PC) system is needed with the following features: {XE "system requirements for BatteryLab"}

- 1GHz Processor (minimum).
- Windows XP with Service Pack 2, with at least 512MB RAM and 10 GB of free hard drive space.
- An Ethernet Port for primary communication between the PC and C8000.
- A 100-BASE-T Ethernet network switch or hub with sufficient free ports, to connect the hub to the local network, a port for the Host PC, and one for each Cadex C8000 Battery Tester. A switch or hub is not required if the

PC and C8000 are connected directly and are not required to be connected to the local network.

- An SVGA color monitor with 1024 x 768 or better resolution, and 16-bit color minimum.
- A writable CD or DVD drive, for installing software and creating backups.
- A keyboard and mouse.
- A printer.

Correct operation of Cadex BatteryLab requires that a printer driver be installed. Windows comes with an extensive database of printer drivers. Alternatively, commercial software, such as Adobe Acrobat PDF Writer, can be installed as the default printer driver.

---

### 3.1.2 Set Windows Explorer and My Computer to Display File Extensions.

A file extension describes a file type. A filename and its extension are separated by a period ".", for example "Setup.exe". The extension **.exe** indicates an executable program file.

To set Windows Explorer and My Computer to display file extensions in the lists of files:

1. Open Windows Explorer (explorer.exe) or My Computer.
2. From the **Tools** menu, click **Folder Options**.
3. Click the **View** tab.
4. Clear the *Hide extensions of known file types* check box.
5. Click **OK**.

---

### 3.1.3 Create a Database for BatteryLab

To create a database for BatteryLab:

1. Exit BatteryLab.
2. Backup the following two folders to backup media (**Note:** *Installation Location* can be viewed on the **About** window):  
    \*(Installation Location)*\DB  
    \*(Installation Location)*\Export
3. Delete all files in the folder \*(Installation Location)*\DB except the *newc8000.mdb* file. If the *newc8000.mdb* file is

accidentally deleted, retrieve a copy of this file from the backup media and save it to the \ (Installation Location)\DB folder.

4. Copy the *newc8000.mdb* file in the same directory and then rename this second copy to *c8000.mdb*. This way, you can repeat this function multiple times, if required.
5. Start BatteryLab.

---

### 3.1.4 Back Up the Data Files on the PC

All hard disk drives eventually fail, with the loss of all saved data. Hard drive files can also be destroyed or corrupted by: an AC power surge, a computer virus (that slips through antiviral software), failure of electronic parts in the computer, or by human error.



#### Caution

Back up BatteryLab data files regularly onto separate media, such as writable DVD, or CD, or magnetic tape.

It is possible to reinstall software, but the data files on your computer (including test records and calibration data for your C8000s) can be restored only if a backup copy exists.

Scheduled data backups are recommended on a weekly basis using Windows Backup, which is accessed from the **Start** menu: **Start > Programs > Accessories > System Tools > Backup**.

Windows Backup is described in Windows **Help**, which you access from the **Start** menu. Use the Help **Index** to find topics under "Backup".

Using Windows Backup, schedule a periodic backup of the *batlab* folder located, by default, under *C:/Program Files*.

Discuss backup procedure and frequency of backups with your System Administrator.

---

### 3.1.5 Install and Uninstall BatteryLab

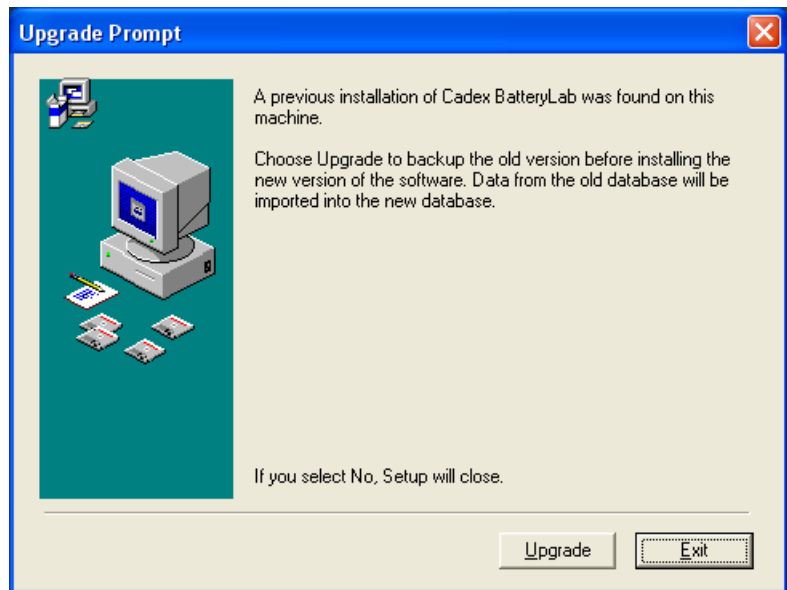
Before installing Cadex BatteryLab, ensure your computer meets the [3.1.1 System Requirements](#) to run the software. BatteryLab and its database can be installed in the default folder locations or different locations, as needed. **Note:** If BatteryLab is already



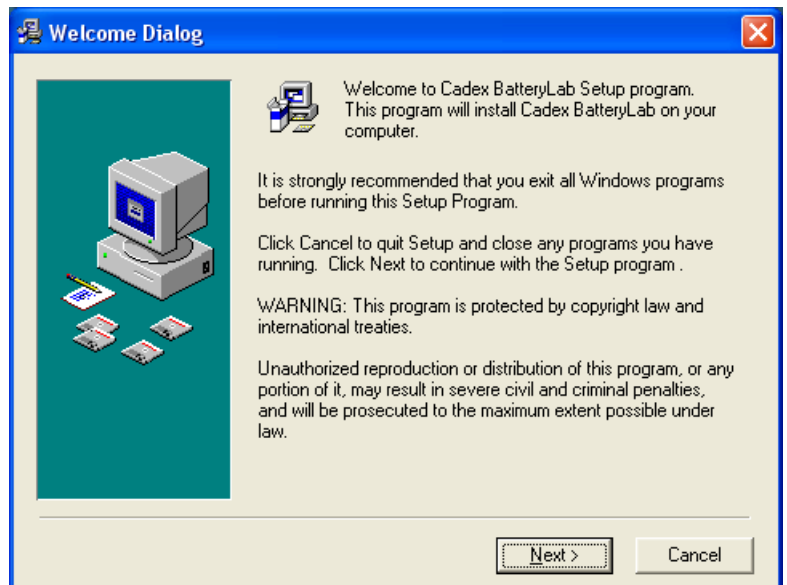
installed, the Upgrade window appears – BatteryLab’s database is automatically preserved during the upgrade.

### 3.1.5.1 Install BatteryLab

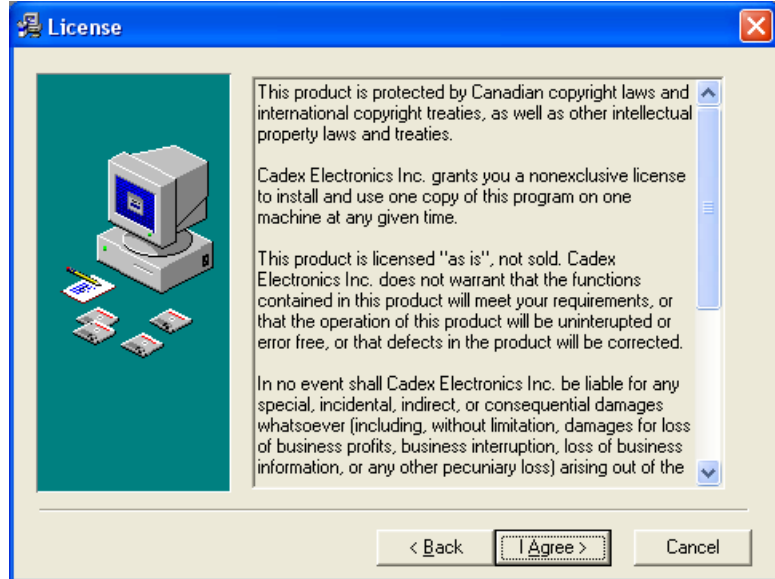
1. Insert the installation CD into the CD drive.
2. Browse your CD drive in Windows Explorer and double-click **Setup.exe**. If BatteryLab is already installed on the computer, the **Upgrade Prompt** window appears. Click **Upgrade** to continue.



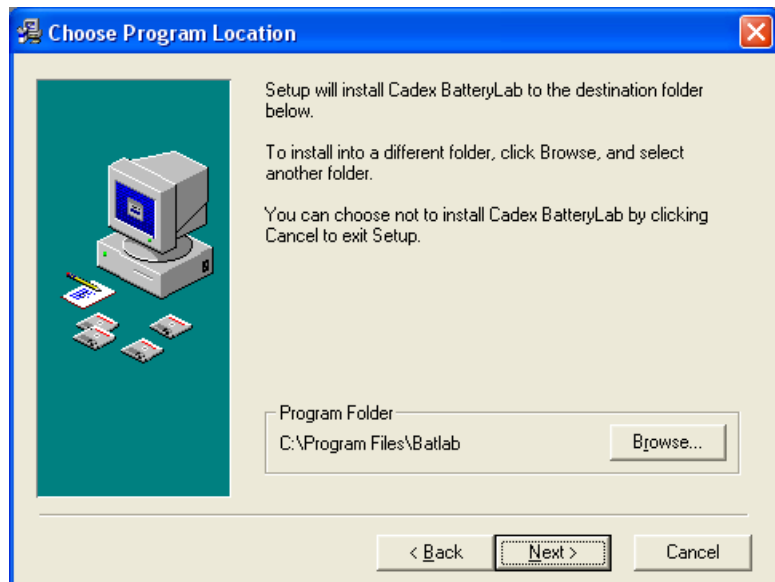
The **Welcome Dialog** window appears.



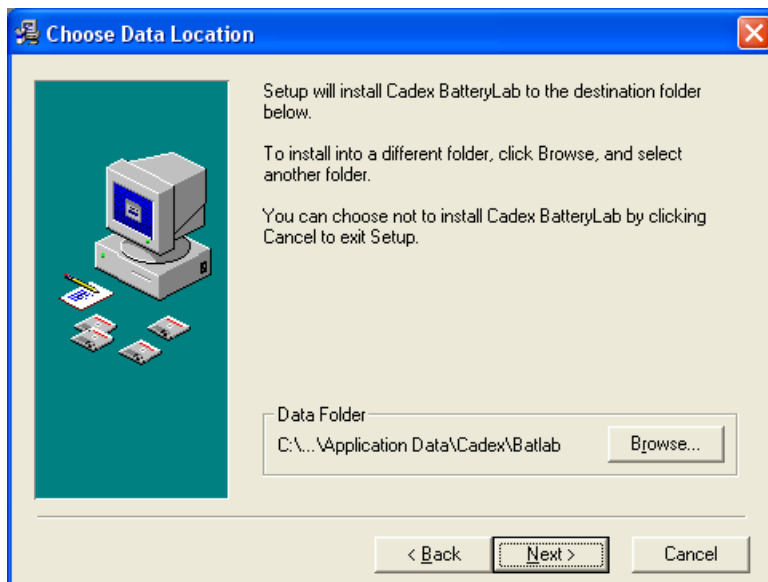
- Click **Next**. The **License** window appears.



- Read the license agreement and click **I Agree**. The **Choose Program Location** window appears.

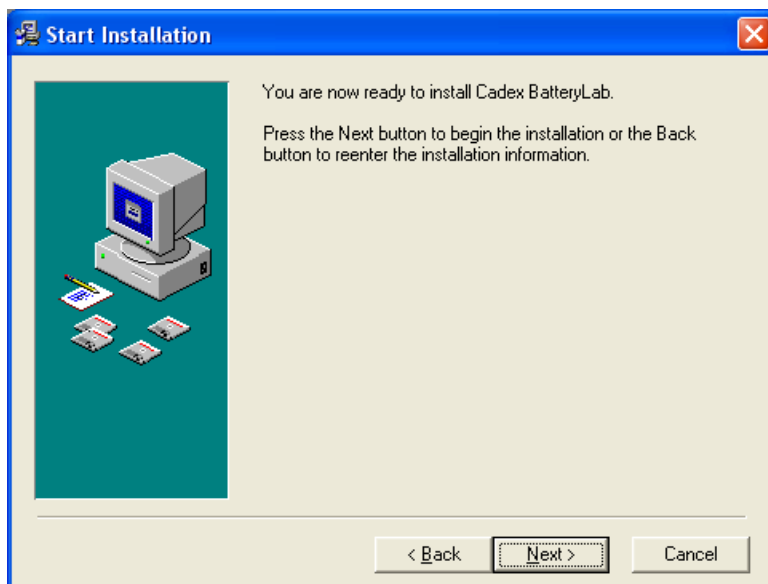


- BatteryLab is installed in the *C:\Program Files\Batlab* folder by default. To install BatteryLab in a different location, click **Browse**. The **Select Destination Directory** window appears. Select the location and click **OK**. If BatteryLab is already installed in that location, the **Install** window appears. Click **Yes** to overwrite the existing copy of BatteryLab.
- Click **Next**. The **Choose Data Location** window appears.

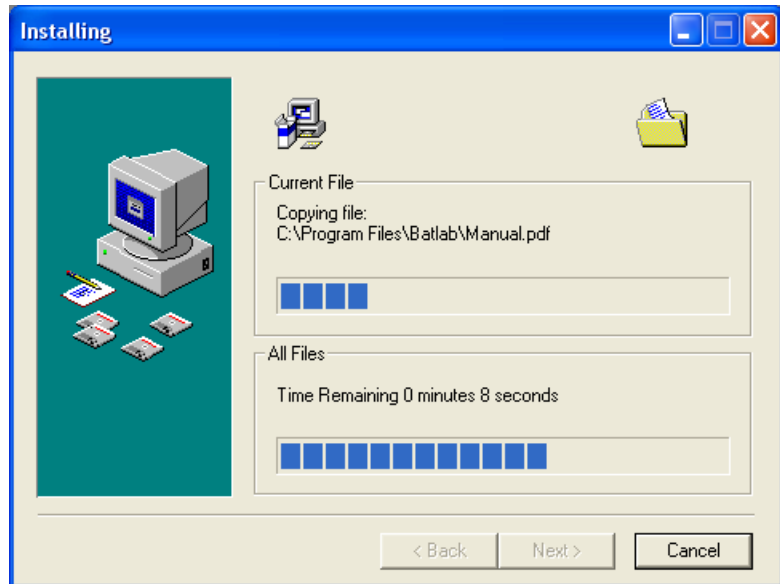


BatteryLab's database is installed in the *C:\...\Application Data\Cadex\Batlab* folder by default. To install BatteryLab's database in a different location, click **Browse**. The **Select Destination Directory** window appears. Select the location and click **OK**. Click **Yes** to overwrite the existing copy of BatteryLab's database.

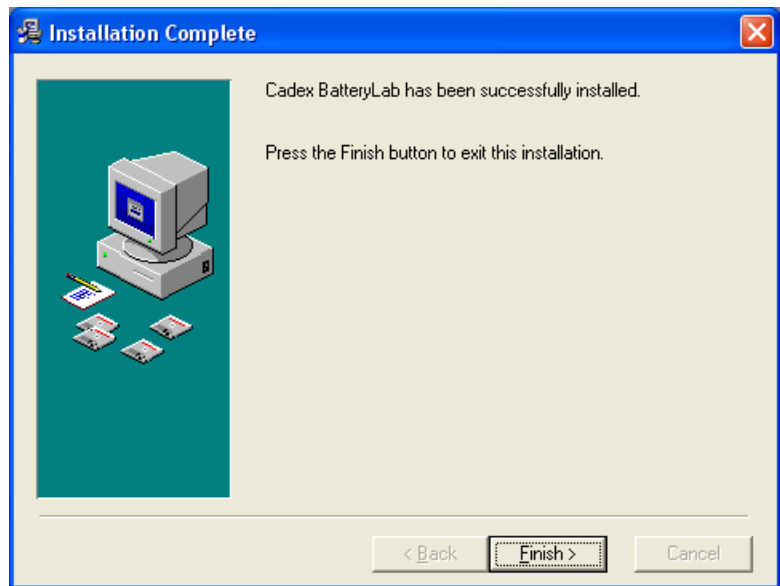
7. Click **Next**. The **Start Installation** window appears.



8. Click **Next**. The **Installing** window appears, showing the files being installed.



9. The **Installation Complete** window appears. Click **Finish**.



### 3.1.5.2 Uninstall BatteryLab

1. In **Control Panel**, click **Add Remove Programs**.
2. Select **Cadex BatteryLab** and click **Remove**.
3. You can select either **Automatic** or **Custom**. If you select **Custom**, select **All** followed by **Next** on each successive dialog box until the software uninstall is complete. If you choose **Automatic**, the uninstall process will retain

shared system components that were installed by the installer during setup.

4. Follow the steps through the uninstall wizard.

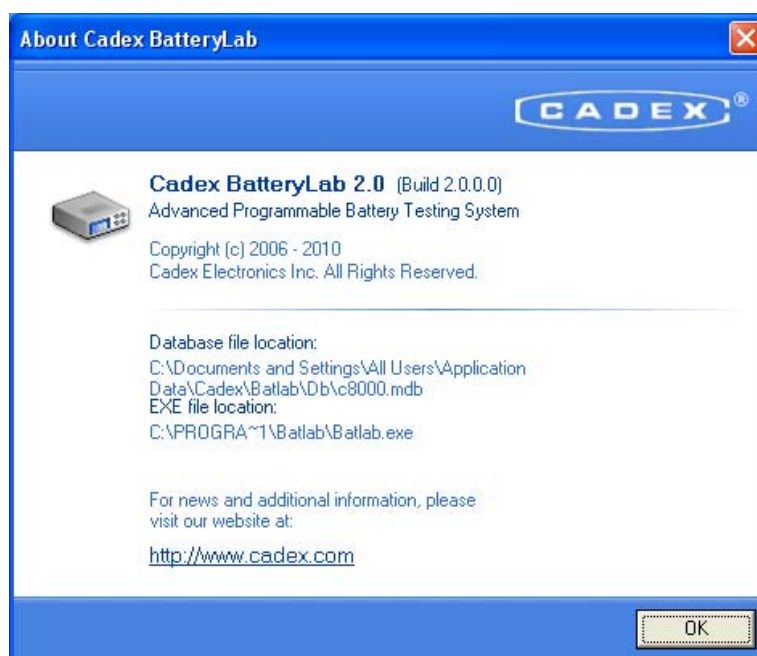
Uninstalling removes all BatteryLab information, including the test results database.

---

## 3.1.6 Software Updates

### 3.1.6.1 Software Version

To see what version of BatteryLab is installed on the computer, select **About** from the **Help** menu. The build number and the location of the database files appears in the **About** window.



### 3.1.6.2 Update BatteryLab Software

When a new version of BatteryLab becomes available, registered users can download it from the Cadex website.

The download is a compressed executable file (with file extension .EXE).

Running the downloaded executable will run **Setup** and install a new version of the software.

**Important**

**If the computer or network uses a firewall, it may be necessary to reconfigure firewall access to the new version of BatteryLab.**

---

### 3.1.7 BatteryLab Security Information

Cadex BatteryLab security serves to secure the software and connected battery analyzers to preserve settings configured by operators who administer the Battery Testing System. Report templates, configuration settings, battery ID databases, c-code databases, programs databases, and waveform database are secured, preventing inadvertent changes by operators.

#### Password Setting

You must have a password to disable BatteryLab security. Note that creating a password does not automatically enable security in BatteryLab and connected analyzers. To enable and disable security, see 2.12.8 Security.

To select a password, select **Password Setting** from the **Database** menu. You must specify a four-digit number, re-type the four-digit number, and then click **OK**.

#### Security Setting

Security setting in BatteryLab is either enabled or disabled. To enable or disable security setting, select **Security Setting** from the **Database** menu. You must specify a four-digit number, re-type the four-digit number, and then click **OK**. You can then enable or disable security setting. For more information, see [3.1.13 Set Security Setting on the C8000](#).

---

### 3.1.8 Set Up BatteryLab

Before starting to test batteries with BatteryLab, set up the following items:

- The cables connecting each C8000 to the network.
- The “Host” IP Address of the PC where BatteryLab is installed and the IP Address for each C8000 connected to the local network.

### 3.1.8.1 Connect the C8000 to the Network

To use BatteryLab with C8000, each C8000 must be connected to the network and be assigned a static IP Address and a network mask.

The static IP addresses for each C8000 must be unique and belong to the same network. For more information on assigning an IP address to a C8000, see [3.1.10.3 Add IP Addresses for C8000s on the PC](#)

Note that the TCP/IP addresses must be **static IP addresses**. A Network Administrator can supply static IP addresses for each device that is to be connected to the local network.

### 3.1.8.2 Set Up the C8000 to Use BatteryLab

The procedure for setting up the network connections is:

- Acquire a unique IP Address from your network Administrator.
- On each C8000, enter a unique IP address and the (network) mask.
- Launch BatteryLab, on the host PC, to enter the IP address for every C8000 that the host PC will communicate with. See [3.1.10.3 Add IP Addresses for C8000s on the PC](#) for information on entering the IP addresses into BatteryLab.

Once the IP address information is entered, connect the C8000 directly to the PC or to a hub/switch connected to the network. Use the Ethernet cable provided. On the C8000 side, the Ethernet cable connects to the Ethernet port at the back of the C8000.

### 3.1.8.3 Choose IP Addresses for the Local Network

An IP address is a set of four numbers that identifies a single computer or device on a TCP/IP network. Each of the four numbers can range from 1 to 254.

1. Click **Start** and choose **Run**.
2. In the **Run** dialog box, type **cmd** and click **OK**.  
The **Command Prompt** window appears.
3. Type **ipconfig/all** in the command prompt window (cmd.exe) and press **ENTER**.
4. Make a note of the **PC IP Address** that is shown in the Command Prompt window under **Ethernet adapter Local Area Connection**.

5. Close the **Command Prompt** window.

The IP address for each C8000 will likely have the same numbers for the first three parts of the PC **IP Address** and a different number, in the range 1-254, as the final part of the IP address. The final number for a C8000 **cannot** be the same as the final number in the IP Address of the PC or the final number in the IP Address of any other device on the Local Area Network.

#### 3.1.8.4 Find the IP Address for Your PC

To find the IP address for your PC:

1. Choose **Start > Programs > Accessories > Command Prompt**.  
The **Command Prompt** window appears.
2. Type *ipconfig* and press **Enter**.  
The IP Address and Subnet Mask for your computer are displayed.
3. **Make a written note** of these numbers and then **close the Command Prompt window**.

#### 3.1.8.5 TCP/IP Settings

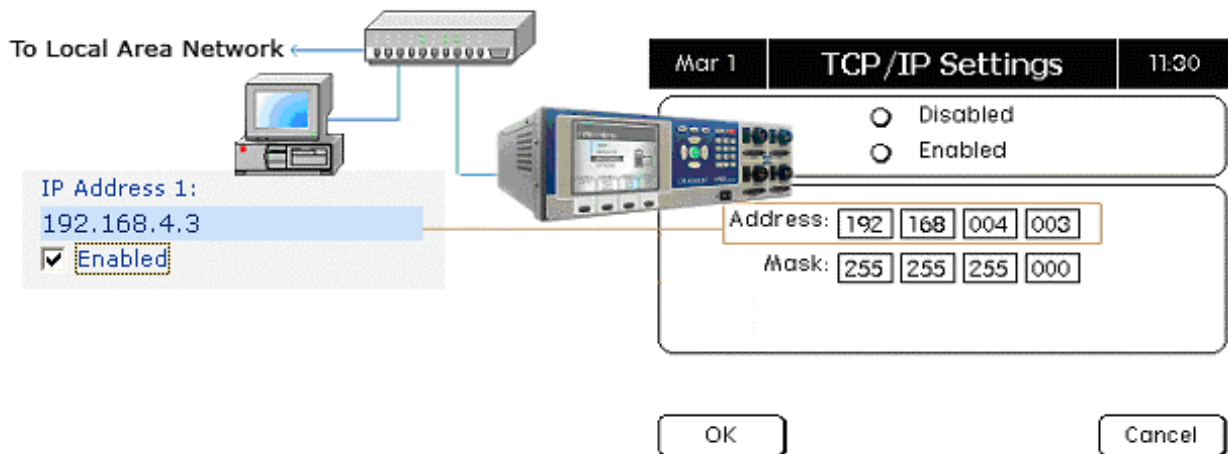
Use the Cadex C8000 standalone or connected to a TCP/IP network and use with Cadex BatteryLab PC software.

In the standalone option, information is specified manually into the C8000 to start tests and test results are accessible via the C8000 display. However, because of hardware memory limits, not all customizable features will be available and the test results must be deleted periodically to make memory available for new test results. A message appears if RDD space is low (space can be configured in *Systems > Options*). (Default: 250 Kbytes)

In the networked option, Cadex BatteryLab software can be used to start tests, store test result histories, and print test reports. Cadex BatteryLab is also required to update the firmware on the C8000. This documentation refers to the computer on which BatteryLab runs as the "host" PC.

The C8000 must be assigned an IP address with a network mask that matches the network mask of the host computer to communicate and update firmware with Cadex BatteryLab.





### 3.1.8.6 Network Cable

A network connection between the computer and C8000 can occur using a hub or switch or directly using the network cable provided.

The host PC's IP address must connect the C8000 to the PC directly via the provided cable.

## 3.1.9 Firewalls

All operating systems from Microsoft windows XP Service pack 2 and newer will by default have a Firewall installed and active or a third party application may have been installed, regardless of the operating system. For BatteryLab to communication with the C8000 a *rule* will be required to be configured and granted or allowed communications to the network.

On the initial execution of the BatteryLab application, the majority of firewall applications will recognize the communication attempt and will prompt the user for permission. Always "ALLOW" or "GRANT" full communication permissions to the BatteryLab application.

Depending on the firewall application the application may be expressed as BATLAB.exe.

If the firewall application does not prompt for permission or BatteryLab has been denied access to the network, refer to the documentation for that firewall for instructions to open the required ports.

See [3.1.9.1 Ports](#) for a list of the required ports, which must be "allowed".

### 3.1.9.1 Ports

The following ports on the PC firewall must be “allowed”.

- TCP port 51935 must remain open.

The required ports are open by default in Windows 2000.

### 3.1.9.2 Other Firewall Software or Hardware

For other firewall software or hardware,

---

## 3.1.10 Selecting a TCP/IP Address for the C8000

### 3.1.10.1 Before Entering the Settings

Ask the Network Administrator for:

- A static IP Address for each C8000
- The network mask

*If the C8000 will be used stand-alone without BatteryLab, then ignore all references to TCP/IP settings for BatteryLab. The TCP/IP Settings on the C8000 are disabled by default.*

An IP address is a set of four numbers that identifies a single computer or device uniquely on a TCP/IP network. Each of the four numbers can range from 0 to 255. If a Network administrator is unavailable, follow the instructions below on a computer to determine a unique IP address for each C8000, other proceed to step 2:

**Note:** *If the network system uses dynamic IP address assignment, ensure that any IP addresses assigned, to a C8000, are exempted from the Dynamic IP Address range of the server/router.*

1. Determine a unique IP address for each C8000 to be connected to the local network.  
Ping the network for each IP address (from the PC) to determine that the IP address is not already in use on the local network. If an IP address is “in use”, determine another unique IP address. To ping an IP address, see [3.1.10.2 Ping the Network to Check for Available IP address](#)
2. To enter a unique IP address for each C8000, follow the steps in the section [2.12.5 Specify the TCP/IP Address on the C8000](#).

IP Address	<p>This is the Internet Protocol (IP) address for the PC on the local network.</p> <p>An IP address is a 32-bit number that is notated by using four numbers from 0 through 255, separated by periods</p>
Subnet Mask	<p>This number identifies the network segment on which the PC is located.</p> <p>A subnet mask is a 32-bit number that is notated by using four numbers from 0 through 255, separated by periods. Typically, default subnet mask numbers use either 0 or 255 as values (such as 255.255.255.0), but other number values can appear.</p>

### 3.1.10.2 Ping the Network to Check for Available IP address

To “Ping” an IP address on the network, enter the keyword “ping” followed by a space followed by the IP address into the Command Prompt window and press **Enter** on the keyboard. If the Command Prompt window is not visible, choose **Run** from the **Start** menu and type "cmd" in the Run dialog and click **OK**. The Command Prompt (cmd.exe) window appears.

Example: “ping 192.168.4.3”

If a device on the local network uses the IP address, the ping response will return a message indicating that the IP address is in use and cannot be assigned to a C8000:

```
Reply from 192.168.4.3: bytes=32 time<10ms TTL=128
```

```
Reply from 192.168.4.3: bytes=32 time<10ms TTL=128
```

```
Reply from 192.168.4.3: bytes=32 time<10ms TTL=128
```

```
Reply from 192.168.4.3: bytes=32 time<10ms TTL=128
```

**Note:** Should the computer receive a reply when the C8000 has not been programmed with an IP Address, select another IP Address.

If there is no device on the local network currently using this address, the ping request will not return a reply indicating that the IP address is available and can be assigned to one C8000:

```
Request timed out.
```

```
Request timed out.
```

```
Request timed out.
```

```
Request timed out.
```

**Note:** Different versions of the Windows operating system may reply differently.

### 3.1.10.3 Add IP Addresses for C8000s on the PC

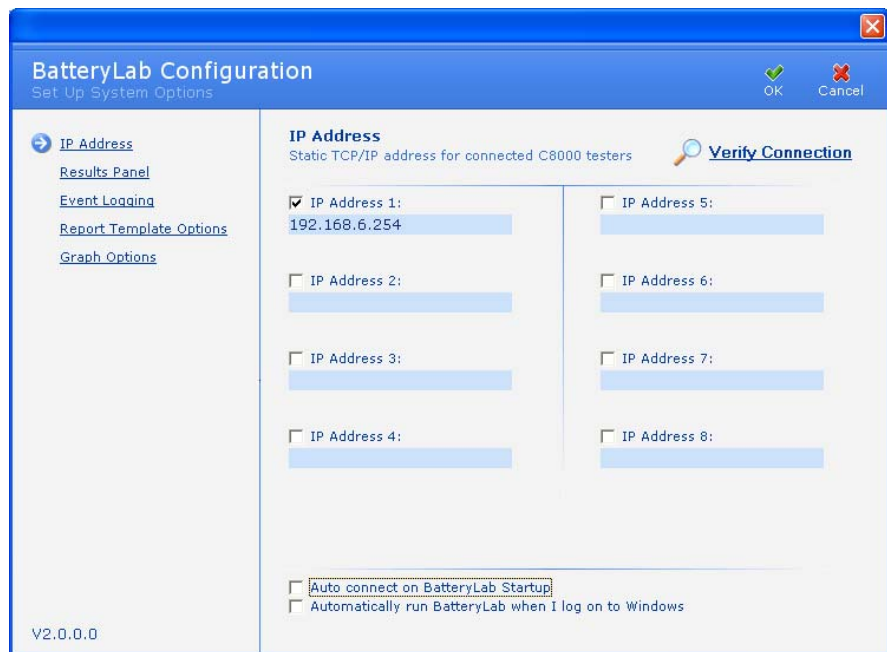
BatteryLab can be set up to communicate with up to eight C8000 Battery Testers, each of which can test up to four batteries simultaneously.

All the C8000s must be switched ON and connected to the network. When there is only one network port available, connect a switch or hub to the network first and then connect the C8000s and PC to this switch or hub.

Assign a static IP address to each connected C8000. Also, specify the network mask into each C8000. For more information, see [3.1.8.1 Connect the C8000 to the Network](#).

To add IP addresses for the C8000 units:

1. From the **Tools** menu, select **BatteryLab Configuration**. The **Set Up System Options** window appears.



2. In the *IP Address* fields, enter the **IP Address** for each C8000 and select the *Enabled* check box. Do **not** enter leading zeros in any of the four parts of an IP address.
3. If you want to verify that a C8000 is available and online, click **Verify Connection**. The firmware version number for each connected C8000 appears in green type below the *IP Address* field.
4. To configure BatteryLab to automatically establish connections with C8000s on startup, select the *Auto Connect on BatteryLab Startup* check box.
5. To automatically execute BatteryLab on logon, select the *Automatically run BatteryLab when I log on to Windows* check box. In case of a power loss, the PC can be forced to restart and resume logging the service (test). First, configure the PC's BIOS to auto-resume on power loss (see the PC's Motherboard manual on how to set the BIOS). **Note:** Not all BIOS are capable of auto-power on AC power loss. Next, configure the Windows operating system to automatically log on using the same user profile as BatteryLab (see the Windows technical guides for information on configuring Windows). When used in conjunction with the C8000's Automatic Resume on Power Loss function, BatteryLab can resume logging data after an AC power loss (see [2.12 Specify System Options](#)).

- Click **OK**.

### 3.1.10.4 Disable an IP address

To temporarily disable communications with a C8000, clear the *Enabled* check box for the IP address:

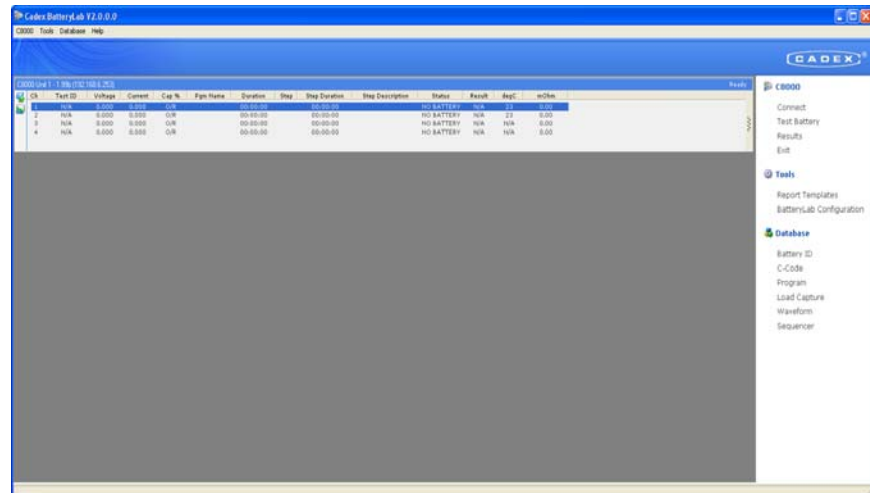
- Open the **IP Address Manager**.
- Under the IP address, of the C8000 to disable, clear the *Enabled* check box.
- Click **OK**.

## 3.1.11 Start the BatteryLab Program

To execute BatteryLab, double-click the **BatteryLab** icon on the desktop.

If there is no BatteryLab icon on the desktop, from the **Start** menu, select: **Programs > BatteryLab > BatteryLab**.

The main window for BatteryLab appears.



### 3.1.11.1 The Menu Bar

The menu bar on BatteryLab's main window displays four menus: C8000, Tools, Database, and Help. Clicking any of these menus displays a list of menu commands.

#### The C8000 Menu

Click the *C8000* menu item to see the **C8000** menu. The **C8000** menu contains 15 menu items, as follows:

*Connect*: BatteryLab will detect connected devices specified in IP Address Manager. **Note** that connection will occur automatically

if the *Auto Connect on BatteryLab Startup* option is enabled in IP Address Manager's settings.

*Disconnect:* BatteryLab disconnects from the active C8000.

*Test Battery:* Starts a test on a battery for the active channel of the C8000.

*Results:* Short Cut to the **Results** window.

*Data Monitor:* Displays a log of system activity between the PC and the C8000s.

*Alerts Window:* Displays any warning or error condition, which BATLAB or a C8000 has reported.

*Suspend Program:* Suspend a program that is running, on the selected channel of the C8000.

*Resume Program:* Resume a program that has been suspended on the selected channel of the C8000.

*Abort Program:* Aborts a program that is running on the selected channel of the C8000.

*Real-Time Status:* View the real-time statuses for the selected C8000 channel.

*Set Clock:* Sets the computer's clock for one or all C8000s.

*Set Options:* Sets the system options for the selected C8000 or all C8000s.

*External Device Info:* Retrieves the model information for the supported external devices that are currently connected to the selected C8000.

*System Info:* Retrieves the system information for the selected C8000.

*Exit.* Select the *Exit* menu item to close the BatteryLab application.

### **The Tools Menu**

Click the *Tools* menu to see the **Tools** menu. The **Tools** menu contains three menu items, as follows:

*Report Templates:* Displays the **Report Template** window to create report templates.

*BatteryLab Configuration:* Displays **BatteryLab Configuration** window; to specify IP addresses for C8000s that will connect to BatteryLab fields; to configure the fields to display in the **Results Panel**, to indicate the location for event log; to configure the report header fields and default printer; to setup the default display fields, for all graphs

*System Update*: Displays the **System Update** window to update firmware or to backup and restore calibration data.

### The Database Menu

Click the *Database* menu item to see the **Database** menu. The **Database** menu contains eight menu items, as follows:

*Battery ID*: Displays the **Battery ID Database** window.

*C-Code*: Displays the **C-Code Database** window.

*Programs*: Displays the **Programs Database** window.

*Load Capture*: Displays the Load Capture programs database.

*Waveforms*: Displays the **Waveforms Database** window.

*Sequencer*: Displays the **Sequencer** window.

*Security Setting*: Enables or Disables the **C8000 and BATTERYLAB Security Setting**.

*Password Setting*: Displays the **Password** window.

### The Help Menu

Click the *Help* menu item to see the **Help** menu. The **Help** menu contains two menu items, as follows:

*Contents F1*: Displays the **Help** window.

*About*: Displays the **About** window, which shows details about the BatteryLab application.

---

## 3.1.12 Set the Clock on the C8000

From the C8000 menu, select **Set Clock** and then select **Selected C8000** or **All connected C8000(s)**.

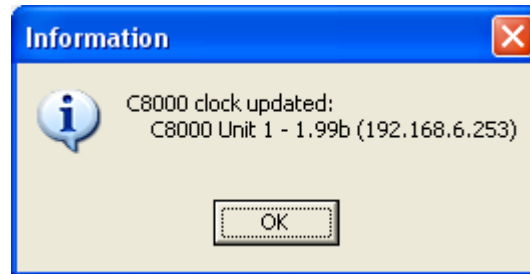
The **Password** window appears, if security is enabled.





Enter your password and click **OK**.

An information window appears indicating a list of the C8000 that the clock was updated. **Note:** Do not update the C8000 clocks if there are any batteries connected.



---

### 3.1.13 Set Security Setting on the C8000

Security setting in BatteryLab is either enabled or disabled. To enable or disable security setting, select **Security Setting** from the **Database** menu. Next, select the *Enable* or *Disable* option. The **Password** window appears. Enter a four-digit number, re-type the four-digit number, and then click **OK**. Security setting is updated.

Select the *Enable* option to enable system security in BatteryLab and on all connected analyzers. Connected analyzer windows will display a padlock indicating security is enabled on the analyzer.

**Note:** If system security is enabled, attempts to import battery IDs, c-codes, programs, and waveforms from connected analyzers to overwrite existing BatteryLab files are denied. Attempts to start tests on secure connected analyzers with new custom programs, c-codes, and battery IDs require a valid password. Attempts to change Report Templates and BatteryLab Configuration are denied. Attempts to start tests with programs, c-codes, and battery IDs already on the secure connected analyzer are allowed. Attempts to export c-codes, programs, or waveforms from BatteryLab to secured analyzers are denied.

Select the *Disable* option to disable system security in BatteryLab and on all connected analyzers.

### 3.1.14 Set the Password to Configure C8000 Functions

To secure functions that configures the C8000 (such as Set Clock, Set Options, etc):

1. Select **Password Setting** from the **Database** menu. The **Password** window appears.



2. Enter your password and click **OK**. The **Password Updated** window appears.

**Note:** Password verification is required if a password is already existing.

### 3.1.15 C8000 Settings

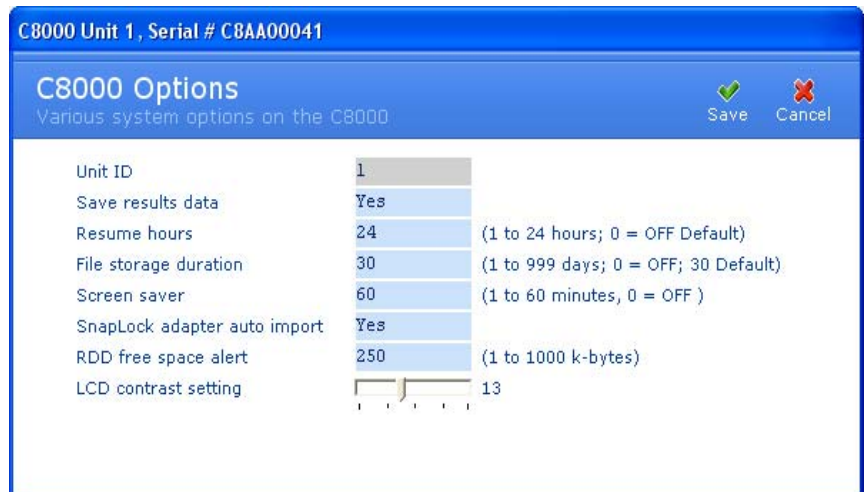
BatteryLab can customize system options on the C8000

1. From the **C8000** menu, select **Set Options**.
  - i. The **Password** window appears, if security is enabled.



2. Enter your password and click **OK**.

3. The **C8000 Options** window appears.



4. In the *Save Results Data* field, click the field and select *Yes* or *No*. The C8000 saves the results for all tests performed if set to *Yes* (recommended). For more information, see 2.12 Specify System Options.

5. In the *Resume Hours* field, enter a value 0-24 where 0=off. The C8000 will resume a test if this option is set after a power interruption. The C8000 will only resume a service, after a power interruption, up to the number of hours specified. For example, if the unit is set to 2 hours, and a service is interrupted because of power failure, the C8000 will resume the test only if the power is restored within 2 hours.

6. In the *File Storage Duration* field, enter a value 0-999, where 0=off. This is the number of days the C8000 will keep all test results before automatically deleting all files that are older than the specified number of days. **Note** that no warning is issued before deletion.
7. In the *Screen Saver* field, enter a value 0-60, where 0=off. This is the number of minutes before a Cadex screen saver is enabled. (If pixel retention occurs, the active screen saver and the pixel retention will be corrected.)
8. In the *SnapLock Auto Import* field, select Yes or No. This option automatically imports all c-codes stored on a SnapLock/RigidArm Adapter, when inserted. (**Note:** C-codes will remain until the adapter is removed.) The naming scheme used during auto-import is as follows: The assigned name will be "C7xyy" where x=Channel # (1-4), yy=c-code # (location) in the adapter (01-10). For example, a c-code imported from Channel 3, with a C-Code in memory location #1 would be: C7301.
9. In the *RDD Free Space Alert* field, enter 0-1000 (kilobytes). The C8000 will issue a warning when the available free space reaches or surpasses the specified value.
10. Adjust the LCD contrast for the C8000 by moving the slider to the left or right. **Note:** Moving the cursor to the right will darken the screen, while moving the cursor to the left will lighten the screen.
11. Click **OK**.

---

### 3.1.16 Alert Window

The **Alert** window may appear when BatteryLab is first executed and will display a warning or error information.

For each warning/error condition, the **Alert** window displays the unit number and IP address of the C8000 that has issued the warning; the date and time the warning occurred; the test identification number (ID) of the service issuing the warning, and text with an explanation of the warning/error. The **Alert** window may also display information on how to correct the warning/error condition.



Click **Clear** to erase the error message. Click **Copy to Clipboard** to copy the error information to the Windows Clipboard – the error information can then be copied to another Windows application.

All warning/error messages are displayed in the sequence of issue.

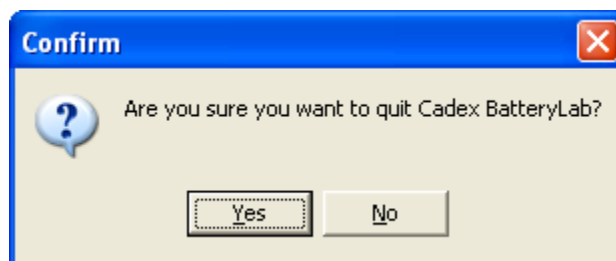
To view information about the next warning/error condition, click **Next**. To view information about the previous warning/error condition, click **Prev**.

Click **Close** to close the **Alert** window. **Note:** Closing the window will erase any warning that have been issued, from the **Alert** window. All C8000 service warning/error(s) will be recorded in the Test record for the service.

---

### 3.1.17 Exit BatteryLab

From the C8000 menu, click **Exit** to terminate BatteryLab. The **Confirm** window appears.



Click **Yes** to close the BatteryLab application.

## 3.2 Configure BatteryLab

### 3.2.1 Results Panel

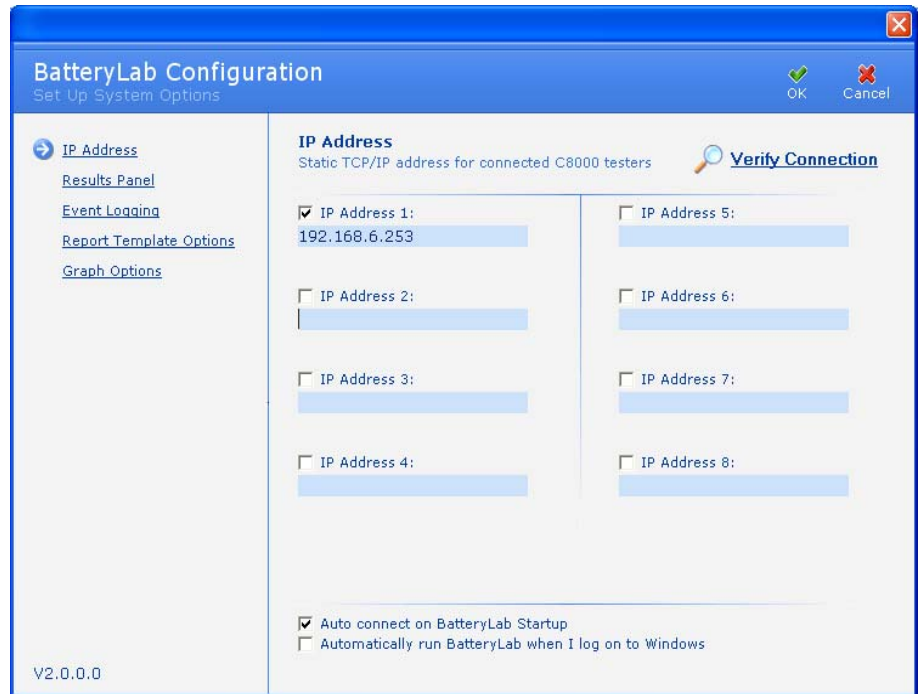
BatteryLab can be customized to display specific fields in the **Results** window. The *Available Fields* column lists the fields that can be displayed in the **Results** window. The *Display Fields* column displays the fields that will be displayed in the **Results** window.

The following table describes the variables that are available for display by the **Results** window.

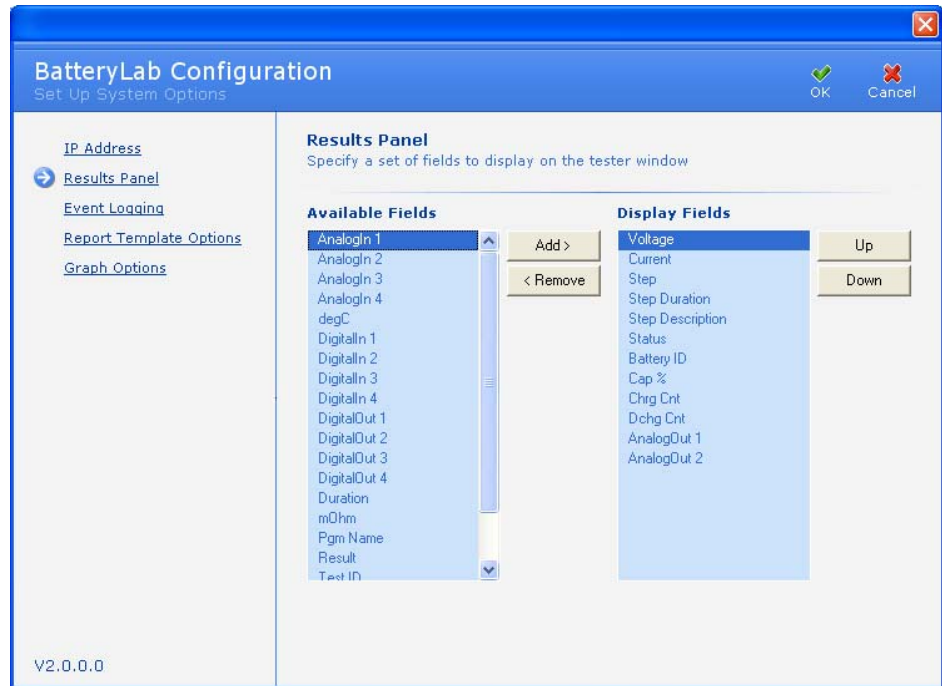
<i>Variable</i>	<i>Description</i>
Voltage	Voltage reading from the C8000
Current	Current reading from the C8000
Step	Current step within a program
Step Duration	The duration of the current step
Step Description	A user-defined description of the current step
Status	The current status of the C8000 channel or program
Pgm Name	The executing program's name
Result	The test result of the current program
Test ID	Test Identification (ID) number that has been assigned automatically to the service/test
Duration	The total duration of the entire program
Cap %	Capacity reading from the C8000
Chrg Cnt	Number of Charge steps that have been applied during the program
Dchg Cnt	Number of Discharge steps that have been applied during the program
Battery ID	The Battery Identification (ID) that has been assigned.
AnalogOut1	Voltage level of the first Analog output
AnalogOut2	Voltage level of the second Analog output
DigitalOut1	Status of Digital 1 when configured as an output
DigitalOut2	Status of Digital 2 when configured as an output

<i>Variable</i>	<i>Description</i>
DigitalOut3	Status of Digital 3 when configured as an output
DigitalOut4	Status of Digital 4 when configured as an output
DigitalIn1	Status of Digital 1 when configured as an input
DigitalIn2	Status of Digital 2 when configured as an input
DigitalIn3	Status of Digital 3 when configured as an input
DigitalIn4	Status of Digital 4 when configured as an input
AnalogIn1	Voltage level of Analog Input 1
AnalogIn2	Voltage level of Analog Input 2
AnalogIn3	Voltage level of Analog Input 3
AnalogIn4	Voltage level of Analog Input 4
Deg C	Temperature reading from C8000
MOhm	Impedance milli-ohm reading from C8000
Thml Chm Status	Indicates the basic condition of the Thermal Chamber. (Hold and Running)
Thml Chm Tmp	The temperature reading from supported thermal chambers

1. From the **Tools** menu, select **BatteryLab Configuration**. The **BatteryLab Configuration** window appears.



2. Click **Results Panel**. The **Results Panel** window appears.



3. To add a field to the **Results** window, select the field in the *Available Fields* column and click **Add**.
4. To remove a field from the **Results** window, select the field in the *Display Fields* window and click **Remove**.



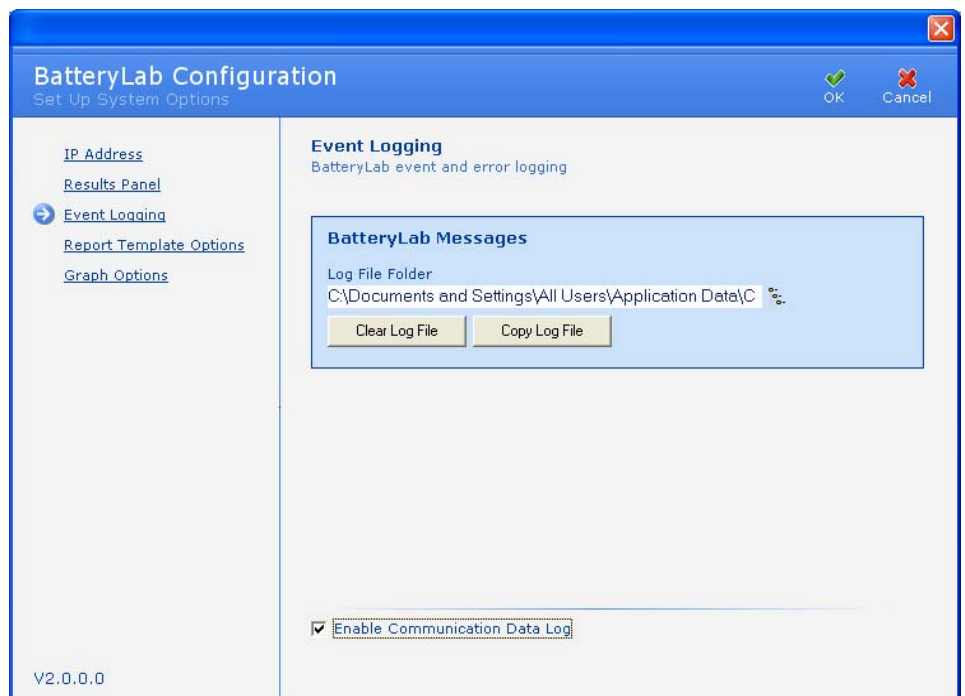
5. To select the order the fields appear in the **Results** window, select the fields in the *Display Fields* column and click **Up** and **Down**. **Note:** The first field listed will appear on the left side of the **Results** panel.
6. Click **OK** to save the field changes.

### 3.2.2 Event Logging

BatteryLab creates log files for events occurring in BatteryLab and for real-time status events in C8000s.

To select the location of the log file and Enable:

1. From the **Tools** menu, select **BatteryLab Configuration**. The **BatteryLab Configuration** window appears. Click **Event Logging**. The **Event Logging** window appears.



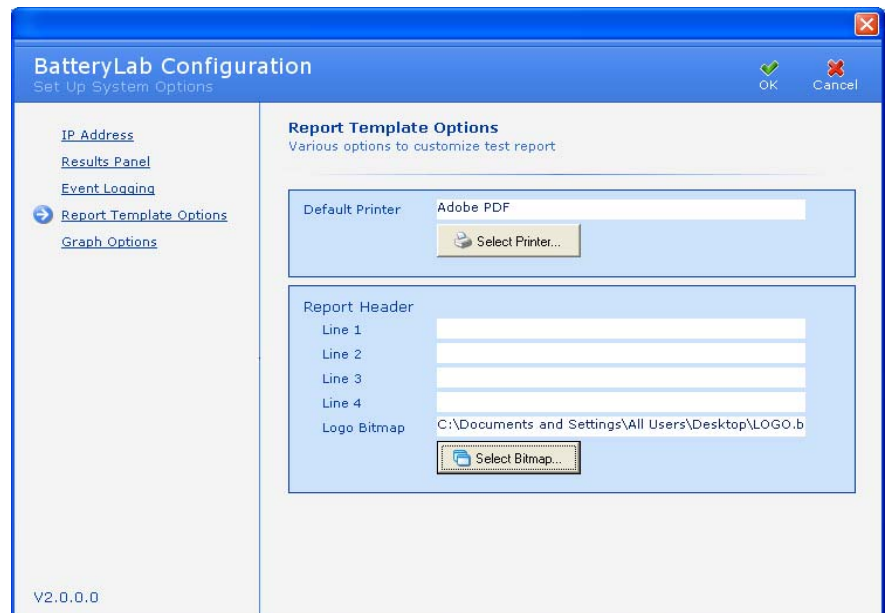
2. Click the **Browse** icon to select the location to store the log file.
3. Click **Clear Log File** to delete the events in the selected log file. By default, the log file is always the same file - only the location can be changed.
4. Click **Copy Log File** to create a back up copy of the selected log file. By default, the backup log file is always the same file - only the location can be changed.

5. Select the *Enable Communication Data Log* check box to log all communications between the C8000 and BatteryLab for debug purposes only. **Note:** Multiple files may be stored in this location if the file size exceeds 100MB. Any additional files will be numerically appended in the order of 1.

### 3.2.3 Report Template Options

BatteryLab test reports can be customized with a logo and report headers.

1. From the **Tools** menu, select **BatteryLab Configuration**. The **BatteryLab Configuration** window appears. Click **Report Template Options**. The **Report Template Options** window appears.

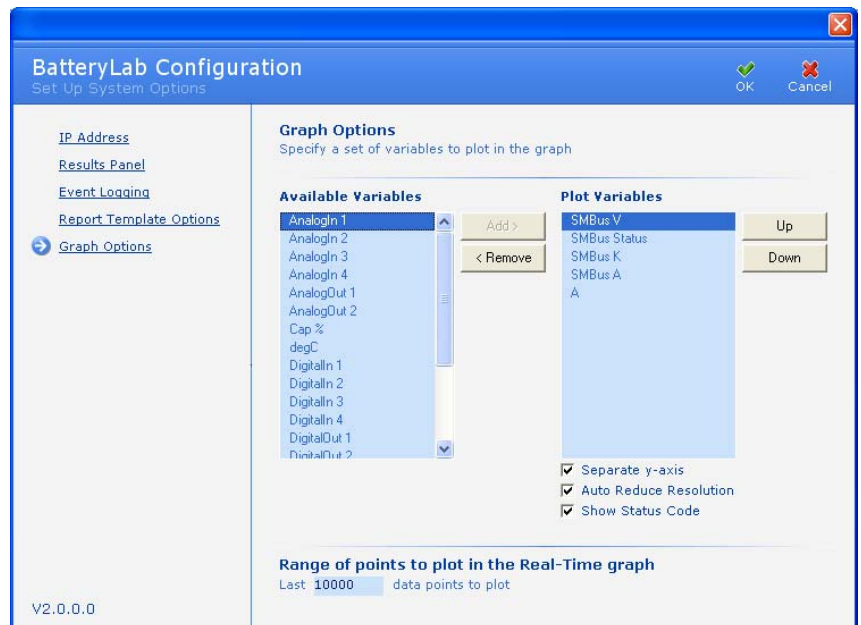


2. Click **Select Printer** to select the default printer for test reports.
3. In the *Lines 1* through *4* fields, type the text that will appear as headers in the test report.
4. Click **Select Bitmap** to select a logo bitmap file. The recommended size for a BMP logo is 1.5 inches x 1.5 inches.
5. Click **OK**.

### 3.2.4 Graph Options

Altering the Plot Variables can customize the default variables for the graphs;

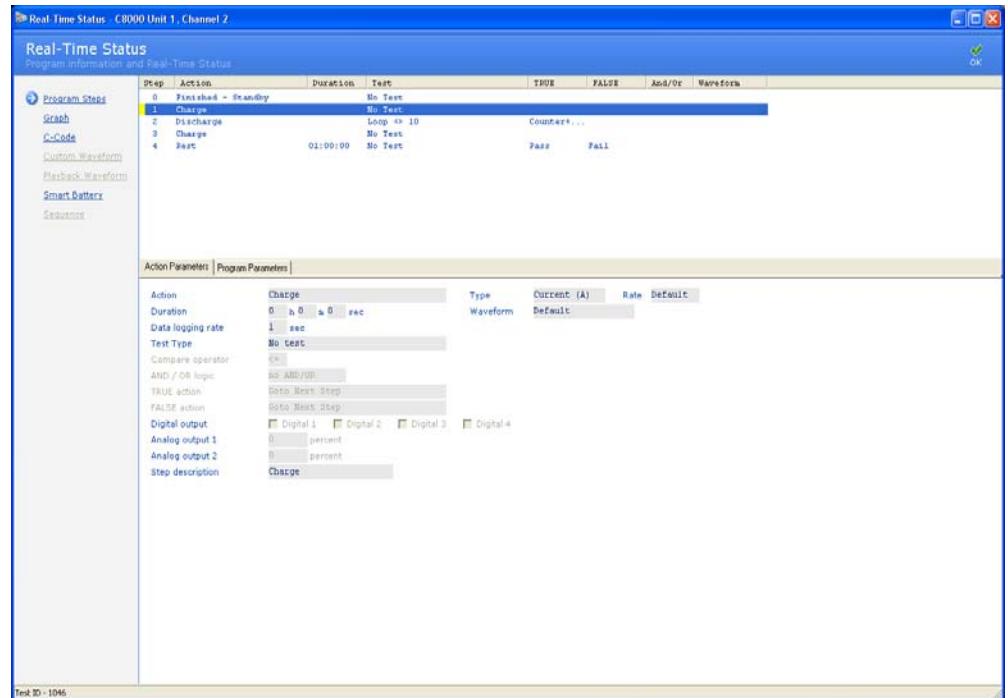
1. From the **Tools** menu, select **BatteryLab Configuration**. The **BatteryLab Configuration** window appears. Click **Graph Options**. The **Graph Options** window appears.



2. To add a variable, select the variable in the *Available Variables* column and click **Add**. **Note**: A maximum of 4 variables can be plotted at anytime.
3. To remove a variable, select the variable in the *Plot Variables* column and click **Remove**.
4. To adjust the order of display for a variable in the plot, select the variable in the *Plot Variables* column and click **Up** or **Down**.
5. To display the separate Y-axis for the selected variables, select the *Separate y-axis* check box.
6. Specify the last range of points to plot (the default is 10000) in the graph in the *Last x available data points* field. **Note**: All Real-time graphs have a maximum of 10000 points.
7. To Display the program's *Status Code* during the service select the check box.
8. *Auto Reduce Resolution* will decimate the graph, reducing the number of points displayed for large graphs over 1000 points, increasing the graph display response. All points are still viewed as the graph is zoomed in.
9. Click **OK**.

### 3.3 View Battery Status in Real-Time

When BatteryLab successfully connects to one or more batteries, select a channel and click the **Real-Time** icon in the **C8000 Result Panel** or right-click the channel, to view the status of a battery. The **Real-Time Status** window appears.

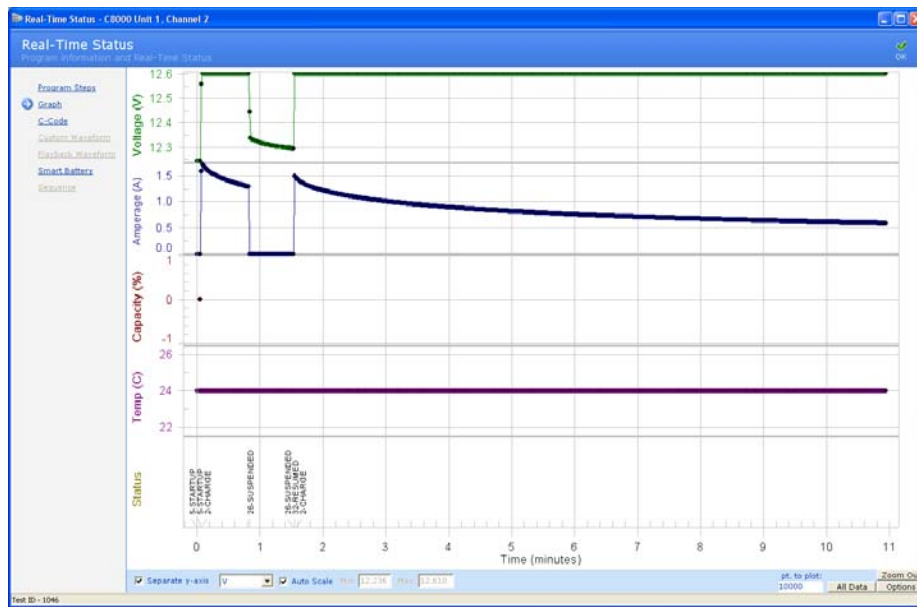


The **Real-Time Status** window defaults to the “program steps” being currently executed for this battery channel.

**Program Step** – shows all the steps within the program being currently run. Selecting a *step* will display all the parameters of the step, within the *Action Parameters* sub-window. The parameters for the entire program can be found in the *Program Parameters* sub-window.

To view a real-time graph for the selected channel, click **Graph**. The **Real-Time Graph** window appears. Note: If the service on the C8000 was started before **BatteryLab** was connected, the graph will not appear. In this case, the message *No Data* appears.

**BatteryLab** will create a service record if the service on the C8000 was started before **BatteryLab** was connected.



**Graph** –displays all the recorded data. The graph can display up to five individual variables, simultaneously.

Located in the bottom right.

**Options** - Allows the selection of the variables to be displayed.

**All Data**- Shows the entire graph. The standard real-time graph is limited to a maximum of 10000 points.

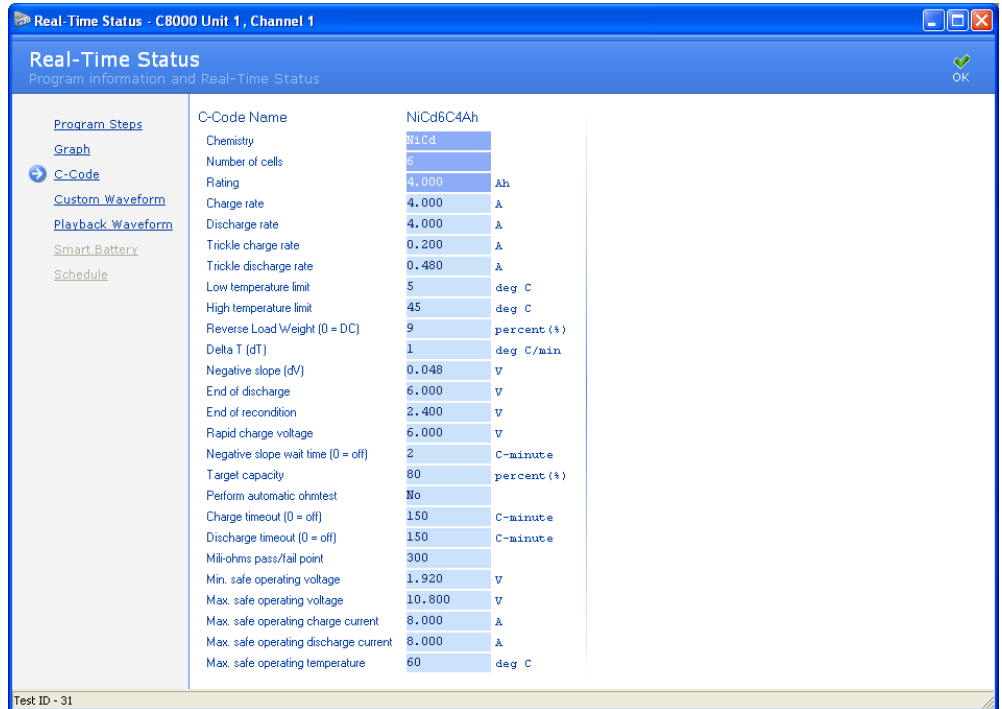
**Zoom Out** – undo all zoom commands.

**Separate y-axis** – Separates all graphs into individual scales. Default checked.

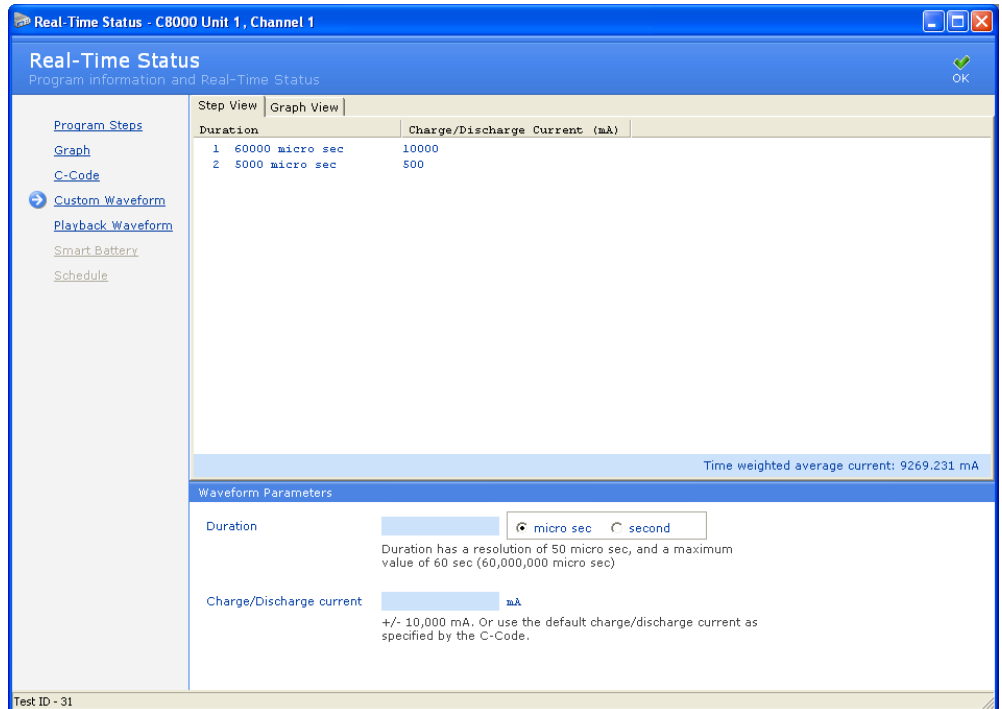
**Auto Scale** – Automatically scales each graph, on the y-axis. To manual scale the y-axis, select the graph (Drop box) to manual scale and uncheck the box. Enter in the range in the “Min” and “Max” boxes and press enter.

To zoom in on an area of the graph select the left mouse button and hold. Drag and hold the mouse cursor until the required area is within the zoom box, release the mouse button.

To view the current C-Code for this channel, click **C-Code**.



To view waveforms for this channel, click **Custom Waveform**. The Waveforms real-time information appears.



To view the playback of a waveform, click **Playback Waveform**. The **Playback Waveform** window appears.

To view smart battery real-time information, click **Smart Battery**.

The screenshot shows the 'Real-Time Status' window for 'C8000 Unit 1, Channel 2'. The window title is 'Real-Time Status - C8000 Unit 1, Channel 2'. The main content area is divided into two columns. The left column lists various battery parameters with their current values and units. The right column lists specification information with their values. A sidebar on the left contains navigation links: Program Steps, Graph, C-Code, Custom Waveform, Playback Waveform, Smart Battery (selected), and Sequence. At the bottom, there are buttons for Refresh, Export SM-Bus Data, and Print SM-Bus Data. The test ID is 1046.

Parameter	Value	Unit
Remaining Capacity Alarm	0.780	Ah
Remaining Time Alarm	10	minutes
Battery Mode	0	
At Rate	0.000	A
At Rate Time to Full	65535	minutes
At Rate Time to Empty	65535	minutes
At Rate OK	Yes	Yes/No
Temperature	29.95	deg C
Voltage	10.974	Volt
Current	-3.751	A
Average Current	-3.751	A
Max Error	0	percent
Relative State of Charge	87	percent
Absolute State of Charge	48	percent
Remaining Capacity	3.724	Ah
Full Charge Capacity	4.300	Ah
Run Time to Empty	60	minutes
Average Time to Empty	60	minutes
Average Time to Full	65535	minutes
Charging Current	3.750	A
Charging Voltage	12.600	Volt
Battery Status	0x00C0	
Cycle Count	23	count
Design Capacity	7.800	Ah
Design Voltage	10.800	Volt

Specification Info	Value
Specification Info	0x0031
Manufacturer Date	2006/10/11 y/m/d
Serial Number	29072
Manufacturer Name	DF-SDI26
Device Name	OPDS
Device Chemistry	LIION

To view the schedule of programs for this channel, click **Schedule**. The **Schedule** window displays the program steps that were executed.

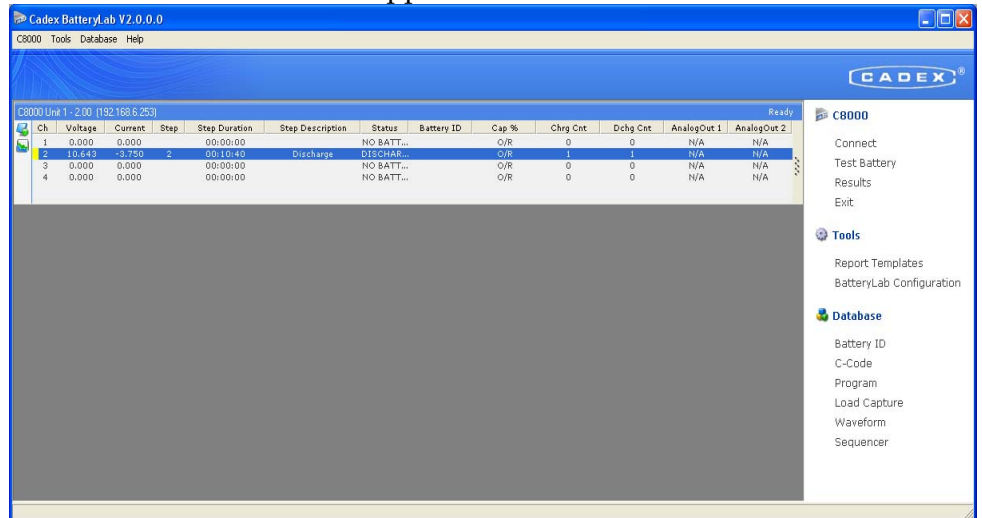
The screenshot shows the 'Real-Time Status' window for 'C8000 Unit 1, Channel 1'. The window title is 'Real-Time Status - C8000 Unit 1, Channel 1'. The main content area displays a table of program steps. The sidebar on the left contains navigation links: Program Steps, Graph, C-Code, Custom Waveform, Playback Waveform, Smart Battery, and Schedule (selected). At the bottom, there are buttons for Refresh, Export SM-Bus Data, and Print SM-Bus Data. The test ID is 32.

Test ID	Program	C-Code	Battery ID
32	TrickleCharge_5s	SLA_12-7	
	DchgOnly	SLA_12-7	

## 3.4 Test Batteries with BatteryLab

To test a battery:

1. From the **BatteryLab Main** menu, click **Connect**.  
The **C8000** window appears.

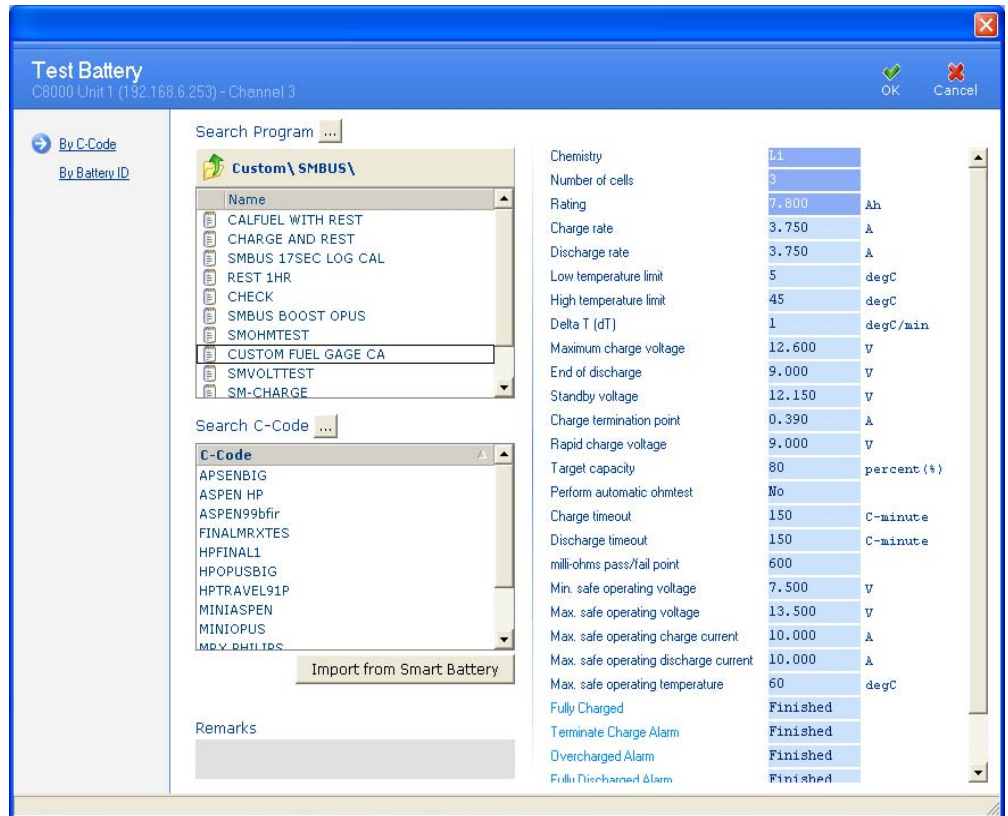


BatteryLab waits for C8000s to connect. When a C8000 connects to BatteryLab, the C8000 window title updates to reflect the IP Address of the connected C8000. The C8000 also updates its Title Header from *C8000* to the *Unit #* indicated on the analyzer window. Wait for the C8000 to connect to BatteryLab before starting to test a battery.

If the C8000 and software do not connect within 15 to 60 seconds, check the IP addresses and verify that no IP address is duplicated on the network. (An error message appears if the time-out limit is reached.) Recycle power on the C8000, and restart BatteryLab. If problems persist, see [Communication Issues](#).

1. Select a C8000, choose a channel, select and right-click on the channel and choose **Test Battery**. The **Test Battery** window appears.



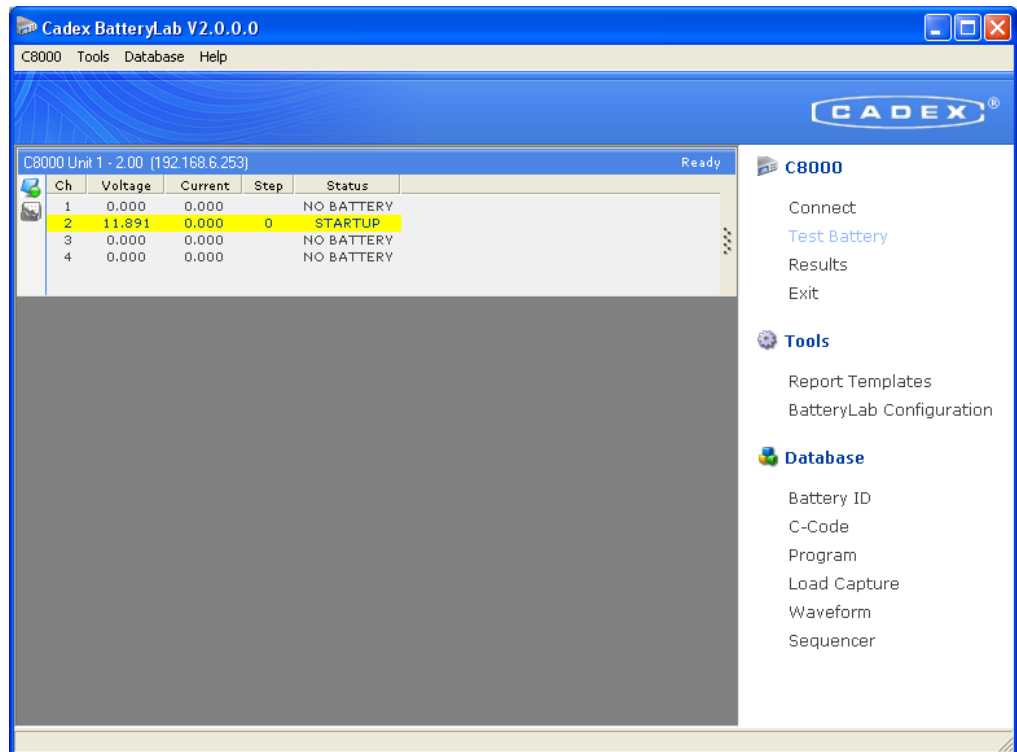


2. Enter the following information.
  - **Program:** Select a program.
    - There are two type of programs available (SM-BUS and STANDARD)
  - **C-Code or Battery ID:** Enter the battery ID or c-code.
    - The type of program selected will filter the available C-codes. **Example:** SM-BUS program will only filter all non-SM-BUS C-codes from the available list.
    - To automatically create a SM-BUS C-code, select **Import from Smart Battery**. See section [3.9.2 Add a SM-BUS \(Smart Battery\) C-Code](#) for details.
3. Click **OK**.
4. Connect correct battery channel terminals on C8000 to battery. The prompt clears automatically when the test starts.

### 3.4.1 View the Status of a Test in BatteryLab

The C8000 window in Battery Lab displays the status of each test running on the C8000:

- Channel
- Volts
- Current
- Program step
- Status message



To modify the information that appears in the **Result Panel**, select **Result Panel** in the **BatteryLab Configuration** window.

#### 3.4.1.1 Background Color of Tests Running

The background color displayed for each test running indicates the status of the test.

<b>Status Color</b>	<b>Description</b>
No Color Change	Status unchanged
White	No battery
Red with Status Code in White	Fail
White with text in Red	Unknown Error -Fail
Yellow	Service Running

Yellow with text in Red	Warning
Green	Pass

---

## 3.4.2 Cancel or Suspend a Test in BatteryLab

You can cancel a running test; suspend a test that is running, or resume a suspended test.

### 3.4.2.1 Cancel a Test

In the C8000 window, right-click the channel of the C8000 **Result Panel** and choose **Abort**.

### 3.4.2.2 Suspend a Test

In the C8000 window, right-click on the channel and choose **Suspend**.

### 3.4.2.3 Resume a Suspended Test

In the C8000 window, right-click on the channel and choose **Resume**.

### 3.4.2.4 Simulate a Battery Removal

In the C8000 window, right-click on the channel and choose **Remove Battery**.

---

## 3.4.3 Retrieve Test Results from the C8000

Test results are automatically retrieved from the C8000s as long as BatteryLab is online and the C8000 is connected. When a test is started, BatteryLab immediately retrieves the test results. Tests started on the C8000 must be manually retrieved using the **Test Results** window in BatteryLab.

1. From the **C8000** menu, select **Results**. The **Test Results** window appears.

Test ID	Test Date	Battery ID	C Code	Program	Full Message	Events	Result	Channel	Sequence	Sequence History ID
291	16/02/2018 11:44:21 AM	SMDUC		FullChargeCalibrate	1.9%	N/C		1		0
292	16/02/2018 11:46:56 AM	SMDUC		FullChargeCalibrate	1.9%	N/C		1		0
293	16/02/2018 11:50:45 AM	SMDUC		FullChargeCalibrate	1.9%	N/C		1		0
294	16/02/2018 7:46:26 AM	SMDUC		SMD Chrg	1.9%	N/C		1		0
295	16/02/2018 7:46:10 AM	HP TRAVEL		Auto	1.9%	N/C		1		0
296	15/02/2018 2:37:57 PM	HP TRAVEL		Swch DIS CHARGE	1.9%	N/C		1		0
297	15/02/2018 2:38:16 AM	BLUE TOP		1A 2A pulse	1.9%	N/C		1		0
298	15/02/2018 11:57:42 AM	BLUE TOP		CHARGE 1 SEC LOG	1.9%	N/C		1		0
299	15/02/2018 10:42:08 AM	BLUE TOP		1A 2A pulse	1.9%	N/C		1		0
300	15/02/2018 10:40:05 AM	BLUE TOP		1A 2A pulse	1.9%	N/C		1		0
301	15/02/2018 10:40:58 AM	BLUE TOP		1A 2A pulse	1.9%	N/C		1		0
302	15/02/2018 9:28:26 AM	HP TRAVEL		FAST AUTO LOG	1.9%	N/C		1		0
303	15/02/2018 9:28:14 AM	BLUE TOP		1A 2A pulse	1.9%	N/C		2		0
304	15/02/2018 9:28:04 AM	BLUE TOP		1A 2A pulse	1.9%	N/C		2		0
305	15/02/2018 9:13:08 AM	BLUE TOP		1A 2A pulse	1.9%	N/C		4		0
306	15/02/2018 8:42:42 AM	HP TRAVEL		FAST LOG DISCHARGE	1.9%	N/C		1		0
307	15/02/2018 8:27:39 AM	BLUE TOPFN		Hwu Charge	1.9%	N/C		4	BLUE TOP	27
308	15/02/2018 8:22:23 AM	HP TRAVEL		FAST AUTO LOG	1.9%	N/C		1		0
309	14/02/2018 9:02:39 PM	BLUE TOP		DIS CHARGE	1.9%	N/C		1		0
310	14/02/2018 4:41:10 PM	BLUE TOP		REST 30MINUTES	1.9%	N/C		4	BLUE TOP	27
311	14/02/2018 2:33:37 PM	BLUE TOPFN		Hwu Charge	1.9%	N/C		4	BLUE TOP	27
312	14/02/2018 12:32:16 AM	BLUE TOP		DIS CHARGE	1.9%	N/C		4	BLUE TOP	27
313	14/02/2018 12:11:28 AM	BLUE TOPFN		REST 30MINUTES	1.9%	N/C		4	BLUE TOP	27
314	13/02/2018 11:28:07 PM	BLUE TOPFN		Hwu Charge	1.9%	N/C		4	BLUE TOP	27
315	13/02/2018 10:25:56 PM	BLUE TOPFN		Hwu Charge	1.9%	N/C		2	BLUE TOP	26
316	13/02/2018 4:52:56 PM	BLUE TOPFN		Hwu Charge	1.9%	N/C		3	BLUE TOP	26
317	13/02/2018 12:41:02 PM	BLUE TOP		DIS CHARGE	1.9%	N/C		2	BLUE TOP	25
318	13/02/2018 12:20:47 PM	BLUE TOP		REST 30MINUTES	1.9%	N/C		2	BLUE TOP	25
319	13/02/2018 11:20:25 AM	BLUE TOPFN		Hwu Charge	1.9%	N/C		2	BLUE TOP	25
320	13/02/2018 9:50:20 AM	BLUE TOP		DIS CHARGE	1.9%	N/C		3	BLUE TOP	26
321	13/02/2018 9:36:50 AM	BLUE TOP		REST 30MINUTES	1.9%	N/C		3	BLUE TOP	26
322	13/02/2018 9:07:17 AM	BLUE TOPFN		Hwu Charge	1.9%	N/C		1	BLUE TOP	24
323	13/02/2018 8:39:19 AM	BLUE TOPFN		Hwu Charge	1.9%	N/C		1	BLUE TOP	24
324	13/02/2018 8:00:56 AM	BLUE TOP		DIS CHARGE	1.9%	N/C		4	BLUE TOP	27
325	13/02/2018 7:20:19 AM	BLUE TOP		REST 30MINUTES	1.9%	N/C		4	BLUE TOP	27
326	13/02/2018 6:27:46 AM	BLUE TOPFN		Hwu Charge	1.9%	N/C		4	BLUE TOP	27
327	13/02/2018 4:11:59 AM	BLUE TOP		DIS CHARGE	1.9%	N/C		1	BLUE TOP	24
328	13/02/2018 3:50:43 AM	BLUE TOP		REST 30MINUTES	1.9%	N/C		1	BLUE TOP	24
329	13/02/2018 2:51:15 AM	BLUE TOPFN		Hwu Charge	1.9%	N/C		1	BLUE TOP	24
330	13/02/2018 2:47:02 AM	BLUE TOP		DIS CHARGE	1.9%	N/C		2	BLUE TOP	25
331	13/02/2018 2:33:16 AM	BLUE TOP		DIS CHARGE	1.9%	N/C		3	BLUE TOP	26
332	13/02/2018 2:27:26 AM	BLUE TOP		REST 30MINUTES	1.9%	N/C		2	BLUE TOP	25
333	13/02/2018 2:14:46 AM	BLUE TOP		REST 30MINUTES	1.9%	N/C		3	BLUE TOP	26
334	13/02/2018 1:26:11 AM	BLUE TOPFN		Hwu Charge	1.9%	N/C		2	BLUE TOP	25

{XE "test: results download results to BatteryLab"} {XE "BatteryLab: download test results from C8000"}

- The **Test Results** window lists the 100 most recent test results in the database. Click **Search** to view all test results in the database
- To retrieve test results for battery tests started on the C8000, select **Retrieve Results** from the **File** menu.

The *Result* column indicates the test result, for example Pass or Fail. A test result of N/A means the test result file was not found; a test result of N/C means the test was not completed as it is still running.

Note: If results for tests NOT started via BatteryLab are retrieved long after Test Results on the C8000 are automatically deleted, then there is a chance that the wrong Test Result record will become associated with Test Records in the BatteryLab database. For this reason, it is recommended that the *Retrieve Results* should occur before associated Test Results on the C8000 are automatically deleted.

## 3.5 Test Status

The test results list shows status codes to indicate the status of the battery test.

- Open the test result you want to view.  
For information on viewing the test results, see [View Test Results in BatteryLab](#).

2. In the test results, note the information in the **Results** and **Status Code** fields.
3. Look up the status code in the [Status Messages Listed by Code](#) and [Status Messages Listed by Detailed Message](#) sections of this manual.
4. Take the appropriate actions based on the information in the table.

### 3.6 View Test Results in BatteryLab

Tests started with BatteryLab are automatically retrieved from the C8000 when the test completes and BatteryLab is still running.

If a test is started on a C8000 and BatteryLab is not running, the Test Results will be saved on the C8000. When BatteryLab is run the next time, use the **Retrieve Results (File)** menu option on the **Test Results** window to retrieve the results for the test started on the C8000. However, in this case, test results will not include graph data.

Date	C-Code	Program	Channel	Test Result File	Result	
06/06/2010 1:27:30 PM	TESTOPUS	CUSTOM FUEL GAGE CA	2	C2.001.tst	FAIL	
1045	21/06/2010 5:31:21 PM	HPDOPUSBIG	FuelGaugeCalibrate	2	C2.036.tst	FAIL
1044	14/06/2010 5:39:48 PM	OPUSBIG998F	CUSTOM FUEL GAGE CA	2	C2.035.tst	FAIL
1043	14/06/2010 5:30:35 PM	OPUSBIG998F	CUSTOM FUEL GAGE CA	2	C2.034.tst	FAIL
1042	14/06/2010 5:30:06 PM	ASPEN998br	CUSTOM FUEL GAGE CA	4	C4.005.tst	FAIL
1041	14/06/2010 4:33:44 PM	OPUSBIG998F	CUSTOM FUEL GAGE CA	2	C2.033.tst	FAIL
1040	14/06/2010 4:06:28 PM	OPUSBIG998F	CUSTOM FUEL GAGE CA	2	C2.032.tst	FAIL
1039	14/06/2010 4:04:48 PM	ASPEN998br	CUSTOM FUEL GAGE CA	4	C4.004.tst	FAIL
1038	14/06/2010 4:03:47 PM	HPFINAL1	CUSTOM FUEL GAGE CA	3	C3.004.tst	FAIL
1037	11/06/2010 3:31:34 PM	APSENBIG	CUSTOM FUEL GAGE CA	4	C4.003.tst	FAIL
1036	11/06/2010 3:29:47 PM	HPFINAL1	CUSTOM FUEL GAGE CA	3	C3.003.tst	FAIL
1035	11/06/2010 3:28:14 PM	MINIOPUS	CUSTOM FUEL GAGE CA	2	C2.031.tst	PASS
1034	11/06/2010 3:27:49 PM	MRX PHILIPS	CUSTOM FUEL GAGE CA	1	C1.028.tst	FAIL
1033	09/06/2010 1:28:56 PM	MINIOPUS	CUSTOM FUEL GAGE CA	2	C2.011.tst	FAIL
1032	07/06/2010 5:19:58 PM	MRX PHILIPS	CUSTOM FUEL GAGE CA	1	C1.009.tst	PASS
1031	07/06/2010 2:28:44 PM	MINIOPUS	CUSTOM FUEL GAGE CA	2	C2.010.tst	FAIL
1030	07/06/2010 2:05:34 PM	MINIOPUS	CUSTOM FUEL GAGE CA	2	C2.009.tst	FAIL
1029	07/06/2010 2:04:36 PM	APSENBIG	CUSTOM FUEL GAGE CA	1	C1.008.tst	FAIL
1028	04/06/2010 3:36:51 PM	APSENBIG	CUSTOM FUEL GAGE CA	1	C1.007.tst	FAIL
1027	04/06/2010 1:17:42 PM	1SLA	THERM2THERMBRANCHE	1	C1.004.tst	PASS
1026	04/06/2010 1:15:18 PM	1SLA	THERMALBRANCH	1	C1.003.tst	FAIL
1025	04/06/2010 1:15:55 PM	APSENBIG	CUSTOM FUEL GAGE CA	1	C1.006.tst	FAIL
1024	04/06/2010 10:37:27 AM	MINIOPUS	CUSTOM FUEL GAGE CA	2	C2.008.tst	FAIL
1023	04/06/2010 10:35:30 AM	hpopus	Boost	2	C2.007.tst	FAIL
1022	04/06/2010 9:14:21 AM	APSENBIG	CUSTOM FUEL GAGE CA	1	C1.005.tst	FAIL
1021	04/06/2010 8:32:08 AM	ASPEN HP	CUSTOM FUEL GAGE CA	1	C1.004.tst	FAIL
1020	04/06/2010 8:30:26 AM	HPDOPUSBIG	CUSTOM FUEL GAGE CA	2	C2.006.tst	FAIL

1. From the **C8000** menu, click Results. The **Test Results** window appears.
2. In the *Search for* field, type part or all of the battery ID or C-Code.
3. Select the *All Dates* check box to find all test results for the battery.

--or--

Clear the *All Dates* check box and select the date range to view.

4. Click **Search**. The results appear in the window.

### 3.6.1 Import Test Results

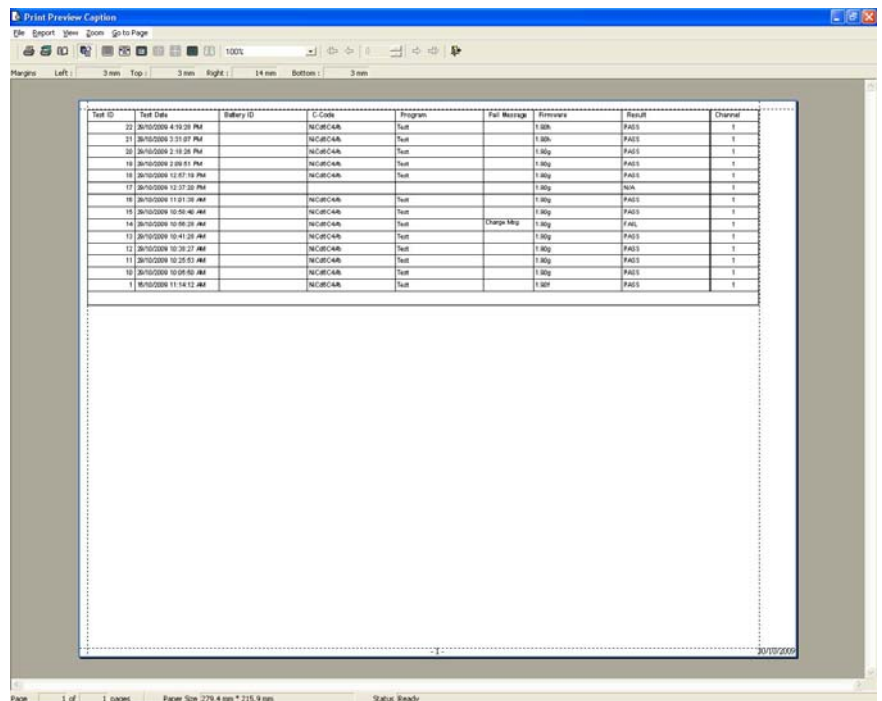
To import test results from a file:

1. From the **C8000** menu, click **Results**. The **Test Results** window appears.
2. From the **File** menu, select **Import Test Results**. The **Open** window appears.
3. Select the file that contains the test results to import and click **Open**.

### 3.6.2 Print a Search List

To print the search list:

1. From the **C8000** menu, click **Results**. The **Test Results** window appears.
2. From the **File** menu, select **Print Search List**. The **Print Preview Caption** window appears.



The screenshot shows a 'Print Preview Caption' window with a table of test results. The table has the following columns: Test ID, Test Date, Battery ID, C-Date, Program, Fail Message, Comments, Result, and Channel. The data is as follows:

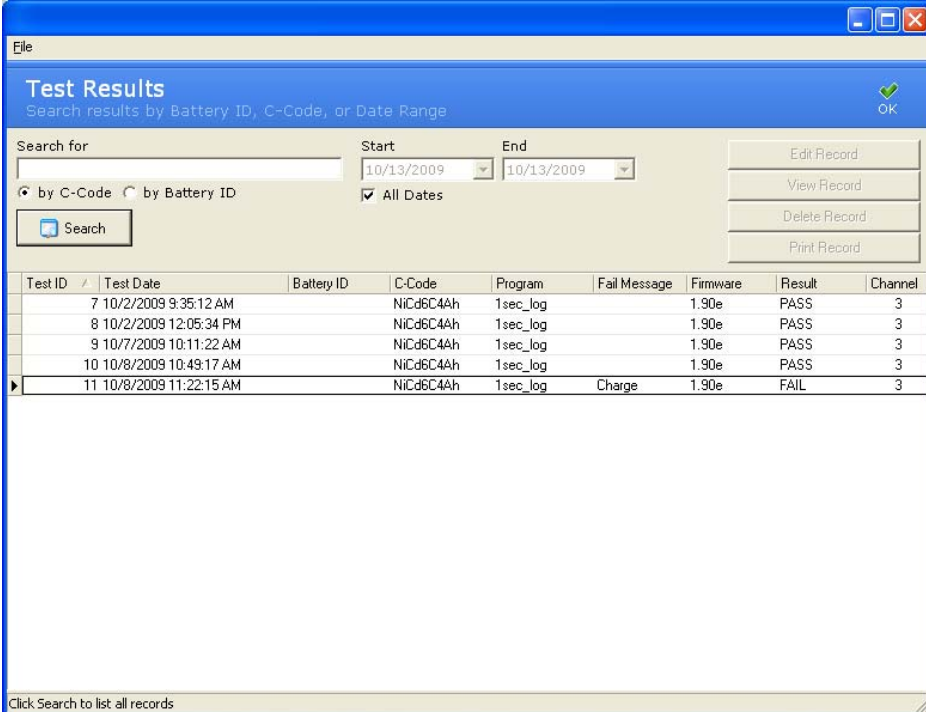
Test ID	Test Date	Battery ID	C-Date	Program	Fail Message	Comments	Result	Channel
22	26/10/2009 4:19:29 PM		NCRCAL	Test		1.80%	PASS	1
21	26/10/2009 3:31:07 PM		NCRCAL	Test		1.80%	PASS	1
20	26/10/2009 2:18:26 PM		NCRCAL	Test		1.80%	PASS	1
19	26/10/2009 2:08:51 PM		NCRCAL	Test		1.80%	PASS	1
18	26/10/2009 12:07:10 PM		NCRCAL	Test		1.80%	PASS	1
17	26/10/2009 12:07:20 PM		NCRCAL	Test		1.80%	N/A	1
16	26/10/2009 11:01:36 AM		NCRCAL	Test		1.80%	PASS	1
15	26/10/2009 10:50:46 AM		NCRCAL	Test		1.80%	PASS	1
14	26/10/2009 10:46:35 AM		NCRCAL	Test	Charge Mfg	1.80%	FAIL	1
13	26/10/2009 10:41:20 AM		NCRCAL	Test		1.80%	PASS	1
12	26/10/2009 10:38:27 AM		NCRCAL	Test		1.80%	PASS	1
11	26/10/2009 10:28:51 AM		NCRCAL	Test		1.80%	PASS	1
10	26/10/2009 10:09:50 AM		NCRCAL	Test		1.80%	PASS	1
9	26/10/2009 11:14:12 AM		NCRCAL	Test		1.80%	PASS	1

3. From the **Report** menu, click **Print** to print the search list report.

### 3.6.3 View and Print Test Details

View detailed battery test information by selecting a record in the **Test Result** list and clicking **View Record**.

1. From the **C8000** menu, click **Results**. The **Test Results** window appears with 100 of the latest results listed. Click **Search** to view all Test Results.

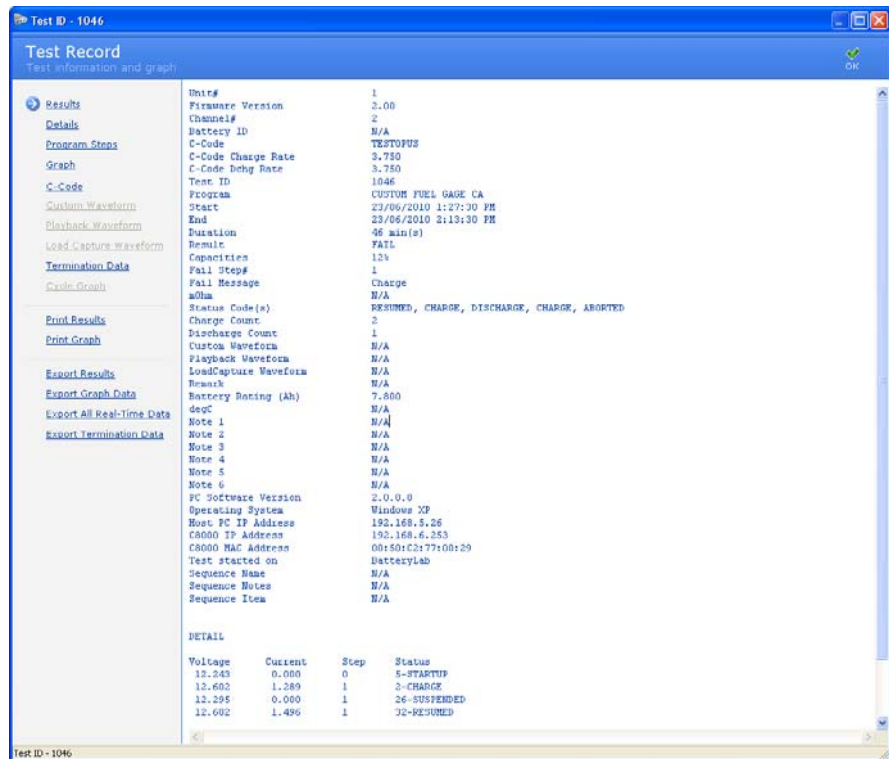


The screenshot shows the 'Test Results' window with a search interface and a table of test records. The search interface includes a 'Search for' field, 'Start' and 'End' date pickers (both set to 10/13/2009), radio buttons for 'by C-Code' (selected) and 'by Battery ID', a 'Search' button, and a checked 'All Dates' checkbox. On the right side, there are buttons for 'Edit Record', 'View Record', 'Delete Record', and 'Print Record'. The table below has columns for Test ID, Test Date, Battery ID, C-Code, Program, Fail Message, Firmware, Result, and Channel.

Test ID	Test Date	Battery ID	C-Code	Program	Fail Message	Firmware	Result	Channel
7	10/2/2009 9:35:12 AM		NiCd6C4Ah	1sec_log		1.90e	PASS	3
8	10/2/2009 12:05:34 PM		NiCd6C4Ah	1sec_log		1.90e	PASS	3
9	10/7/2009 10:11:22 AM		NiCd6C4Ah	1sec_log		1.90e	PASS	3
10	10/8/2009 10:49:17 AM		NiCd6C4Ah	1sec_log		1.90e	PASS	3
11	10/8/2009 11:22:15 AM		NiCd6C4Ah	1sec_log	Charge	1.90e	FAIL	3

Click Search to list all records

2. Select a record from the list.
3. Click **View Record**. The **Test Record** window appears.



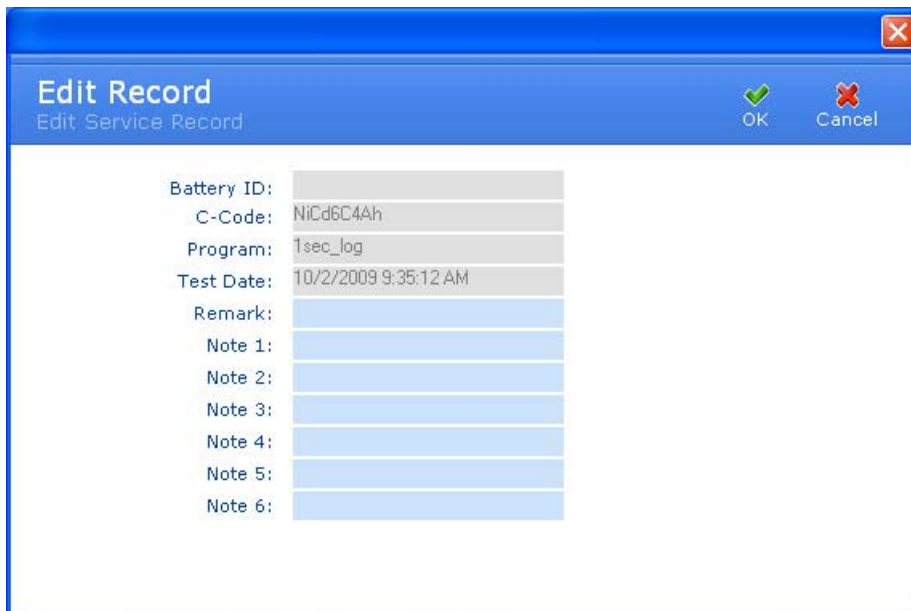
### 3.6.3.1 Edit a Test Result Record

To edit the remarks for a test result:

1. From the C8000 menu, click **Results**. The **Test Results** window appears.
2. In the **Test Results** window, search for the test result by a battery ID or C-Code and click **Search**.
3. Select a result record.



4. Click **Edit Record**. The **Edit Record** window appears.

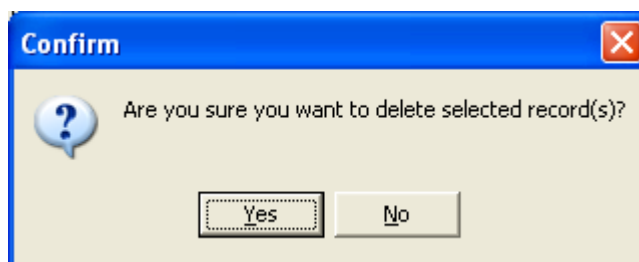


5. Edit the remarks for the test record, as needed.
6. Click **OK**.

### 3.6.3.2 Delete a Battery Test Record

If a battery test record is no longer needed, delete it from the database.

1. From the **C8000** menu, click **Results**. The **Test Results** window appears.
2. In the **Test Results** window, search for the test result by battery ID or C-Code and click **Search**.
3. Select the test record to delete. Hold the CTRL key down to select multiple records.
4. Click **Delete Record**. The **Confirm** window appears.



5. Click **Yes**.

### 3.6.3.3 Print Test Result Document

To print a test result document:

- In the **Test Record** window, click **Print Record**.

### 3.6.3.4 View Details

To the Details:

1. In the **Test Record** window, click **Details**.

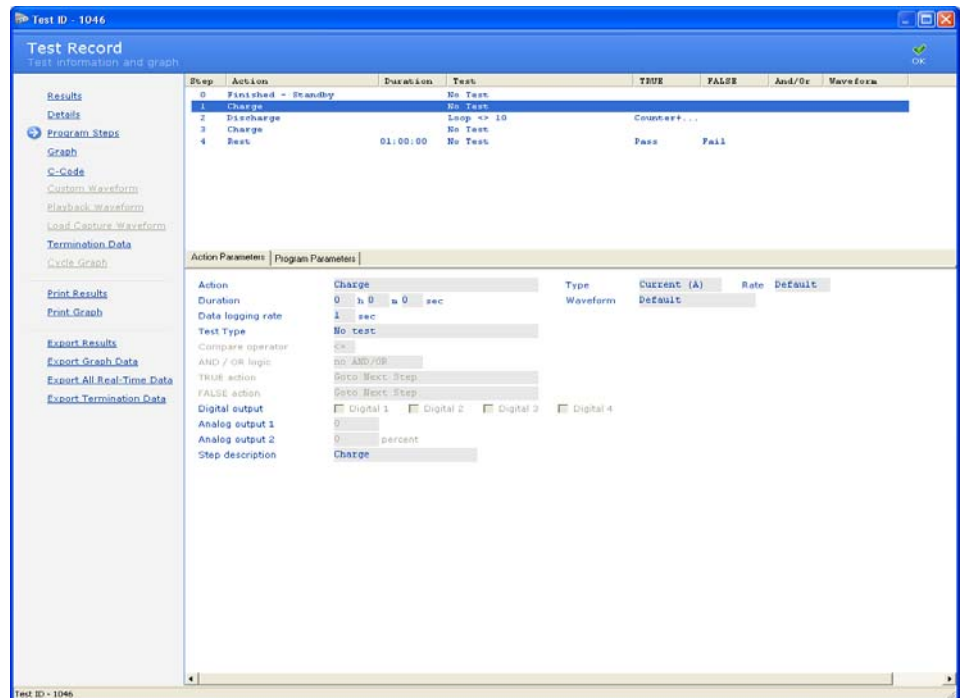
	Voltage	Current	Step	Status
0	12.243	0.000	0	S-STARTUP
1	12.243	0.000	0	S-STARTUP
2	12.559	1.588	1	2-CHARGE
3	12.602	1.714	1	2-CHARGE
4	12.602	1.686	1	2-CHARGE
5	12.603	1.661	1	2-CHARGE
6	12.602	1.641	1	2-CHARGE
7	12.603	1.621	1	2-CHARGE
8	12.602	1.605	1	2-CHARGE
9	12.602	1.589	1	2-CHARGE
10	12.603	1.576	1	2-CHARGE
11	12.602	1.564	1	2-CHARGE
12	12.602	1.551	1	2-CHARGE
13	12.602	1.538	1	2-CHARGE
14	12.603	1.527	1	2-CHARGE
15	12.603	1.516	1	2-CHARGE
16	12.603	1.506	1	2-CHARGE
17	12.603	1.497	1	2-CHARGE
18	12.603	1.486	1	2-CHARGE
19	12.603	1.477	1	2-CHARGE
20	12.602	1.468	1	2-CHARGE
21	12.603	1.459	1	2-CHARGE
22	12.603	1.451	1	2-CHARGE
23	12.603	1.442	1	2-CHARGE
24	12.602	1.435	1	2-CHARGE
25	12.602	1.426	1	2-CHARGE
26	12.602	1.419	1	2-CHARGE
27	12.602	1.411	1	2-CHARGE
28	12.602	1.405	1	2-CHARGE
29	12.603	1.397	1	2-CHARGE
30	12.602	1.390	1	2-CHARGE
31	12.602	1.382	1	2-CHARGE
32	12.603	1.376	1	2-CHARGE
33	12.602	1.369	1	2-CHARGE
34	12.603	1.363	1	2-CHARGE
35	12.602	1.357	1	2-CHARGE
36	12.602	1.350	1	2-CHARGE
37	12.602	1.345	1	2-CHARGE
38	12.603	1.339	1	2-CHARGE
39	12.602	1.332	1	2-CHARGE
40	12.602	1.327	1	2-CHARGE
41	12.602	1.321	1	2-CHARGE
42	12.603	1.315	1	2-CHARGE

2. The **Details** window displays a list of all the recorded data.

### 3.6.3.5 View Program Steps

To view program steps:

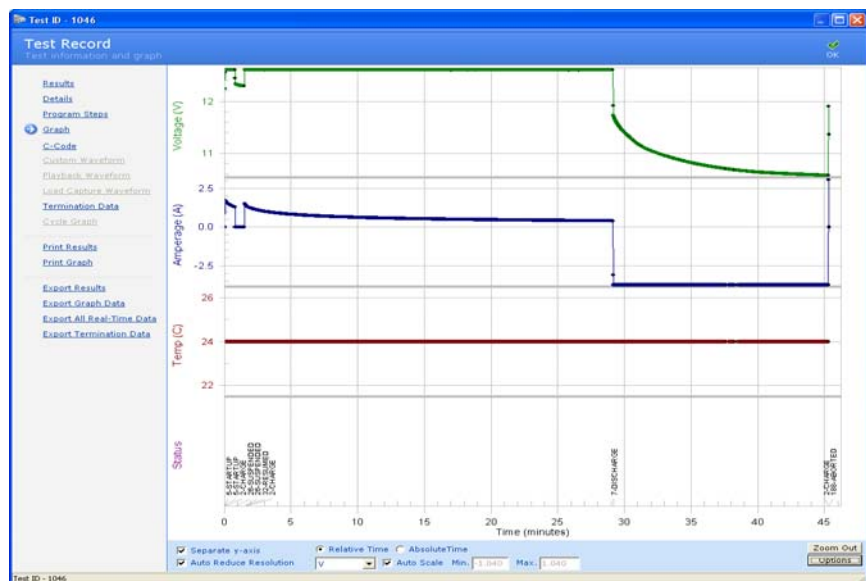
1. In the **Test Record** window, click **Program Steps**.



2. The **Program Steps** window displays each program step and the step's parameters.

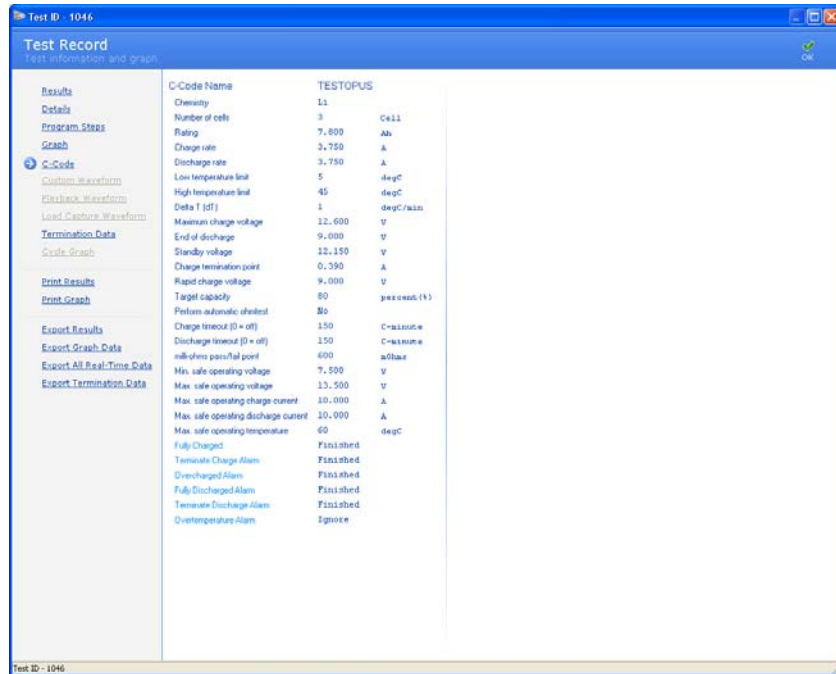
### 3.6.3.6 View a Battery Test Graph

To view a graph of the battery test, click **Graph** in the **Test Record** window.



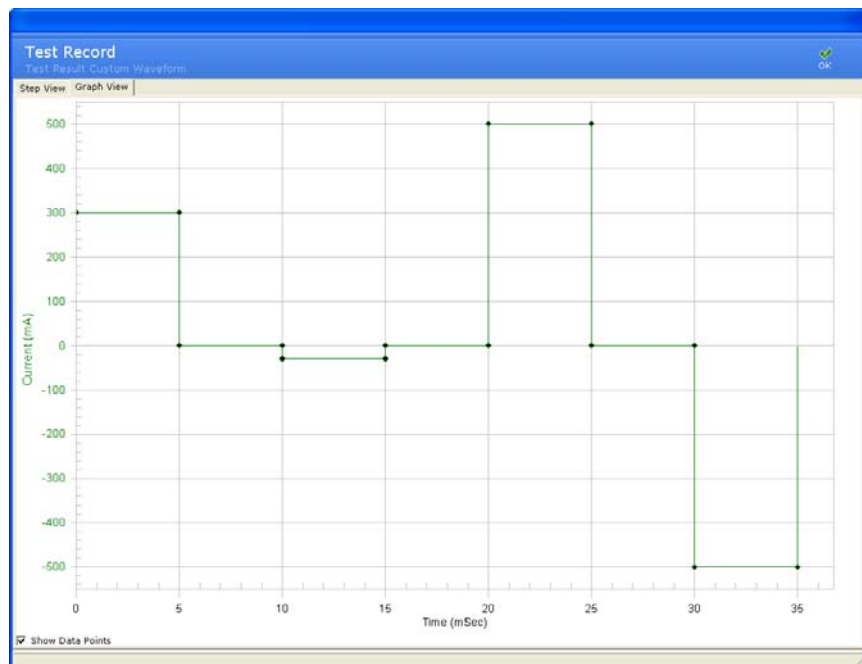
### 3.6.3.7 View C-Code Information

To view C-Code information, click **C-Code** in the **Test Record** window.



### 3.6.3.8 Custom Waveform

To view custom waveform information, click **Custom Waveform** in the **Test Record** window. **Note:** If no Custom Waveform was used in the program, this option will be grayed out.

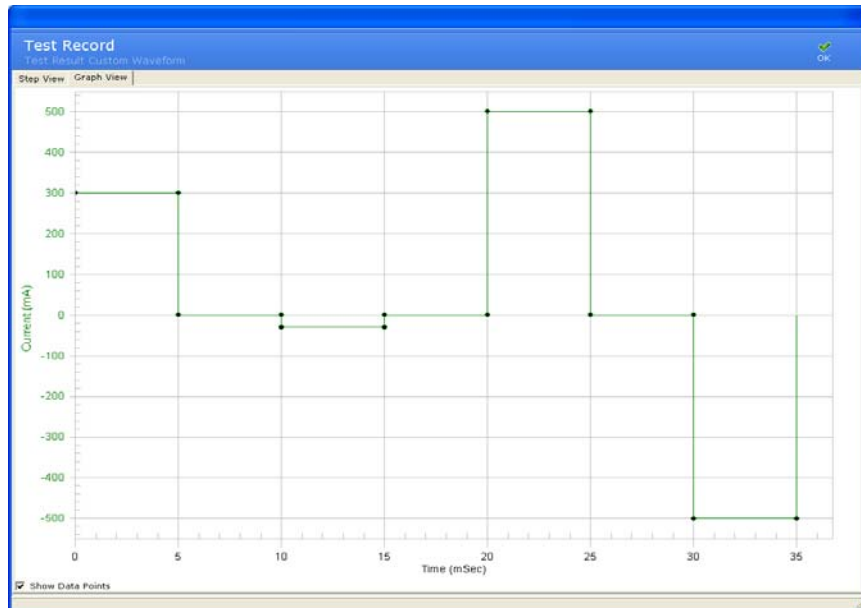


### 3.6.3.9 Playback a Waveform

To playback a waveform:

In the **Test Record** window, click **Playback Waveform**.

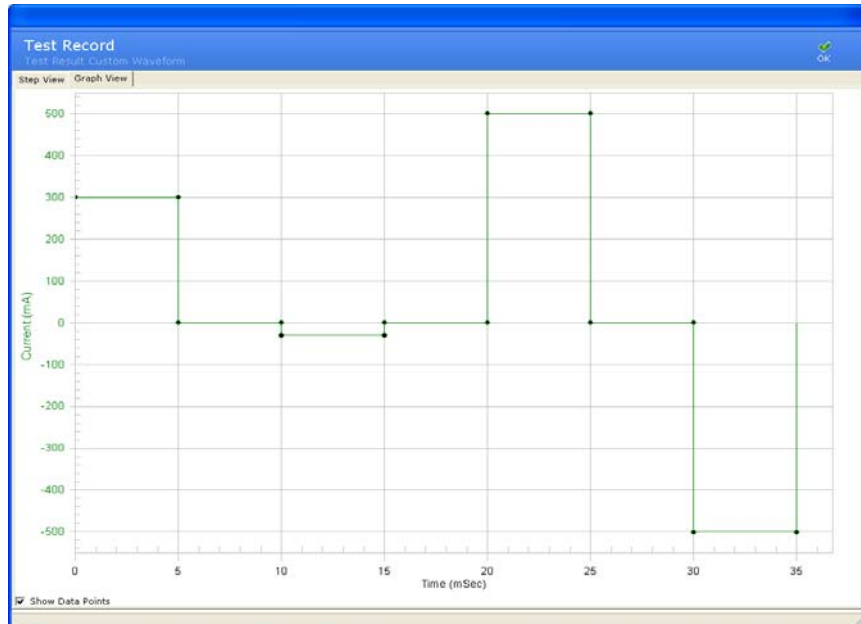
**Note:** If no Playback Waveform was used in the program, this option will be grayed out.



### 3.6.3.10 Load Capture Waveform

To view a load capture waveform in the **Test Record** window, click **Load Capture Waveform**.

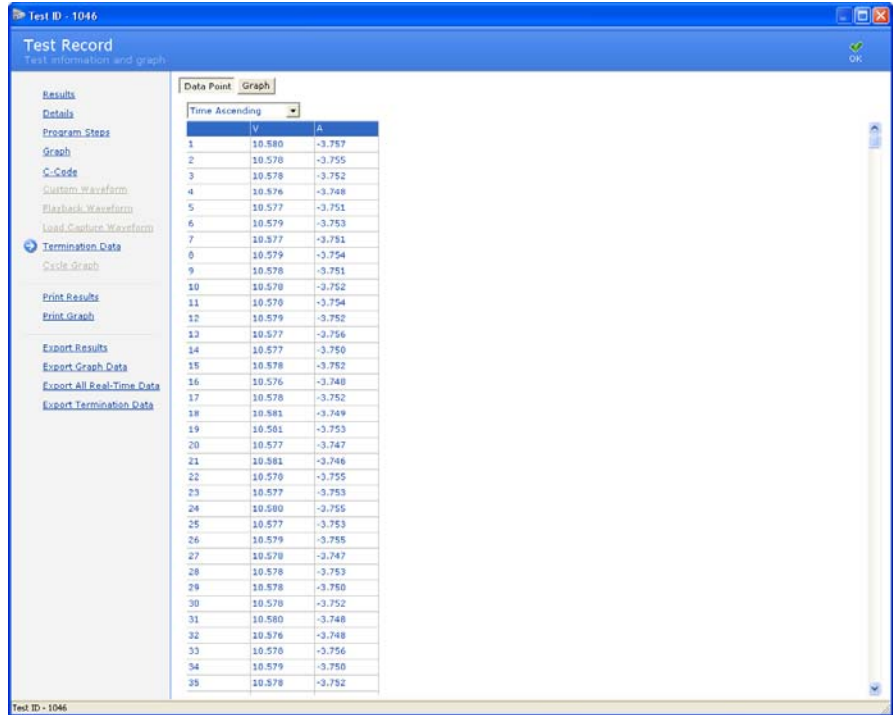
**Note:** If no Playback Waveform was used in the program, this option will be grayed out.



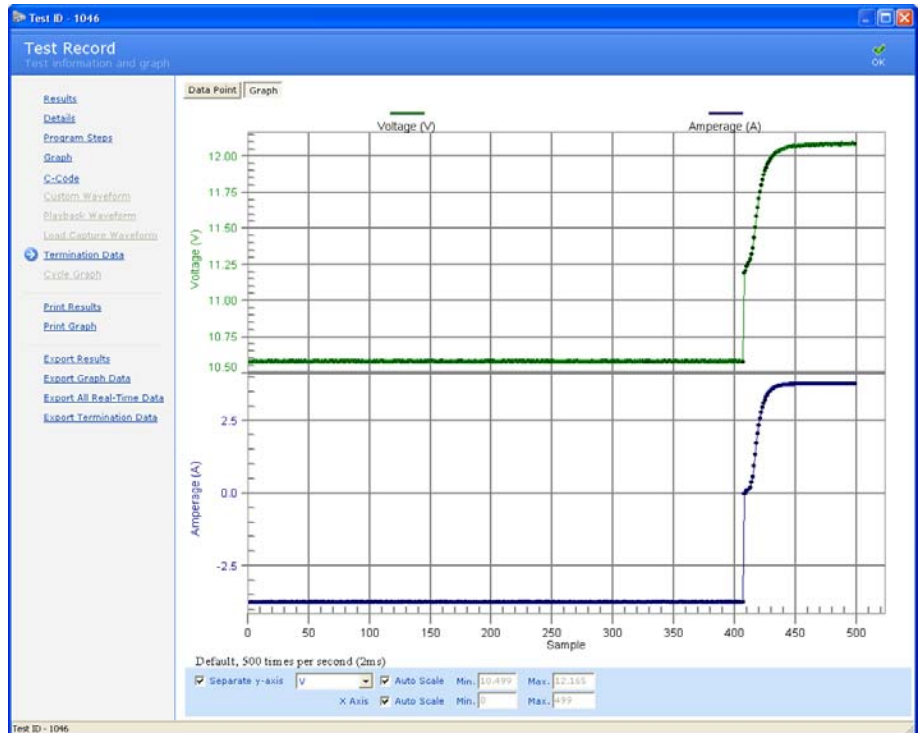
### 3.6.3.11 View Termination Data

To view termination data:

In the **Test Record** window, click **Termination Data**. Click the **Data Point** tab to view data point information.



Click the **Graph** tab to view termination data in graph form.



### 3.6.3.12 Cycle Graph

To view a cycle graph:

In the **Test Record** window, click **Cycle Graph**.

### 3.6.3.13 Print Results

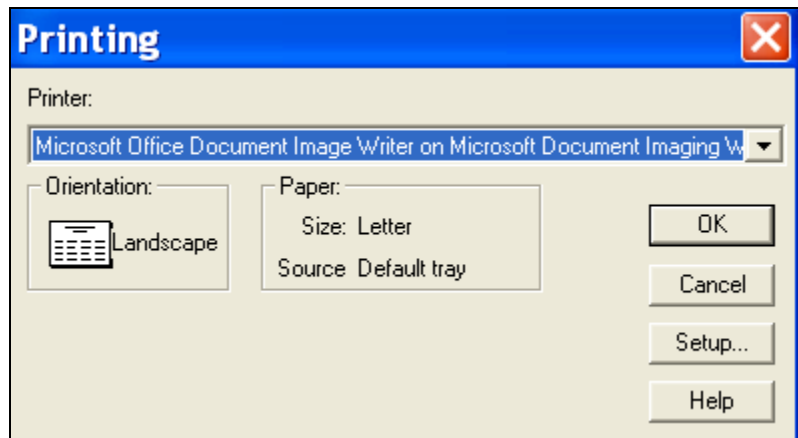
To print a hardcopy of the test results:

In the **Test Record** window, click **Print Results**.

### 3.6.3.14 Print a Battery Test Graph

To print a hardcopy of the battery test graph:

1. In the **Test Record** window, click **Print Graph**.
2. The **Printing** window appears.

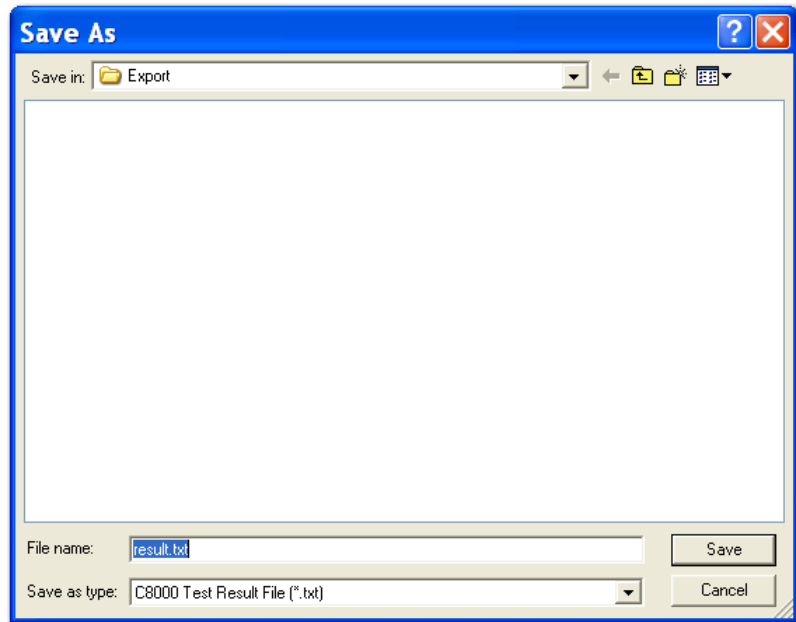


3. Click **OK** to print the graph.

### 3.6.3.15 Export Test Record Results to a File

To export test record results:

1. In the **Test Record** window, click **Export Results**. The **Save As** window appears.

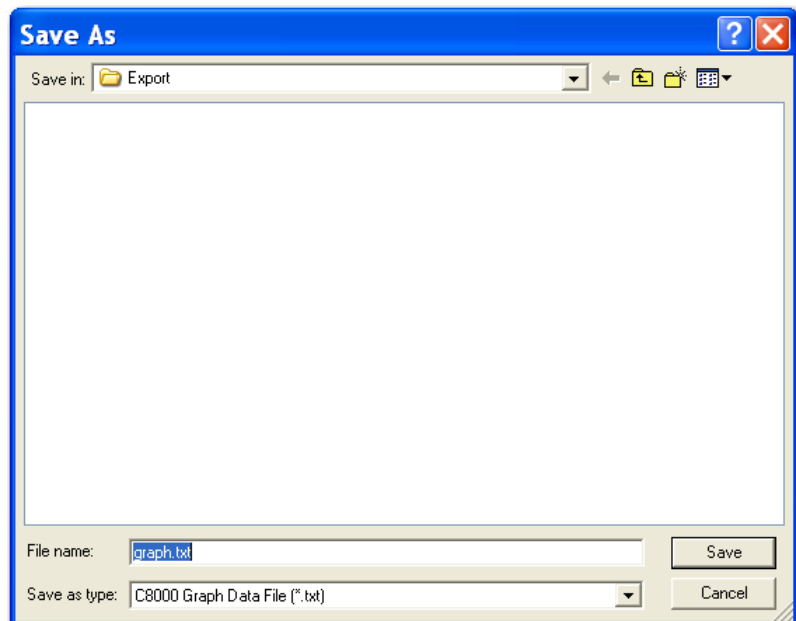


2. Click the *File name* field and type a new name for the file, if necessary.
3. Click **Save**.

### 3.6.3.16 Export Graph Data To a File

To export graph data:

1. In the **Test Record** window, click **Export Graph Data**. The **Save As** window appears.





2. Click the *File name* field and type a new name for the file, if necessary.
3. Click **Save**.

### 3.6.3.17 Export Termination Data to a File

To export termination data:

1. In the **Test Record** window, click **Export Termination Data**. The **Save As** window appears.
2. Click the *File name* field and type a new name for the file, if necessary.
3. Click **Save**.

---

## 3.7 Reports

Reports can be customized using **Report Templates** to display required test result fields, and to specify optional report headers and a report bitmap.

After setting the default Report Template, test results will appear as described by the Report Template.

---

### 3.7.1 Print Battery Test Reports

To print a battery test report:

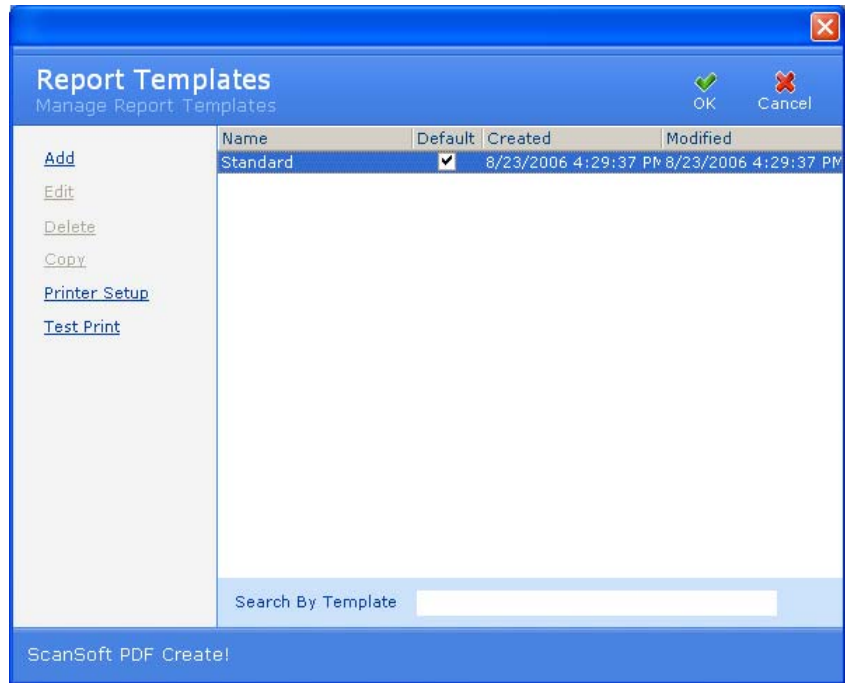
1. From the **C8000** menu, click **Results**. The **Test Results** window appears.
2. In the **Test Results** window, search for test records by Battery ID, c-code, or date range.
3. Click **Search**.
4. Select one or more rows in the results.
5. Click **Print Record**.

---

### 3.7.2 Add, Edit, and Delete Report Templates

#### 3.7.2.1 Add a Report Template:

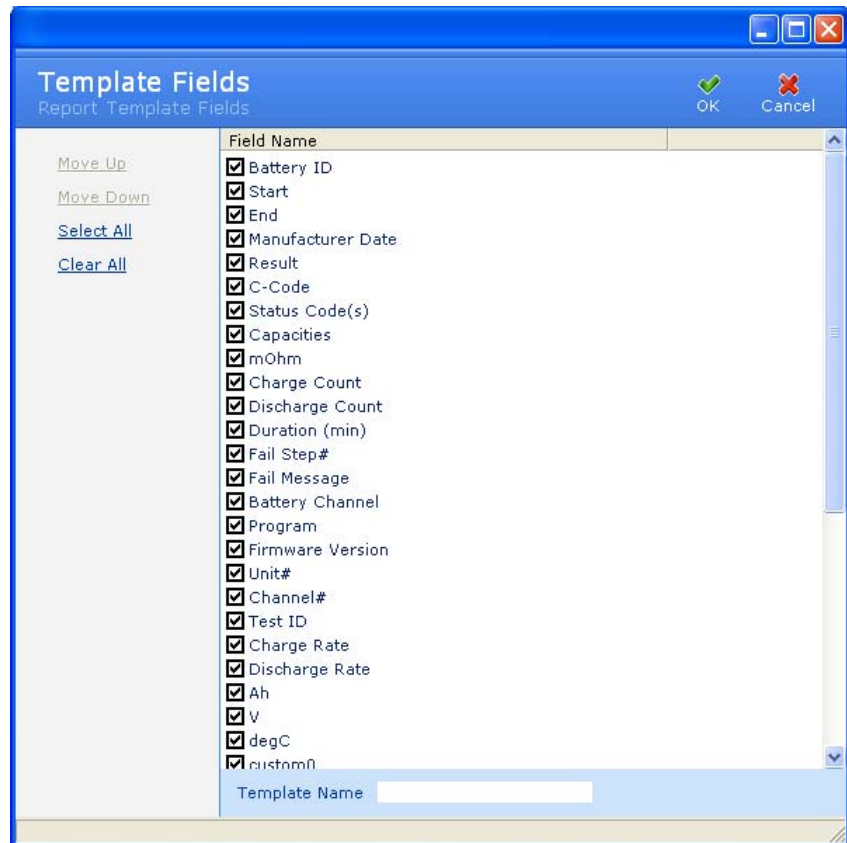
1. From the **Tools** menu, click **Report Templates**. The **Report Templates** window appears.



2. Click **Add**. The **Password** window appears



3. Enter your password and click **OK**. The **Template Fields** window appears.

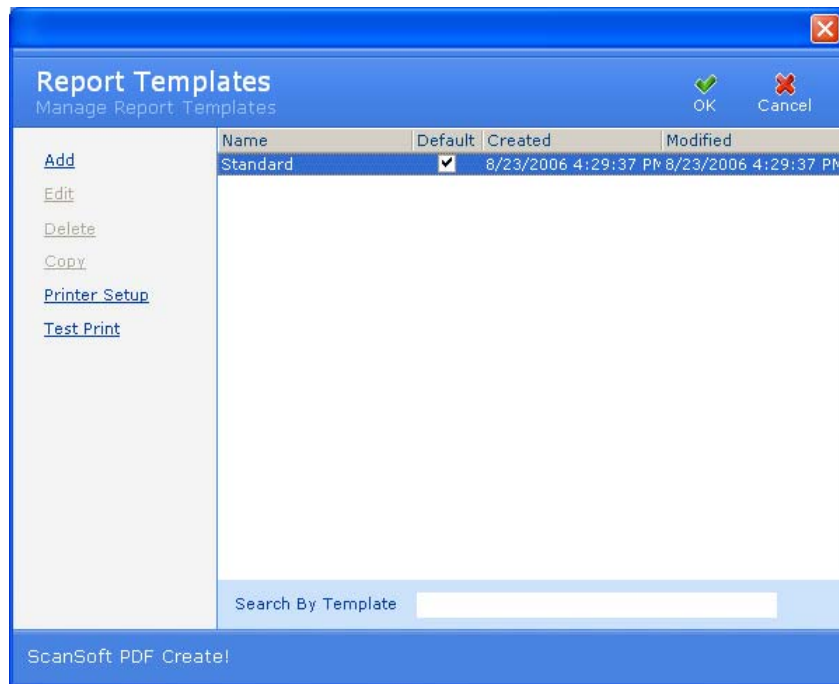


4. In the *Template Name* field, type the name for the new template.
5. By default, all field names are automatically selected. Clear the check box next to a field's name to exclude that field from the report. Select the check box next to the field's name to include that field in the report that will be created from this report template. To quickly select all fields for inclusion in the report template, click **Select All**; to exclude all fields from the report template, click **Clear All**.
6. To move the position of a field up or down in the report, click the field name and then click **Move Up** or **Move Down**. This sets the order that the fields will appear in reports using this template.
7. When you have finished selecting the fields for the report template, click **OK** to save the template. The new report template appears in the list of templates.

### 3.7.2.2 Edit a Report Template:

To edit a report template:

1. From the **Tools** menu, click **Report Templates**.  
The **Report Template** window appears.

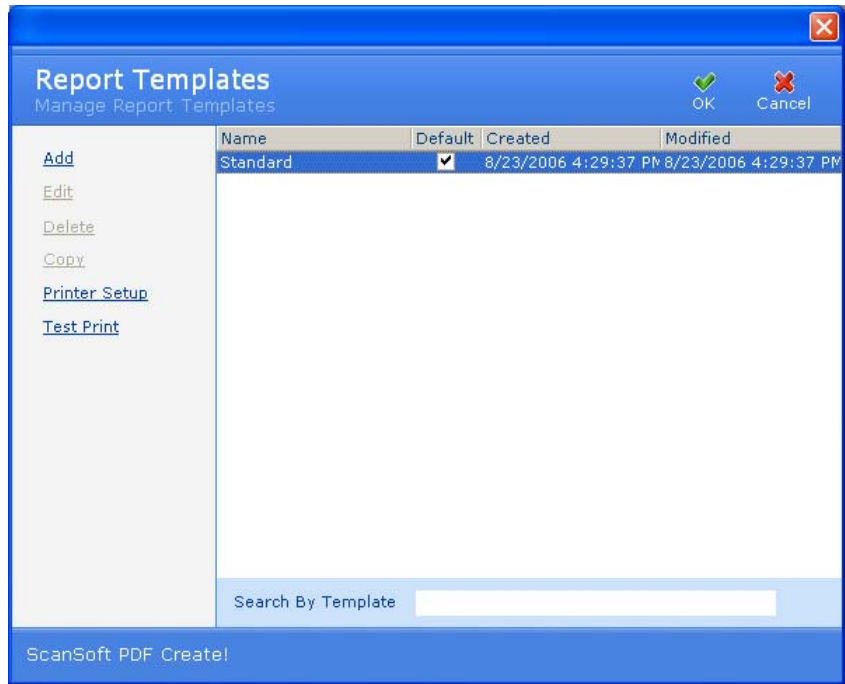


2. From the list of templates, select the template you want to edit.
3. Click **Edit**. If security is enabled, a password prompt appears. Specify the correct password to continue with edits to the report template.
4. Clear the check box next to a field's name to exclude that field from the report. Select the check box next to the field's name to include that field in the report that will be created from this report template. To quickly select all fields for inclusion in the report template, click **Select All**; to exclude all fields from the report template, click **Clear All**.
5. To move the position of a field up or down in the report, click the field name and then click **Move Up** or **Move Down**. This sets the order that the fields will appear in reports using this template.
6. Click **OK** to save the changes you have made to this report template.

### 3.7.2.3 Set the Default Report Template

When you print a report, it will be printed based on the default template. The first report template you create is automatically set as the default template. You can select which template is to be the default template.

1. From the **Tools** menu, click **Report Template**.  
The **Report Templates** window appears.

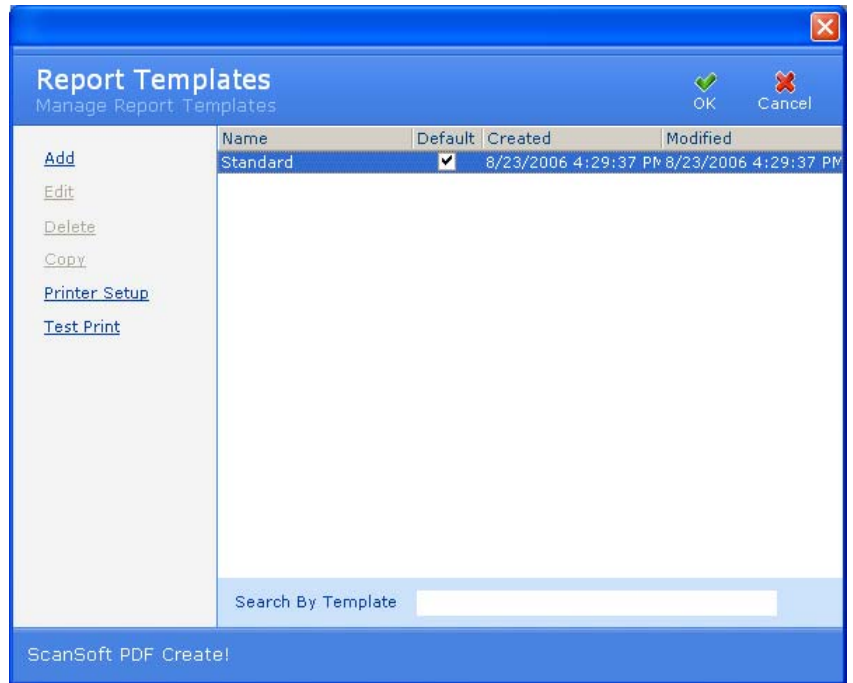


2. Place a check mark in the *Default* check box to set the template as the default report template.
3. Click **OK**.

### 3.7.2.4 Delete a Report Template

A protected report can be deleted after protection is removed. The default report template can be deleted once another template is set as the default.

1. From the **Tools** menu, click **Report Template**.  
The **Report Templates** window appears.

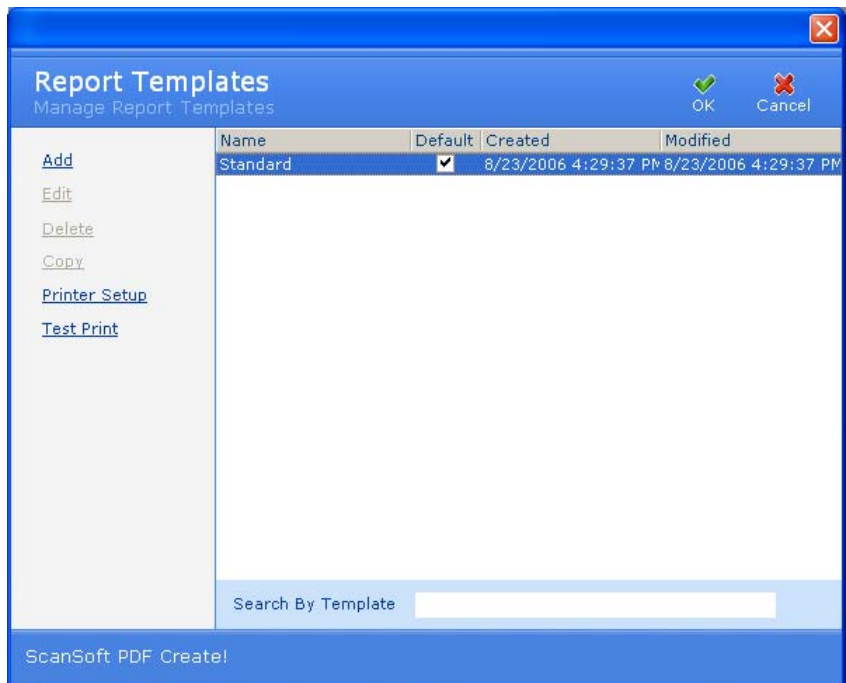


2. Select the report template to delete.
3. Click **Delete**. A **Confirmation** window appears. Click **Yes**. The report template is deleted.
4. Click **OK**.

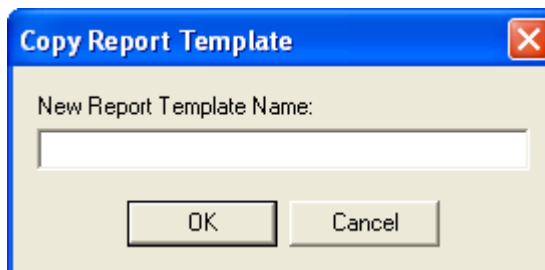
### 3.7.2.5 Copy a Report Template

It is possible to create a report template based on an existing template record. Making a copy of an existing template and then editing the copy to create the new template do this.

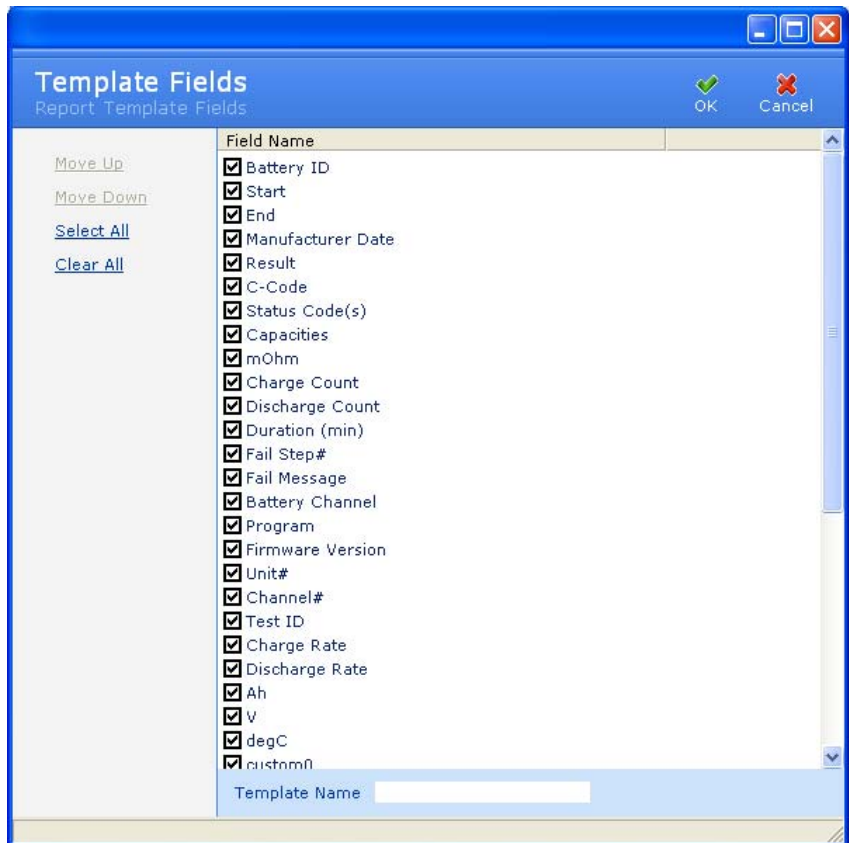
1. From the **Tools** menu, click **Report Template**. The **Report Templates** window appears.



2. Select the template to copy.
3. Click **Copy**. The **Copy Report Template** window appears.



4. Type a name for the new report template.
5. Click **OK**. The **Template Fields** window appears.



Clear the check box next to a field's name to exclude that field from the report template. Select the check box next to the field's name to include that field in the report template. To quickly select all fields for inclusion in the report template, click **Select All**; to exclude all fields from the report template, click **Clear All**.

To move the position of a field up or down in the report template, click the field name and then click **Move Up** or **Move Down**. This sets the order that the fields will appear in reports using this template.

6. Click **OK**. The new report template appears in the **Report Template** window.

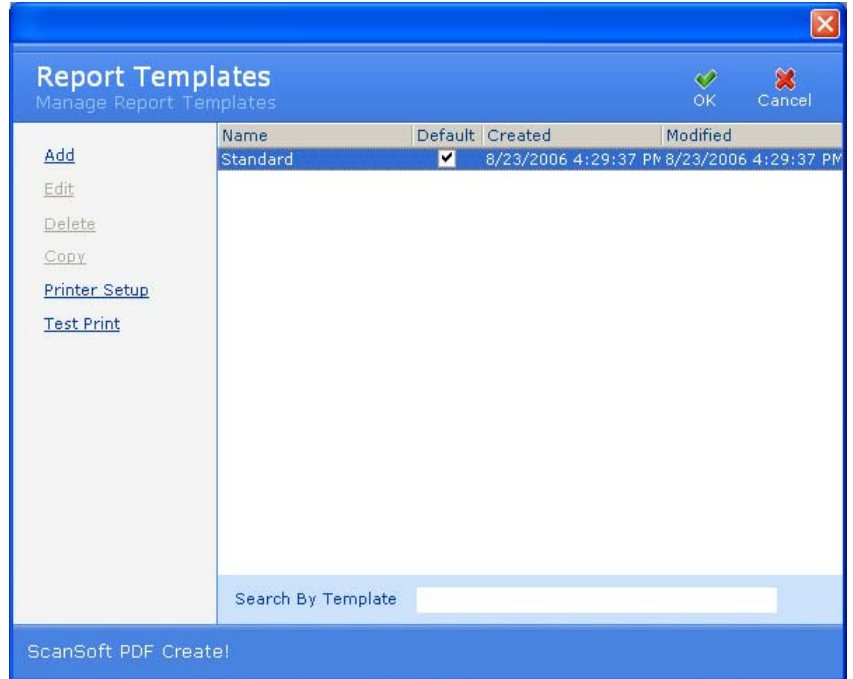
### 3.7.2.6 Set Up Your Printer

Report printing requires that a printer driver is installed on the operating system and that a default printer driver is specified in the Printers folder (**Start > Settings > Printers**). Next, specify the default windows printer driver by right-clicking the printer's icon and selecting *Set as Default Printer*. This must be done at the operating system level before running BatteryLab.

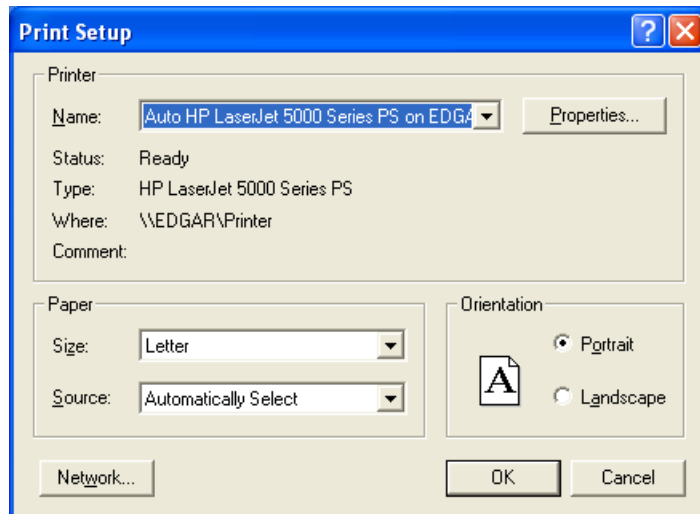


After launching BatteryLab the first time, specify the default Windows printer driver for printing reports.

1. From the **Tools** menu, select **Report Template**. The **Report Templates** window appears.



2. Click **Printer Setup**. The **Print Setup** window appears.



3. Select the properties (paper size and source and the printing orientation) for the printer test.
  4. Click **OK**.
- After specifying printer settings, print a test.

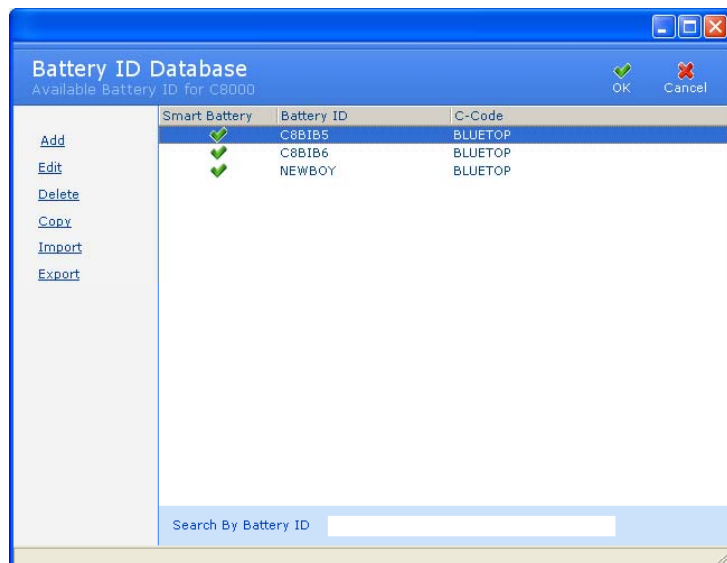
- Click **Test Print**. A sample test report is printed.

## 3.8 Battery ID Database

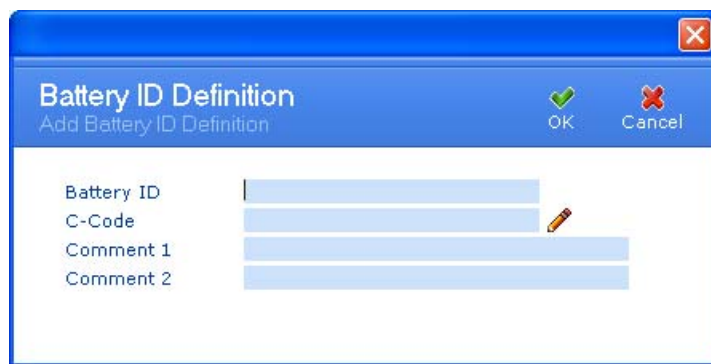
A battery ID identifies a physical battery with a unique ID. The **Battery ID Database** window displays the battery ID and the corresponding c-code for each battery ID. (**Note:** The corresponding c-code may be changed at any time.) The **C-Code Database** window describes a specific battery type and the settings required to process that battery type.

### 3.8.1 Add a Battery ID

1. From the **Database** menu, click **Battery ID**. The **Battery ID Database** window appears. A green check mark in the *Smart Battery* column indicates that the associated c-code is configured as an SM-Bus c-code.



2. Click **Add**. The **Add Battery ID Definition** window appears.



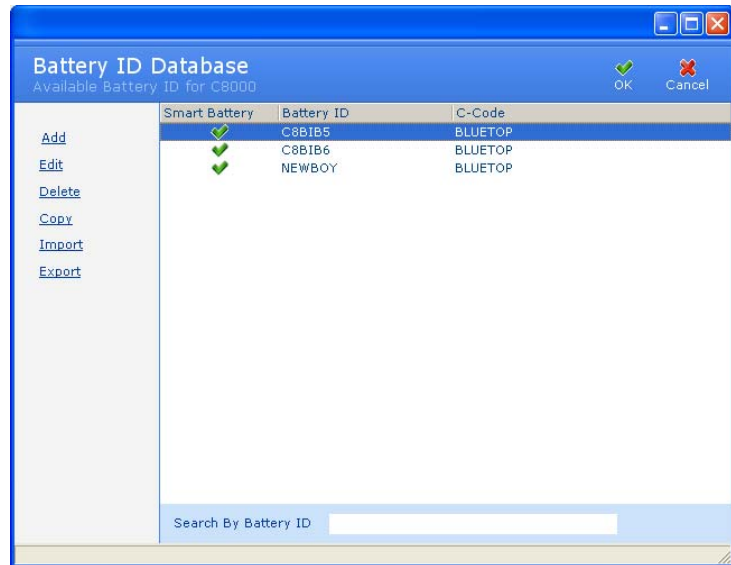
3. Type a name for the battery in the *Battery ID* field.

4. Click the **Pencil** icon next to the *C-Code* field. The **C-Code Database** window appears. Select a C-Code for the battery ID and click **OK**.
5. Type any remarks in the *Comment 1* and *Comment 2* fields.
6. Click **OK**. The new battery ID appears in the **Battery ID Database** window.

### 3.8.2 Edit a Battery ID

To edit a battery ID:

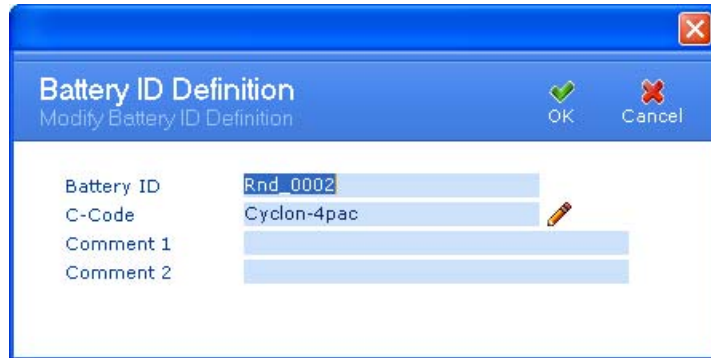
1. From the **Database** menu, click **Battery ID**. The **Battery ID Database** window appears.



2. Select the battery ID to edit.
3. Click **Edit**. If database security is enabled, the **Password** window appears.



4. Enter your password and click **OK**. The **Battery ID Definition** window appears.

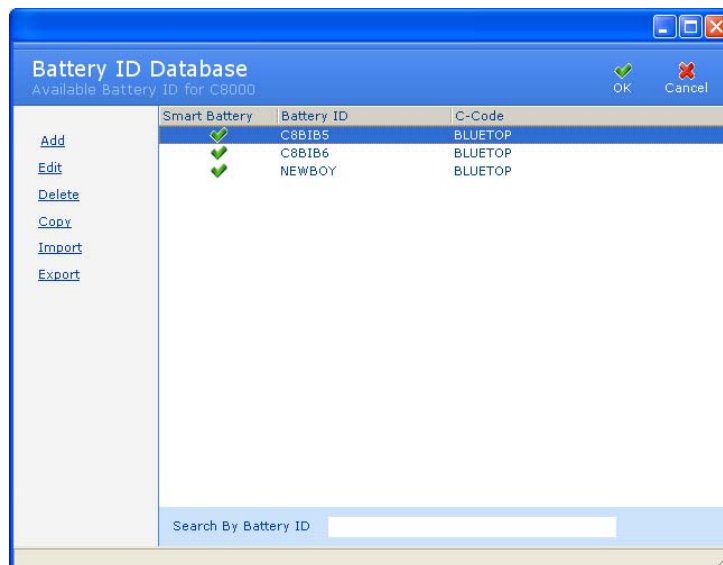


5. Edit the information, as required.
6. Click **OK**.

### 3.8.3 Delete a Battery ID

To delete a battery ID:

1. From the **Database** menu, click **Battery ID**. The **Battery ID Database** window appears.



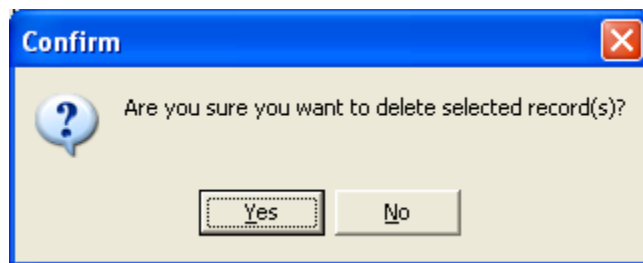
2. Select the battery ID to delete.
3. Click **Delete**. If database security is enabled, the **Password** window appears.



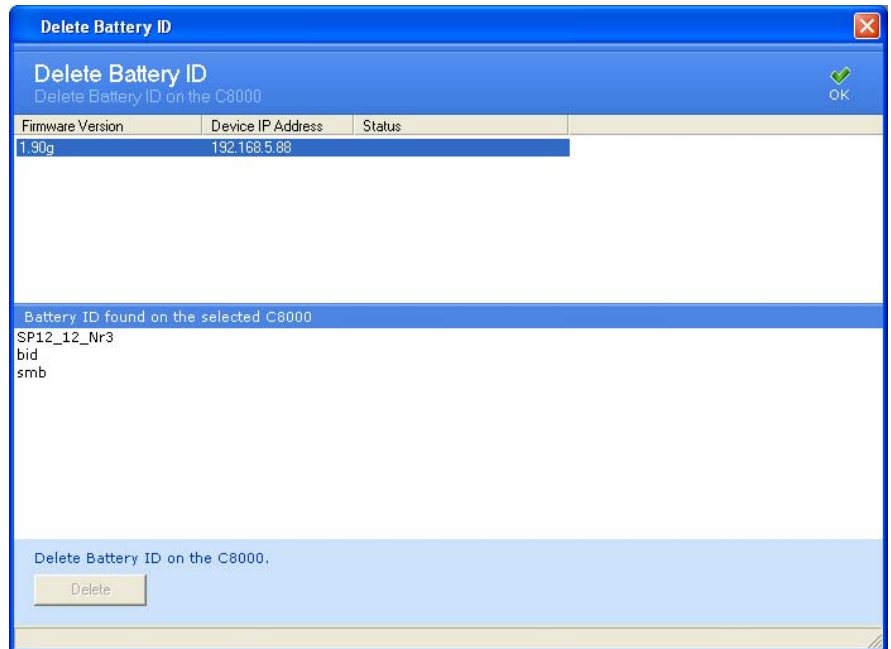
4. Enter your password and click **OK**. The **Delete Options** window appears.



5. If you select *Delete from BatteryLab* option, the **Confirm** window appears. Click **Yes** to delete the battery ID.



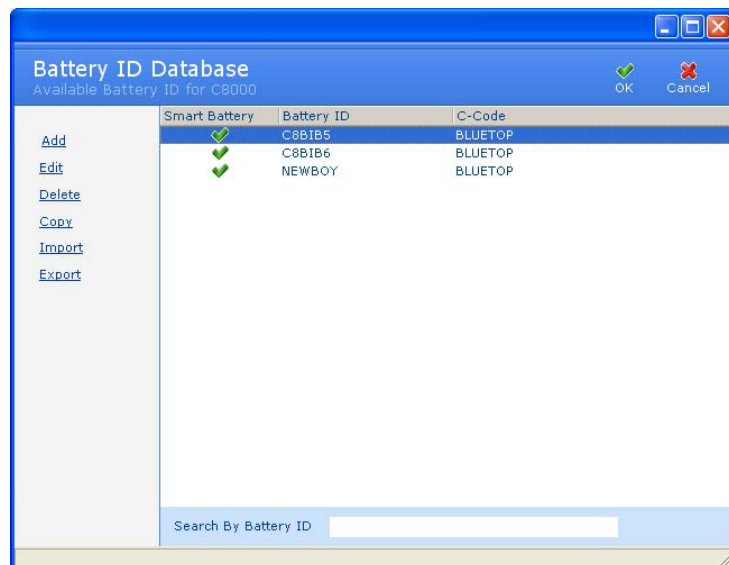
If you select the *Delete from Connected C8000*, the **Delete Battery ID** window appears. The top half of this window lists all connected C8000s while the bottom half of this window lists the battery IDs for the selected C8000. Select the battery ID to delete and click **Delete**.



### 3.8.4 Copy a Battery ID

Copy a battery ID to create a battery ID:

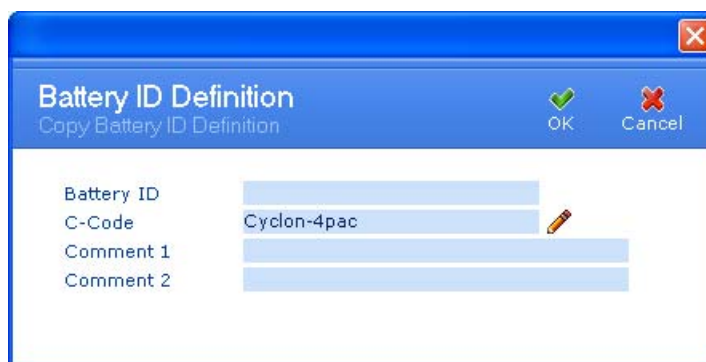
1. From the **Database** menu, click **Battery ID**. The **Battery ID Database** window appears.



2. Select the battery ID to copy.
3. Click **Copy**. If database security is enabled, the **Password** window appears.



4. Enter your password and click **OK**. The **Battery ID Definition** window appears.



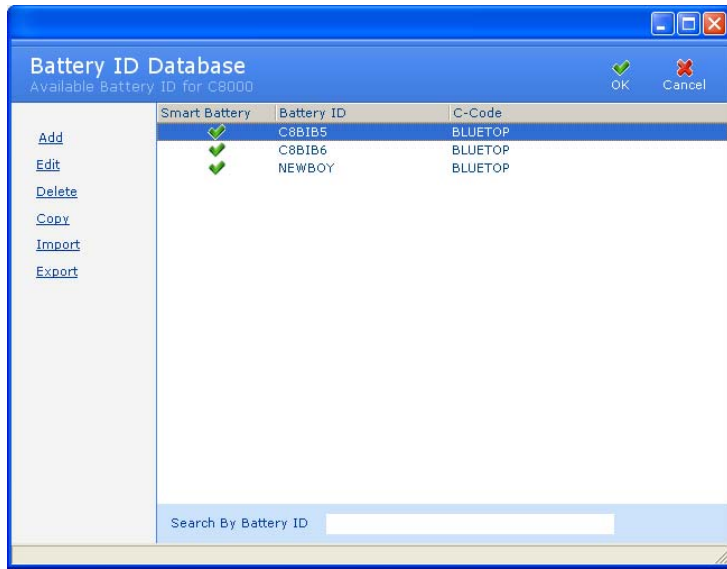
5. Click **OK**. The new battery ID appears in the **Battery ID Database** window.

---

### 3.8.5 Import a Battery ID

To import a battery ID from a file:

1. From the **Database** menu, click **Battery ID**. The **Battery ID Database** window appears.

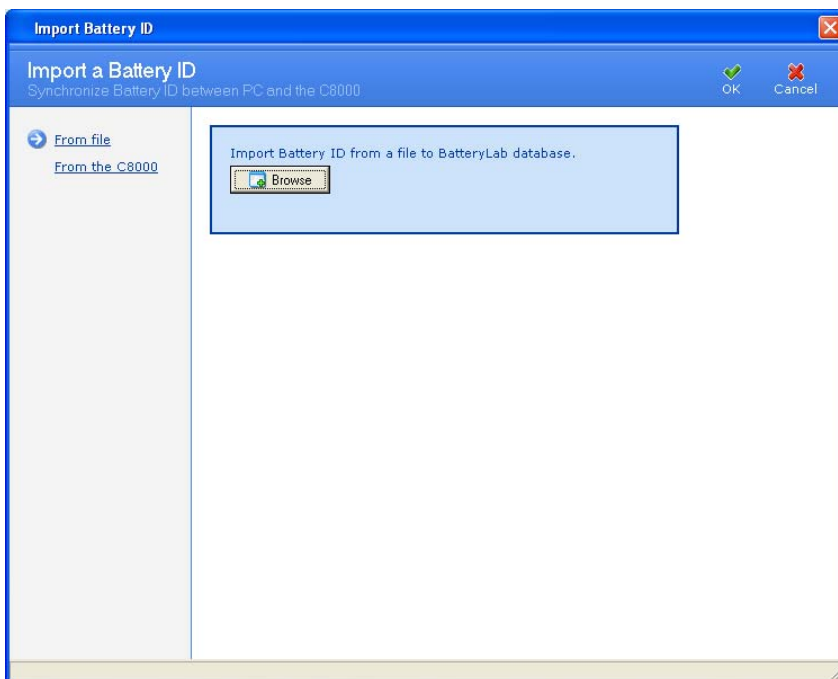


2. Click **Import**. If database security is enabled, the **Password** window appears.

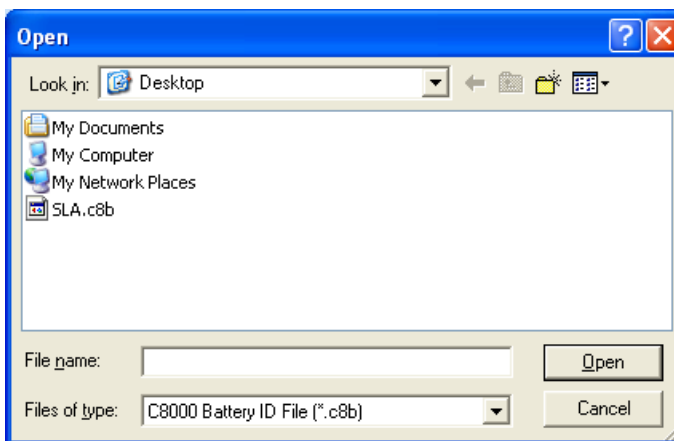


3. Enter your password and click **OK**. The **Import a Battery ID** window appears.

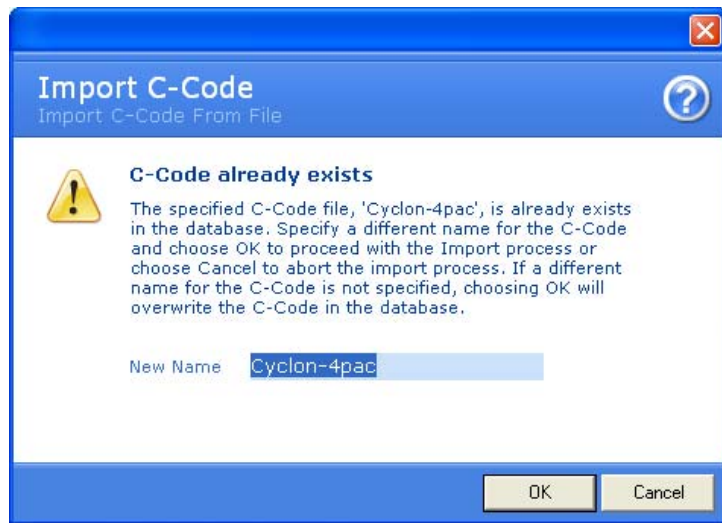




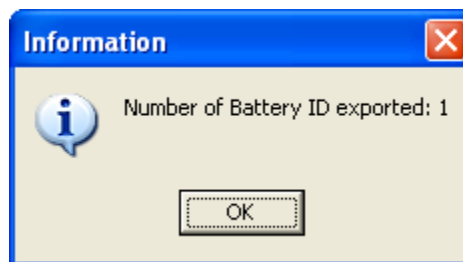
4. Click **Browse**. The **Open** window appears.



5. Select the file that contains the battery ID information to import.
6. Click **Open**. If the c-code specified in the to-be-imported file already exists, this error window will appear. Type a new name for the c-code and click **OK**.

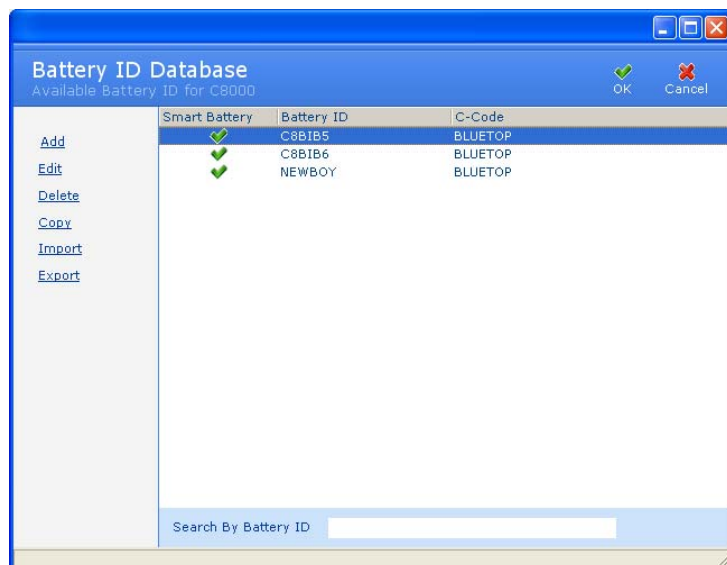


7. An **Information** window appears with the number of files imported.



To import a battery ID from the C8000:

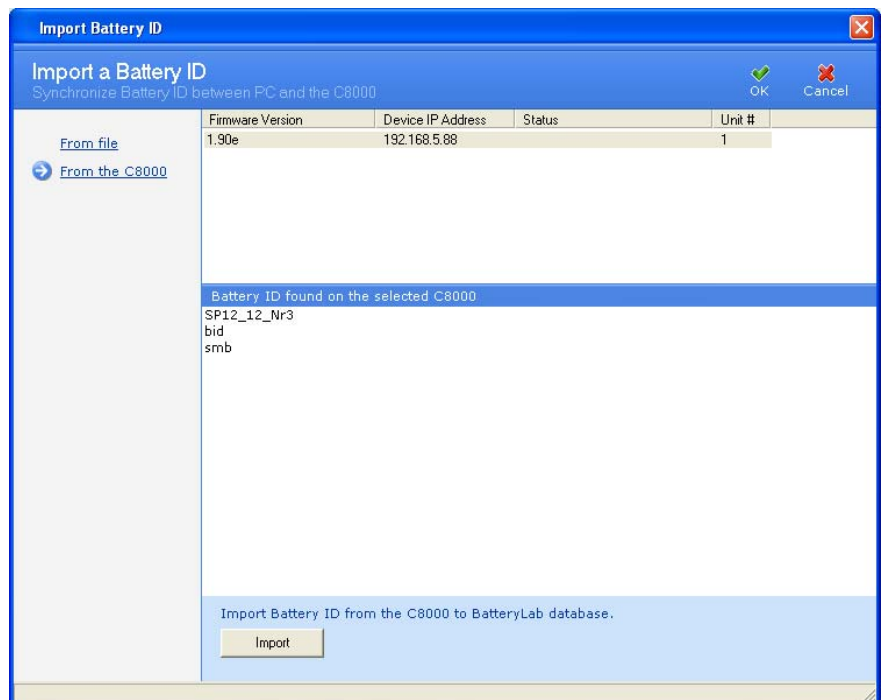
1. From the **Database** menu, click **Battery ID**. The **Battery ID Database** window appears.



2. Click **Import**. If database security is enabled, the **Password** window appears.



3. Enter your password and click **OK**. The **Import Battery ID** window appears.

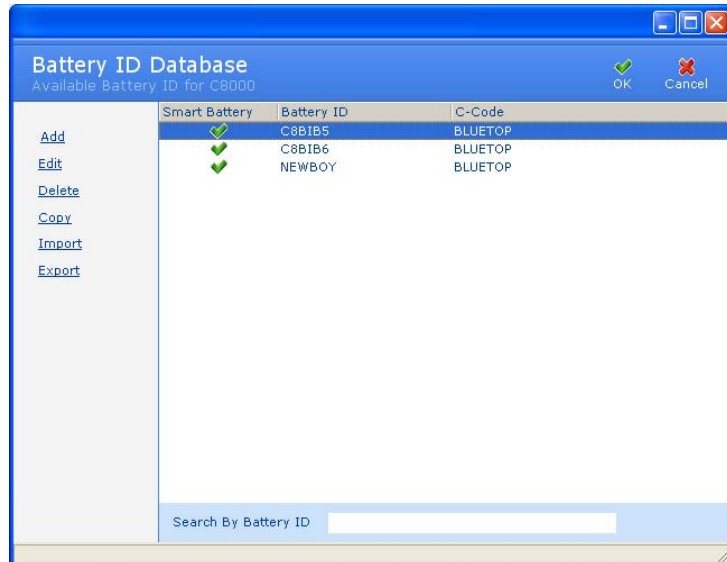


4. Click *From the C8000*.
5. Select the C8000 that contains the battery ID information to import.
6. Click **Import** and click **OK**.

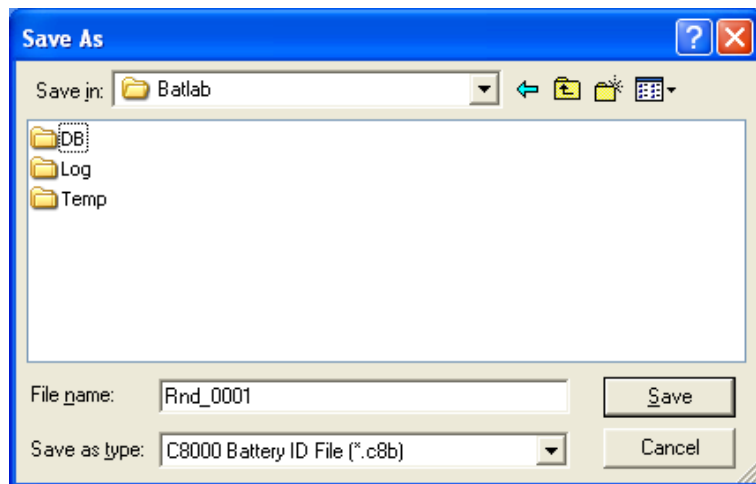
### 3.8.6 Export a Battery ID

To export a battery ID to a file:

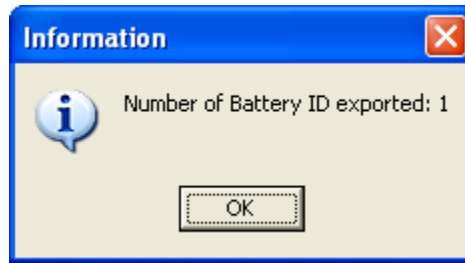
1. From the **Database** menu, click **Battery ID**. The **Battery ID Database** window appears.



2. Select the battery ID to export. Hold the CTRL key down to select multiple records.
3. Click **Export**. Click **Browse**. The **Save As** window appears.

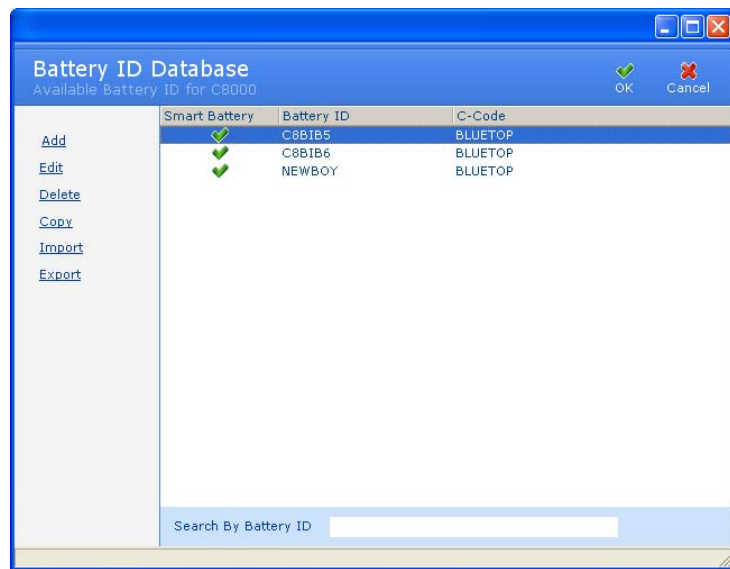


4. Type a name for the export file in the *File name* field.
5. Click **Save**.
6. An **Information** window appears with the number of files exported.



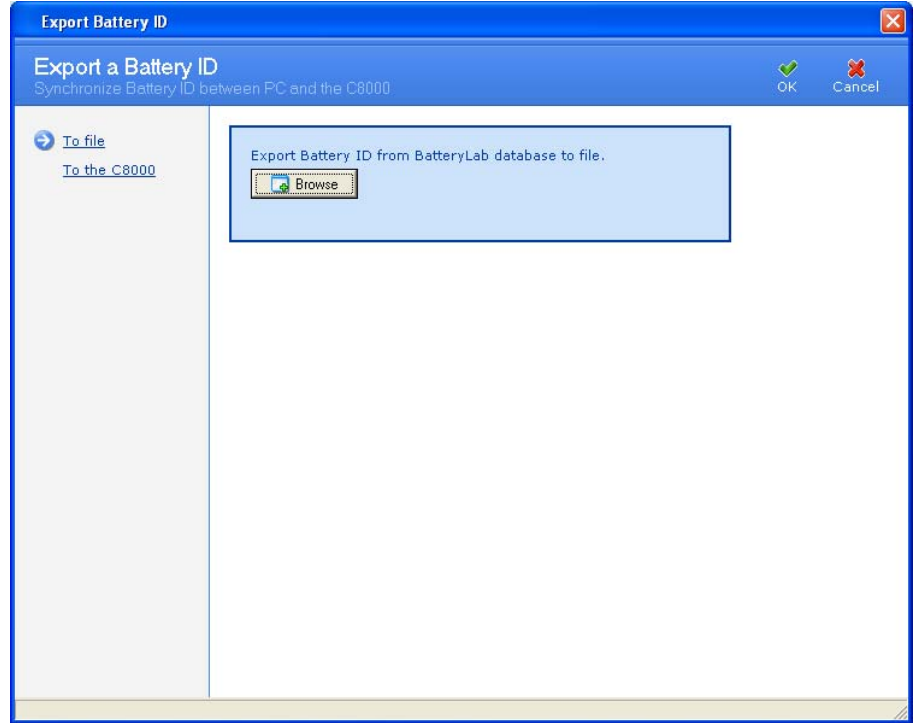
To export a battery ID to the C8000:

1. From the **Database** menu, click **Battery ID**. The **Battery ID Database** window appears.

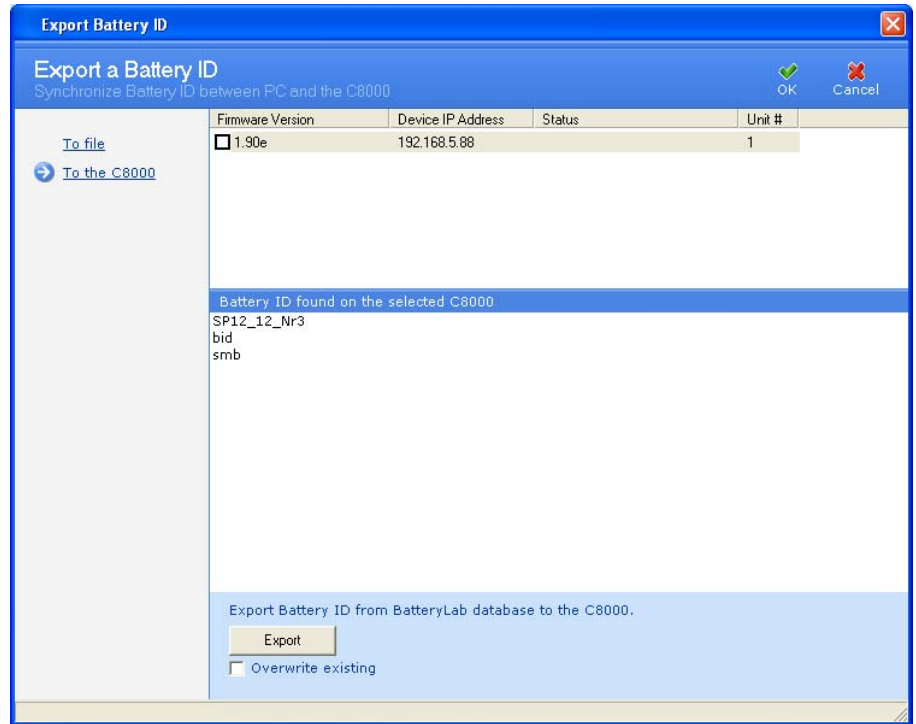


2. Select the battery ID to export. Hold the CTRL key down to select multiple records.

3. Click **Export**. The **Export Battery ID** window appears.



4. Click **To the C8000**. A list of connected C8000s appears.



5. Click **Export**.

### 3.8.7 Search for a Battery ID

The BatteryLab database may contain hundreds, or even thousands, of battery IDs. To find a battery ID, click the *Search By Battery ID* field to move the cursor to that field.

A screenshot of a software interface showing a search field. The text "Search By Battery ID" is displayed in blue on the left side of a light blue rectangular box. To the right of the text is a white input field with a vertical cursor line at the beginning.

Next, type the first one or two characters of the battery ID to find. As BatteryLab locates the partial ID, it will highlight the corresponding ID in the **Battery ID Database** window.

### 3.8.8 Sort Battery IDs

The BatteryLab database may contain many battery IDs. To sort the battery IDs in ascending order click the *Battery ID* or *C-Code* column in the **Battery ID Database** window. Click the column a second time to sort the battery IDs in descending order.

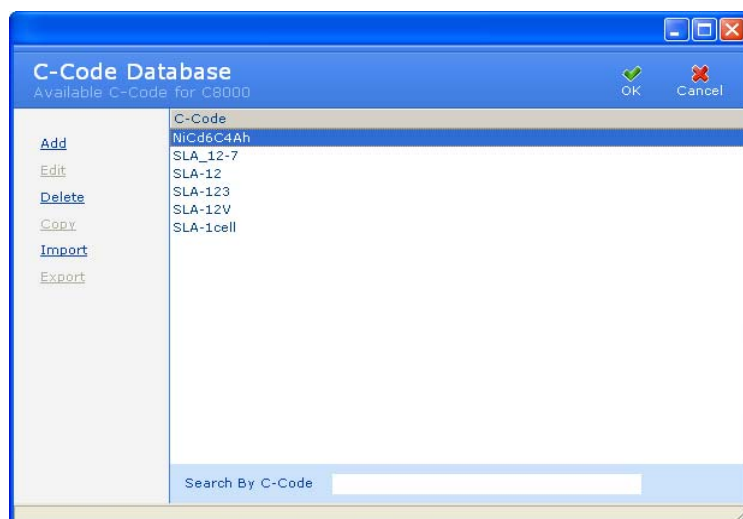
## 3.9 C-Code

The **C-Code Database** window displays a list of C-Code records in the BatteryLab database. A C-code (Configuration Code) is a list of parameters specific to the Battery under Test. These parameters determine the service algorithms that will be applied to the battery by the C8000.

### 3.9.1 Add a C-Code

To add a c-code to BatteryLab:

1. From the **Database** menu, click **C-Code**. The **C-Code Database** window appears.



- Click **Add**. The **C-Code Definition** window appears.

The screenshot shows the 'C-Code Definition' window with the following parameters and values:

Parameter	Value	Unit
Chemistry	WICd	
Number of cells	5	
Rating	4.000	Ah
Charge rate	4.000	A
Discharge rate	4.000	A
Trickle charge rate	0.200	A
Trickle discharge rate	0.480	A
Low temperature limit	5	deg C
High temperature limit	45	deg C
Reverse Load Weight (0 = DC)	9	percent (%)
Delta T (dT)	1	deg C/min
Negative slope (dV)	0.048	v
End of discharge	6.000	v
End of recondition	2.400	v
Rapid charge voltage	6.000	v
Negative slope wait time (0 = off)	2	C-minute
Target capacity	80	percent (%)
Perform automatic ohmtest	Yes	
Charge timeout (0 = off)	150	C-minute
Discharge timeout (0 = off)	150	C-minute
Mili-ohms pass/tail point	300	
Min. safe operating voltage	1.920	v
Max. safe operating voltage	10.800	v
Max. safe operating charge current	8.000	A
Max. safe operating discharge current	8.000	A
Max. safe operating temperature	60	deg C

At the bottom, the 'C-Code Name' field is empty. There are two checkboxes: 'Smart Battery' (unchecked) and 'Use External Load Maximum Discharge Rate' (unchecked).

- If required, edit the detail fields in the **C-Code Definition** window to describe the new c-code.
- Type a name for the new c-code in the *C-Code Name* field.
- Select the *Smart Battery* check box to convert the C-Code into an SM-Bus compatible C-Code to be used with smart batteries.
- Select the *Use External Load Maximum Discharge Rate* check box to bypass the parameter *Max. safe operating discharge current* and use the maximum discharge current of the external load. Bypass only occurs if the *Discharge Playback* action is used in a program and is currently active.
- Click **OK**. The new c-code appears in the **C-Code Database** window.

### 3.9.2 Add a SM-BUS (Smart Battery) C-Code

To manually create a SM-BUS C-code see section [3.9.1 Add a C-Code](#) and to automatically create a SM-BUS C-code continue with this section.

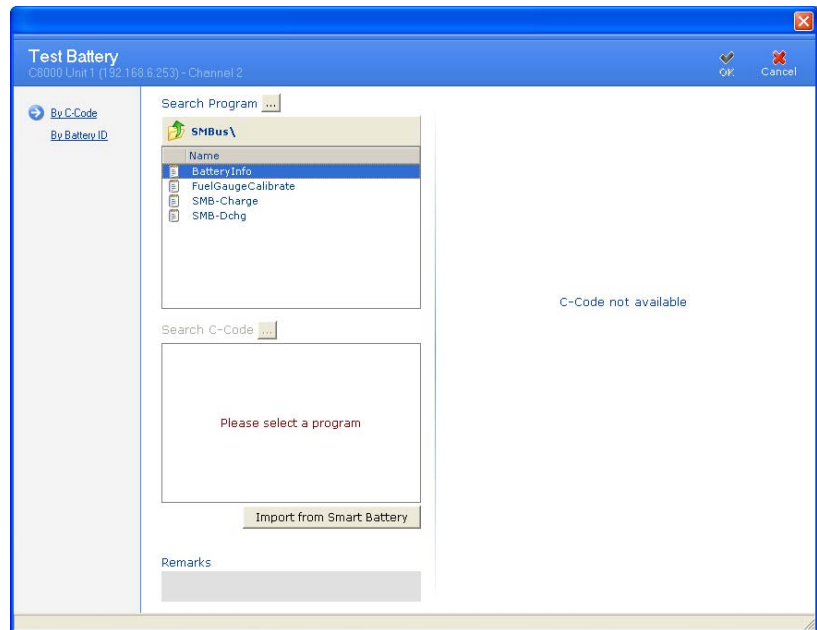
**Note:** All SM-BUS functions require that additional lines to be attached to the SM-BUS battery, from the Auxillary I/O port cable. Attach the purple/white wire (pin number nine (9)) to the Clock line and the brown/white wire (pin number ten (10)) of the data line of the SM-BUS battery. Also, ensure that one of the



ground lines, from the Auxillary cable, is connected to the ground or negative of the battery. Example: Black wire (pin number seven (7) is connected to the negative terminal of the SM-BUS battery. (Connection to the battery may vary depending on the battery configuration. Consult the battery specifications before proceeding with the connection) for a full description on the Auxillary I/O port cable.

To automatically add a SM-BUS c-code in BatteryLab:

1. Select a C8000, choose a channel, select and right-click on the channel and choose **Test Battery**. The **Test Battery** window appears..

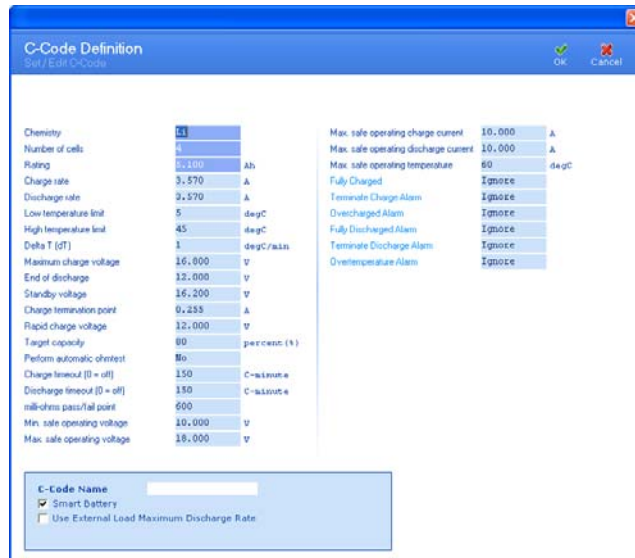


2. Click **Import from Smart Battery** and **Import SM-BUS C-Code** window will appear.



3. After all required data has been downloaded from the Smart Battery registers the **C-Code Definition** window

appears.



The following table shows, which register where automatically, downloaded. All other c-code fields are dynamically adjusted to recommended values.

<i>C-code Field</i>	<i>SM-BUS Register</i>	<i>Description</i>
Chemistry	0x22	Displays the chemistry type reported
Rating	0x18	Displays the Design Capacity reported
Charge Rate	0x14*	Displays the requested Current
Discharge Rate	0x14*	Displays the requested Current
Maximum Charge Voltage	0x15**	Displays the requested Charge Voltage

\*If the requested current is ZERO (0), then the system will default to the a 1.0C rate

\*\* This register is only downloaded if the Chemistry type is equivalent to a CC-CV charging algorithm.

- If required, edit the detail fields in the **C-Code Definition** window to describe the new c-code.
- Type a name for the new c-code in the *C-Code Name* field.

The *Smart Battery* check box is automatically checked.

- Select the *Use External Load Maximum Discharge Rate* check box to bypass the parameter *Max. safe operating discharge current* and use the maximum discharge current of the external load. Bypass only occurs if the *Discharge Playback* action is used in a program and is currently active.

7. The SM-Bus codes will have an additional six (6) options available. These fields control the actions that will occur when the C8000 retrieves the associated flag from the Battery Status register.

*When active the C-code is enabled for SM-BUS batteries and the following parameters become available:*

- 1) Fully Charged
- 2) Terminate Charge Alarm
- 3) Overcharge Alarm
- 4) Fully Discharged Alarm
- 5) Terminate Discharge

*Any of the above options can be set to one the following conditions;*

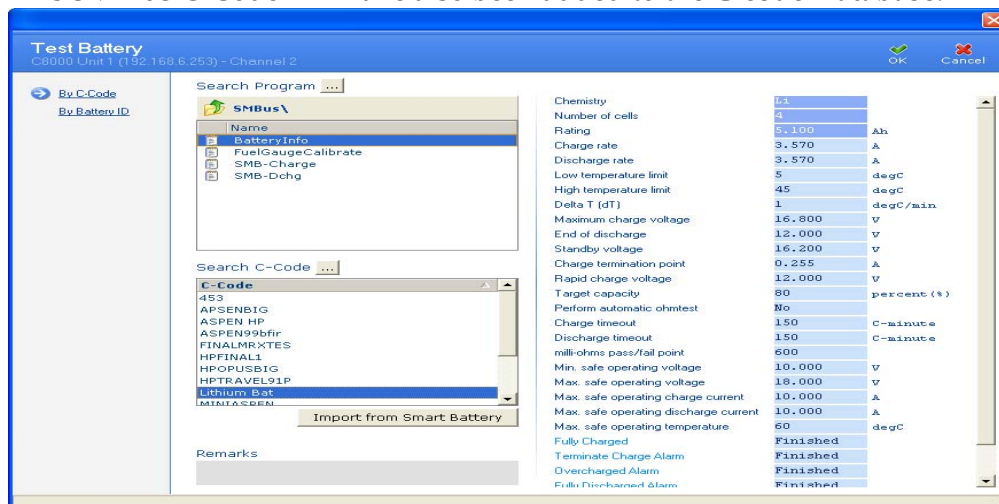
- a. Finished –will terminate the program successfully on flag
- b. Fail –will terminate the program with a failure on flag
- c. Ignore – will ignore the flag.

- 6) Over temperature Alarm options;

- a. Ignore – will ignore the flag.
- i. Retry x (1~10) – will wait for multiple flag conditions before terminating with a failure. (Over-temperature only).

8. Click **OK**. The new c-code appears in the **Test Battery** window.

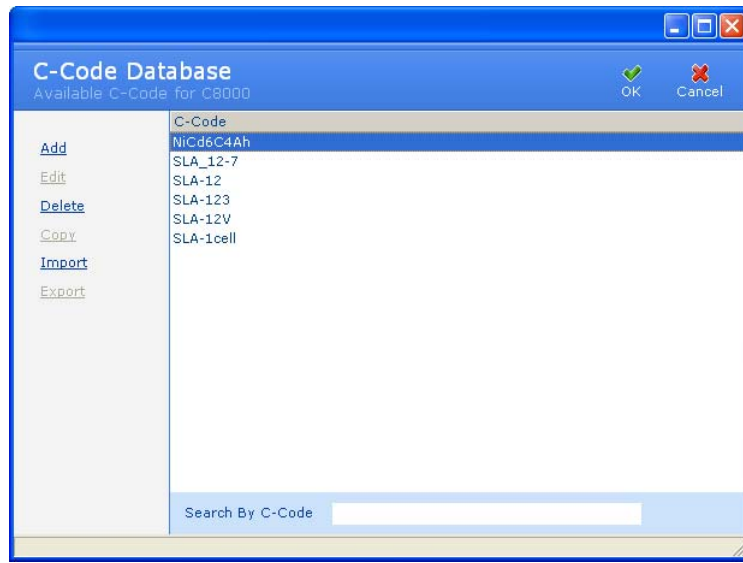
- a. This SM-Bus C-Code will have also been added to the **C-code Database**.



### 3.9.3 Edit a C-Code

To edit a c-code:

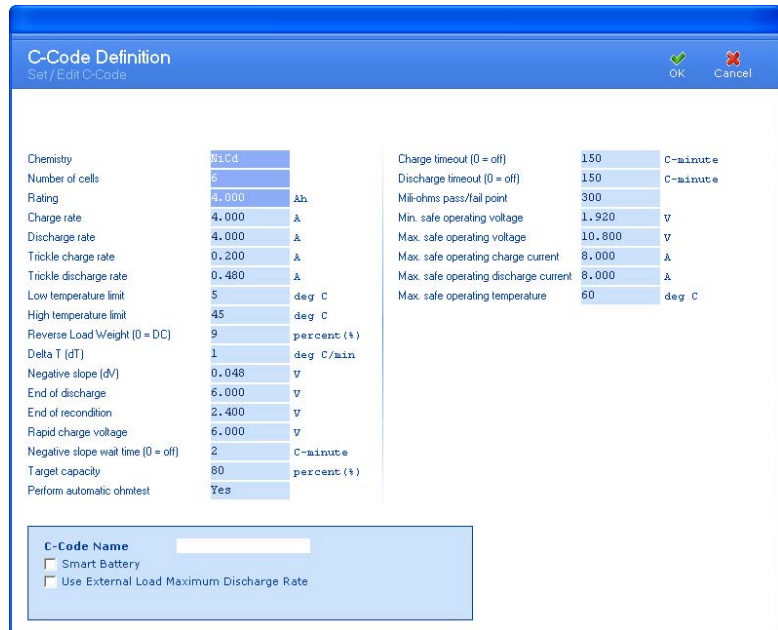
1. From the **Database** menu, click **C-Code**. The **C-Code Database** window appears.



2. Select the c-code to edit.
3. Click **Edit**. If database security is enabled, the **Password** window appears.



4. Enter your password and click **OK**. The **C-Code Definition** window appears.

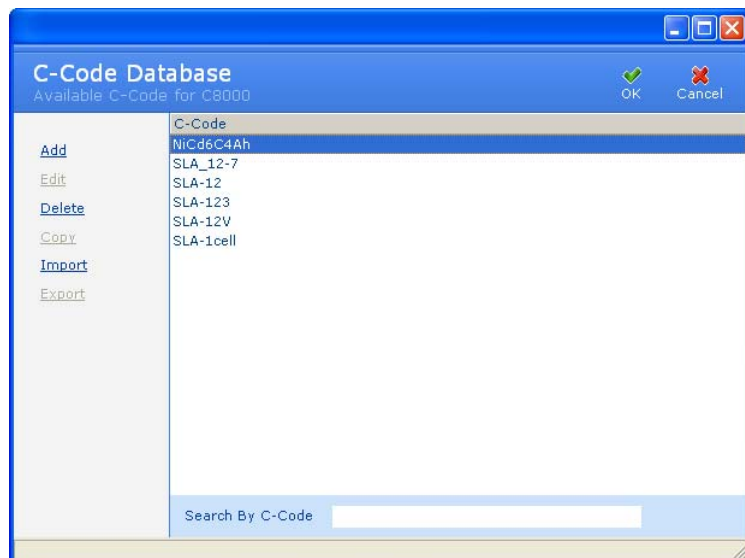


5. Edit the information as required.
6. Click **OK**.

### 3.9.4 Delete a C-Code

To delete a c-code from BatteryLab:

1. From the **Database** menu, click **C-Code**. The **C-Code Database** window appears.



2. Select the c-code to delete.

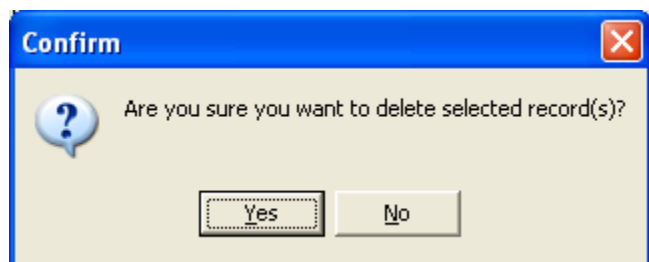
- Click **Delete**. If database security is enabled, the **Password** window appears.



- Enter your password and click **OK**. The **Delete Options** window appears.



- If you select *Delete from BatteryLab* option, the **Confirm** window appears. Click **Yes** to delete the c-code.

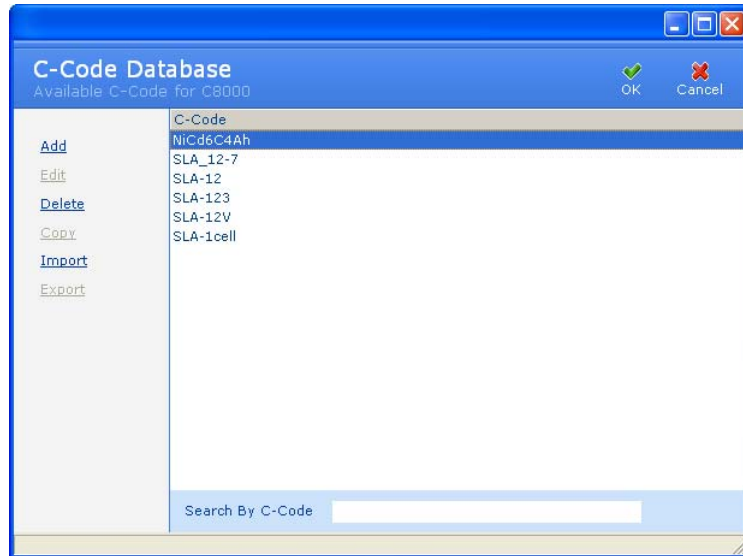


- If you select the *Delete from Connected C8000*, the **Delete C-Code** window appears. The top half of this window lists all connected C8000s while the bottom half of this window lists the c-codes for the selected C8000. Select the c-code to delete and click **Delete**.

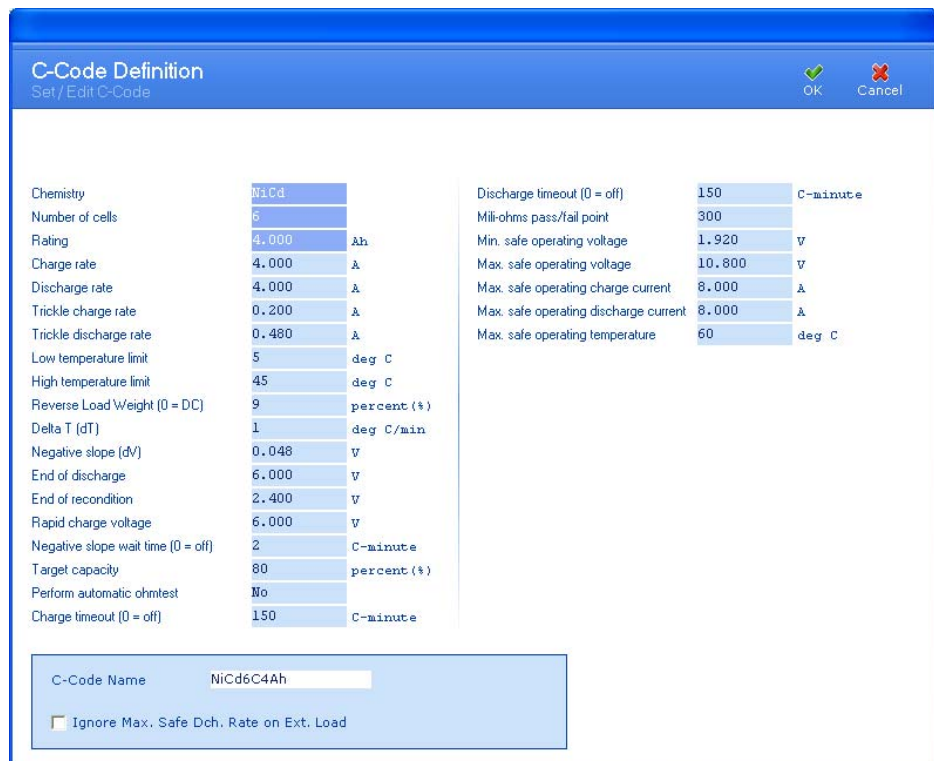
### 3.9.5 Copy a C-Code

To create a c-code based on an existing C-Code:

1. From the **Database** menu, click **C-Code**. The **C-Code Database** window appears.



2. Select the c-code to copy.
3. Click **Copy**. The **C-Code Definition** window appears.

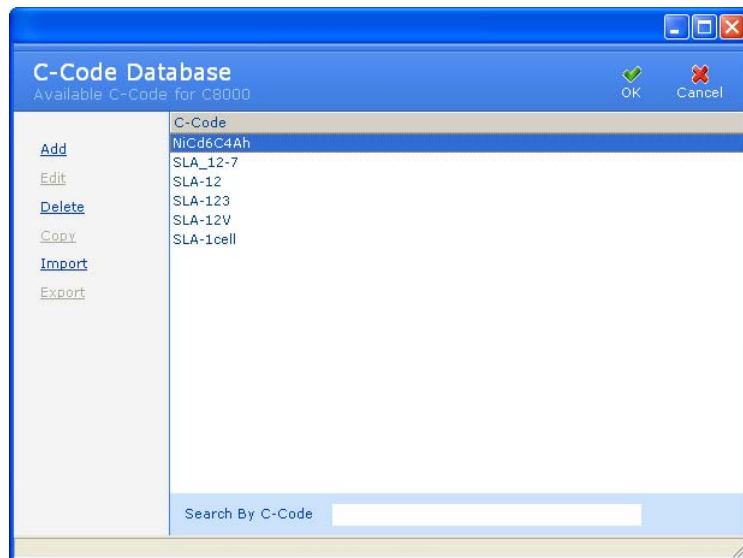


4. Edit the chemistry settings for the c-code, as required.
5. Type a name for the new c-code in the *C-Code Name* field.
6. Click **OK**.

### 3.9.6 Import a C-Code

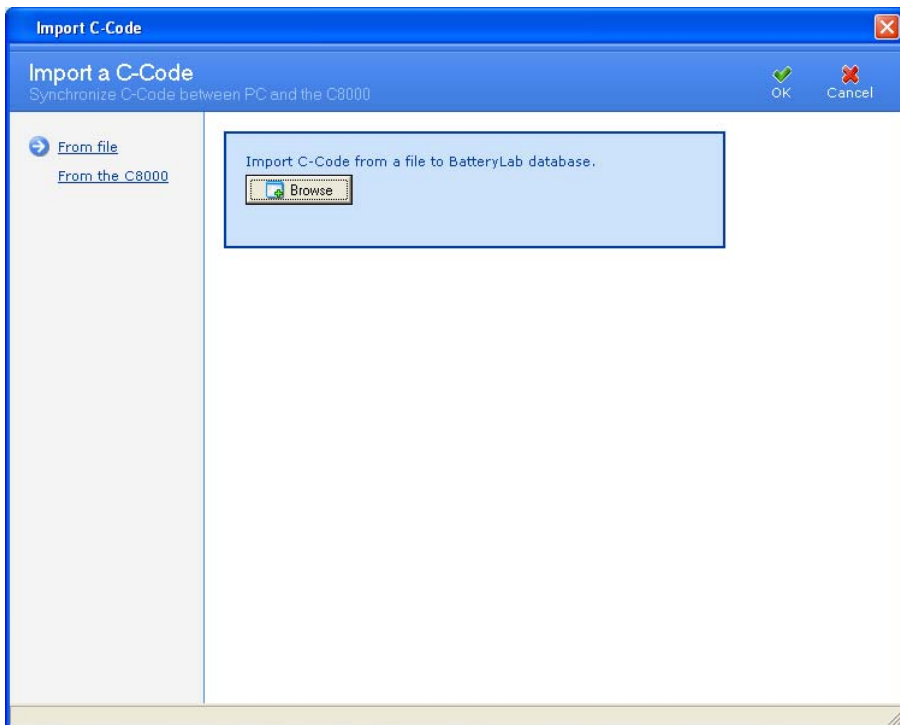
To import a c-code from a file:

1. From the **Database** menu, click **C-Code**. The **C-Code Database** window appears.

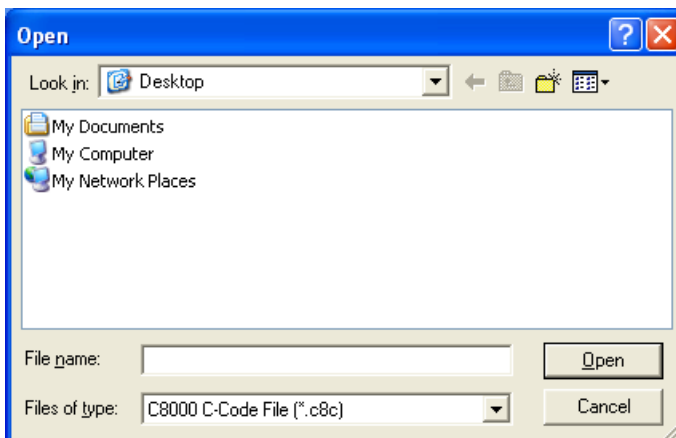




2. Click **Import**. The **Import C-Code** window appears.



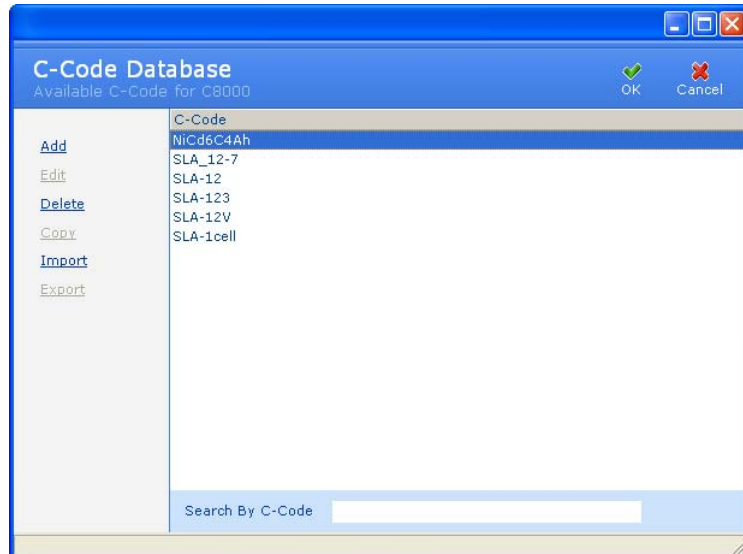
3. Click **Browse**. The **Open** window appears.



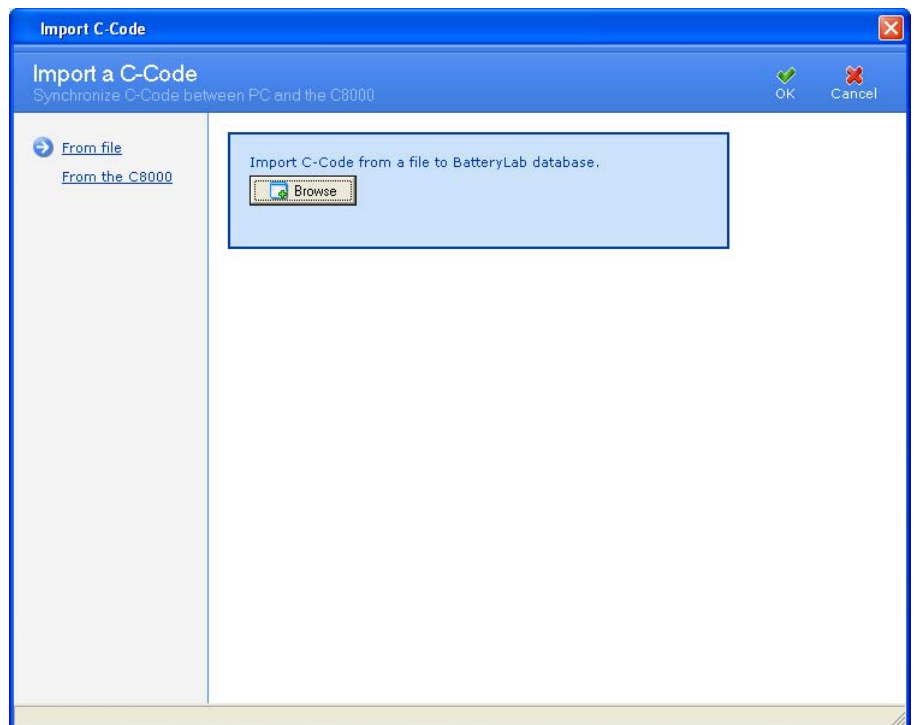
4. Select the file to import and click **Open**. The **Information** window appears, showing the number of c-codes imported. (If the c-code already exists, click **Cancel** to terminate the import process altogether, or **OK** to overwrite the existing c-code. Alternatively, specify a different name for the c-code and click **OK** to import it.) Note that multiple c-codes can exist in one file.

To import a c-code from the C8000:

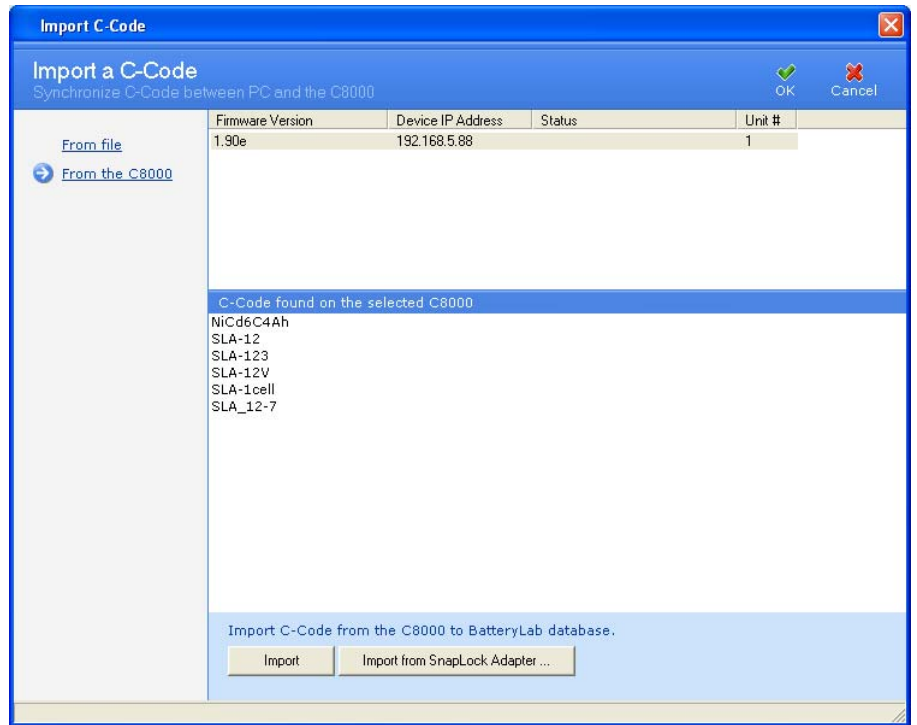
1. From the **Database** menu, click **C-Code**. The **C-Code Database** window appears.



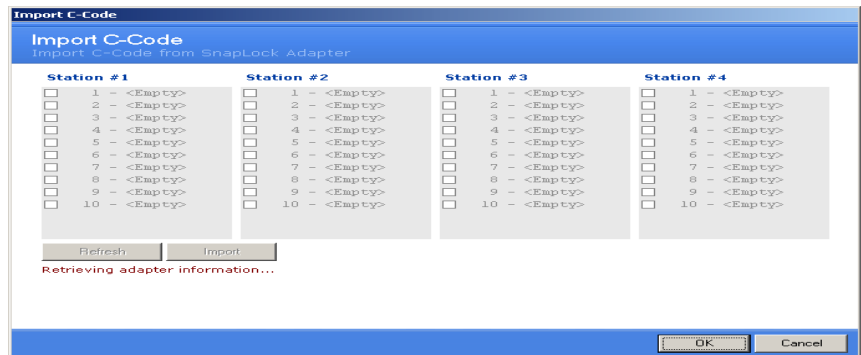
2. Click **Import**. The **Import C-Code** window appears.



3. Click **From the C8000**. The **Import C-Code** window appears.



- 4.
5. Select the C8000 that contains the c-code to import and click **Import** or click **Import from SnapLock Adapter** to see a list of stations the SnapLock/RigidArm Adapter may be attached to.

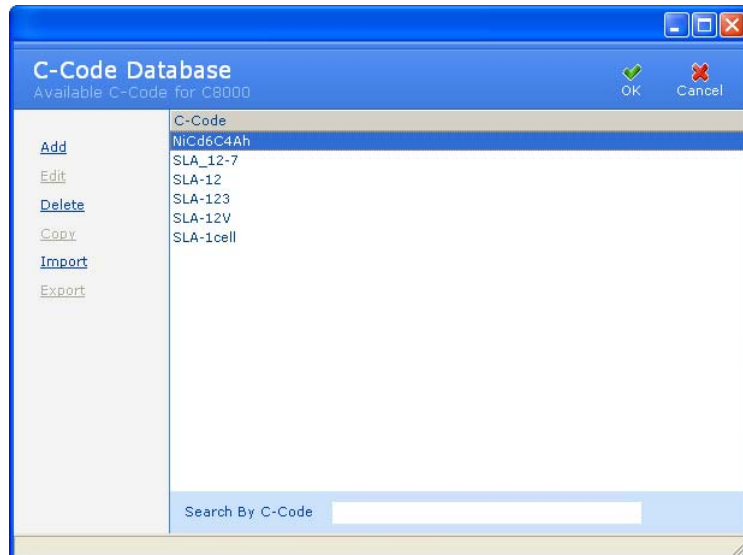


Click **Refresh** to update the list of c-codes from the SnapLock/RigidArm Adapter. Next, select the c-code(s) to download. Click **Import** to transfer the c-code(s) file(s).

### 3.9.7 Export a C-Code

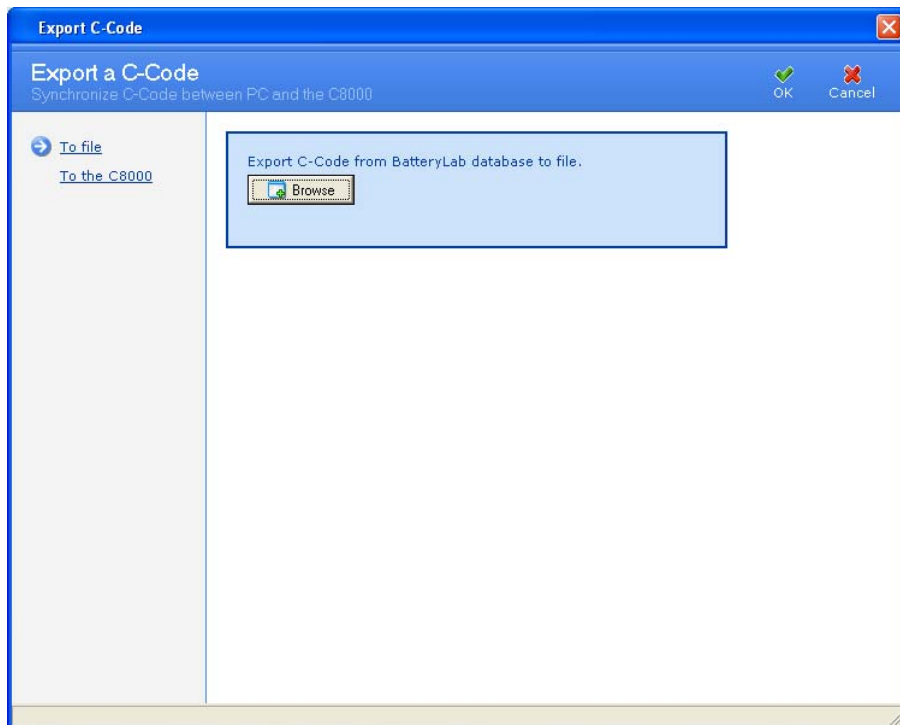
To export c-codes to a file:

1. From the **Database** menu, click **C-Code**. The **C-Code Database** window appears.

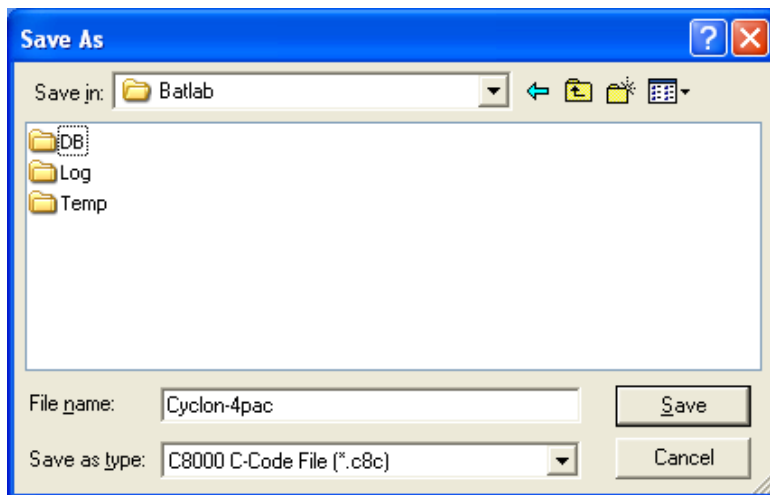


2. Select the c-code to export. Note that multiple c-codes can be exported to the same file.

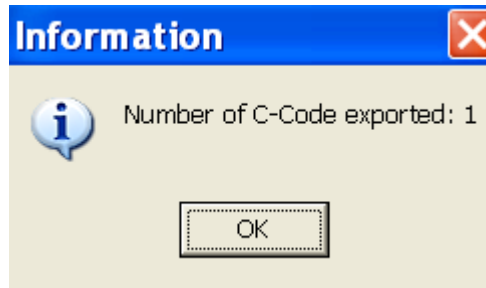
3. Click **Export**. The **Export C-Code** window appears.



4. Click **Browse**. The **Save As** window appears.



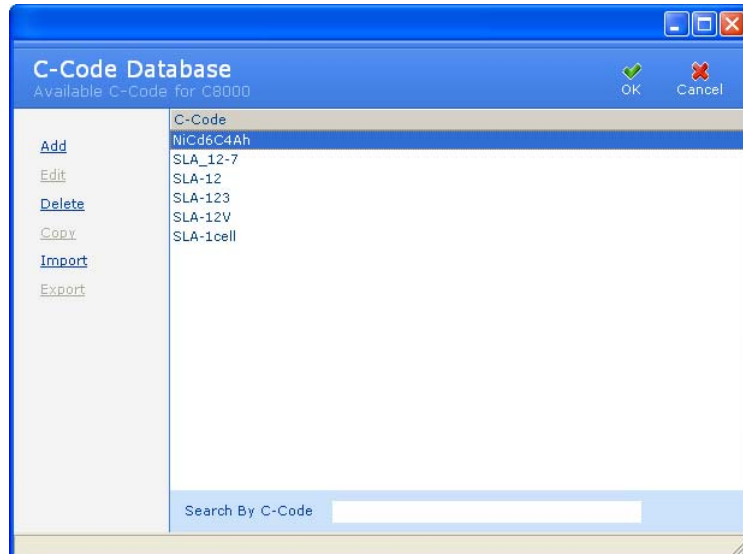
5. Type a name for the file in the *File name* field.
6. Click **Save**. All selected c-codes are saved to the file. An **Information** window appears with the number of C-Codes exported. (If the file already exists, specify a new filename or opt to overwrite the existing file - click **OK**.)



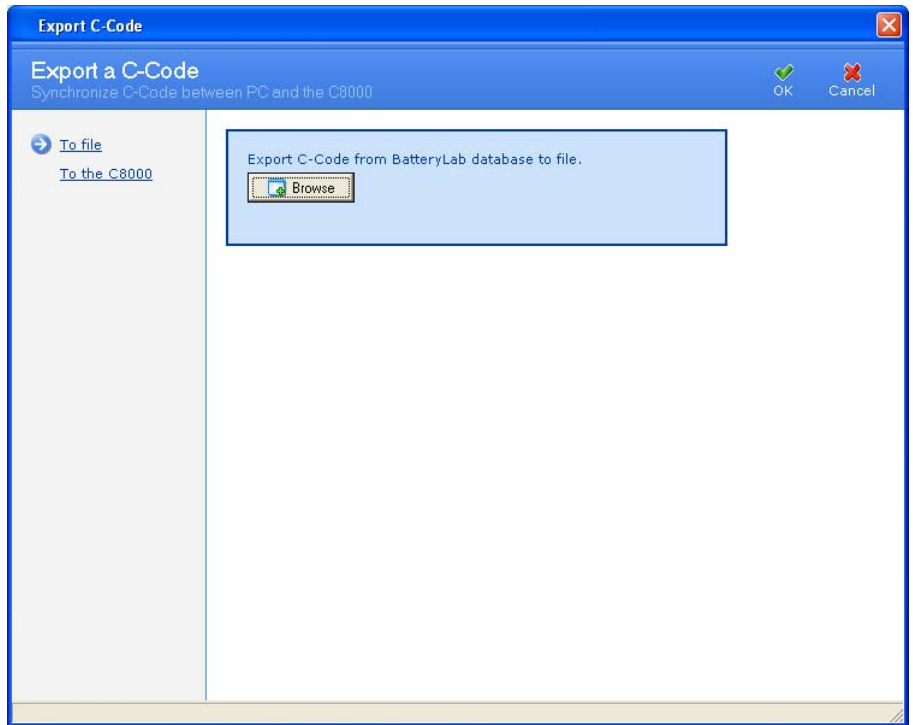
7. Click **OK**.

To export c-codes to the C8000:

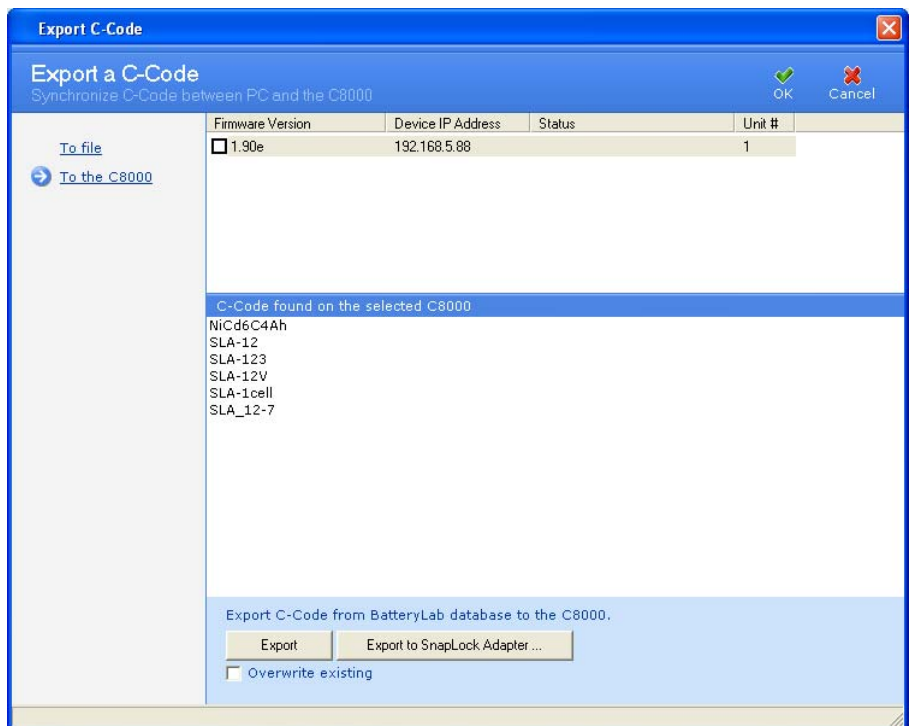
1. From the **Database** menu, click **C-Code**. The **C-Code Database** window appears.



2. Select the c-code(s) to export.
3. Select the C8000 to export the c-codes to and click **Export**. The **Export C-Code** window appears.



4. Click **To the C8000**. The **Import/Export** window appears.



5. Click **Export**. All selected c-codes are exported to the same file. An **Information** window appears with the number of C-Codes exported.

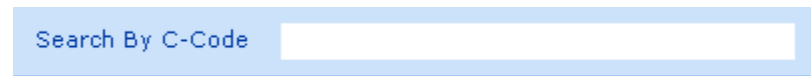


6. Click OK.

---

### 3.9.8 Search for a C-Code

The BatteryLab database may contain hundreds, or even thousands, of c-codes. To find a c-code, click the *Search By C-Code* field to move the cursor to that field.



Next, type the first one or two characters of the c-code to find. As BatteryLab locates the partial c-code, it will highlight the corresponding c-code in the **C-Code Database** window.

---

### 3.9.9 Sort the C-Codes

The BatteryLab database may contain many c-codes. To sort the c-codes in ascending order, click the *C-Code* column in the **C-Code Database** window. Click the column a second time to sort the c-codes in descending order.

---

## 3.10 Programs

The **Program Database** window lists the system and custom programs that are available for the C8000. For each program, the **Program Database** window shows the program's name, the program's type, and whether the program is active. A program contains one or more steps that will be executed in the order specified.

Programs can be added, edited, deleted, copied, imported, or exported. Programs can also be organized in folders.

It is possible to create as many programs as required, but a program cannot exceed 99 steps in length.



The following table provides a description of sample programs to use as a starting point when creating BatteryLab programs to test batteries.

Emergency Lighting Battery Test	<ol style="list-style-type: none"> <li>1. Trickle charge for 24 hours</li> <li>2. Discharge for 15 minutes at @10A</li> <li>3. Charge</li> <li>4. Trickle charge for 24 hours</li> <li>5. Loop to step 1.</li> </ol>
Simulate a battery and solar energy-powered device (such as a radio repeater, weather stations, and so on).	<ol style="list-style-type: none"> <li>1. Charge for 3 hours @ lower current (Sunrise)</li> <li>2. Charge for 6 hours @ higher current (Daytime)</li> <li>3. Charge for 3 hours @ lower current (Sunset)</li> <li>4. Discharge for 12 hours @ constant current (Nighttime)</li> </ol>
Similar to the program above, except connect an external light sensor to one of the auxiliary inputs.	<ol style="list-style-type: none"> <li>1. Charge @ lower current; if analog input &gt;= daytime value, proceed to step 2.</li> <li>2. Charge @ higher current; if analog input &lt; daytime value, proceed to step 3.</li> <li>3. Charge @ lower current; if analog input = nighttime value, proceed to step 4.</li> <li>4. Discharge @ constant current; if analog input &gt; nighttime value, proceed to step 1</li> </ol>

### 3.10.1 Factory Default Programs

The following table describes the C8000 Factory Default programs.

<i>Program</i>	<i>Description</i>
Auto	<b>Function:</b> Exercises batteries to maintain optimum performance. This is the recommended program for routine maintenance of batteries. This test reconditions NiCD and NiMH batteries that do not reach Target Capacity. Li-ion and SLA batteries are not reconditioned, only exercised.

	<p><b>Sequence:</b> The battery is first cycled (charged and then discharged) to determine its true capacity. If NiCD and NiMH batteries do not meet the target capacity at the end of the discharge cycle, they are reconditioned to reduce battery memory. Following recondition, the battery is cycled again to determine the recovered or final capacity. The battery is fully charged when the program completes. SLA and Li-ion batteries are cycled once. If the target capacity is not reached in the first cycle, it is cycled again. Recondition is not performed for Li-ion and SLA batteries.</p> <p><b>Duration:</b> Approximately 2.5 to 10 hours for NiCD and NiMH, 20 to 40 hours for SLA and 6 to 20 hours for Li-ion using default C-Codes.</p>
Charge	<p><b>Function:</b> Fast charge a battery.</p> <p><b>Sequence:</b> A charge cycle is applied to the battery. No capacity readings are taken (capacity is only obtained if there is a discharge cycle). <i>Charge does not perform a full analysis; use the Auto or Prime program to fully diagnose a battery.</i></p> <p><b>Duration:</b> Approximately 1.5 hours for NiCD and NiMH, 10 hours for SLA, and 4 hours for Li-ion using default C-Codes.</p>
Prime	<p><b>Function:</b> Prepares new or stored batteries for use. A new or stored battery may require several charge/discharge cycles to form the cells to achieve peak performance.</p> <p><b>Sequence:</b> The program cycles (discharges and charges) the battery until the difference between capacities from one cycle to the next is less than 5%. Up to four cycles if the 5% capacity difference is not reached. This allows for batteries that cannot accept a full charge on the first cycle. If the battery is fully discharged, the program starts with a charge. No reconditioning is applied. Some batteries may require several Prime cycles to fully form the cells.</p> <p><b>Duration:</b> Approximately 5 to 10 hours for NiCD and NiMH, from 40 to 80 hours for SLA, from 12 to 25 hours for Li-ion using default C-Codes.</p>
SelfDchg (Self Discharge)	<p><b>Function:</b> Identifies the self-discharge or the amount of charge a battery loses if it is left alone for a period of time. The standard time is 24 hours.</p> <p><b>Sequence:</b> The battery is discharged for 10-minutes before charged and discharged to obtain its first capacity. The battery is then charged and left for a 24-hour rest period. During this time, the battery loses energy through self-discharge. After 24 hours, the battery is discharged to determine the second capacity. The difference between the second and first capacity is the self-discharge rate.</p> <p><b>Duration:</b> Approximately 30 hours for a NiCD battery using default C-Codes.</p>

<p>Lifecycle</p>	<p><b>Note:</b> Lifecycle is a “destructive” test that continuously cycles a battery until a failure occurs. Do not run this program on a battery that needs to be used after the program completes.</p> <p><b>Function:</b> Determines total battery life by the number of cycles. Checks whether the battery meets the standard life for its chemistry. This is an accelerated aging test that is designed to “destroy” the battery.</p> <p><b>Sequence:</b> The battery is charged and discharged continuously until the battery fails (i.e. battery capacity falls below target capacity) or the maximum number of cycles has been reached.</p> <p><b>Duration:</b> Approximately one month or more, depending on the chemistry. Batteries should provide the number of cycles as specified by the manufacturer. Typically, with a target capacity of 80%, NiCD batteries should provide about 1500 cycles, NiMH 500 cycles, Li-ion 500 cycles, and SLA 300 cycles.</p>
<p>DchgOnly (Discharge Only)</p>	<p><b>Function:</b> The DchgOnly program determines the residual capacity of a battery, prepares batteries for storage, and checks battery performance under load. To determine battery capacity, fully charge the battery using the <b>Charge</b> program before running the <b>Discharge only</b> program.</p> <p><b>Sequence:</b> The battery is discharged until its voltage reaches the END OF DISCHARGE setting in the C-Code and the battery capacity is measured. If the battery is partially discharged, the capacity may be lower than the target capacity. This may give a Fail Code 115 or 116. The battery is not necessarily poor.</p> <p><b>Duration:</b> Approximately 1 hour for a NiCD battery discharged at default C-Code settings.</p> <p><b>Note:</b> Smart batteries (often used in laptops) should not be stored in a fully discharged state. If the battery’s voltage drops below the level required by the processor within the battery, information can be lost. In some cases, this data loss can leave the battery permanently unusable.</p>
<p>ExtPrime (Extended Prime)</p>	<p><b>Function:</b> Exercises a battery that has been in storage or unused for three months or more.</p> <p><b>Sequence:</b> The battery is charged for 16 hours on the TRICKLE CHARGE setting in the C-Code. The battery is then cycled (charged and discharged) up to five times until the difference between the capacities achieved from one cycle to the next is less than 5%.</p> <p><b>Duration:</b> Approximately 24 hours for a NiCD battery charged and discharged at 1.00C.</p>
<p>OhmTest</p>	<p><b>Function:</b> This program is similar to the IEC “DC” method of resistance measurement. It is recommended that the battery have a</p>

	<p>high state of charge (i.e. fully charged) to provide accurate values. If battery SoC is less than 50%, OhmTest readings are less consistent. Low state of charge may produce poor or low values. It provides an estimate of the battery capability to handle load. If using a battery capacity rated under 300mah, use the IMPEDANCE program on Channel 1.</p> <p><b>Sequence:</b> The program tests the battery's resistance and compares the result with the battery's OHMTEST SETPOINT. If the result is above this threshold, the program fails the battery.</p> <p><b>Duration:</b> 15 seconds for all chemistries.</p>
Impedance	<p><b>Function:</b> This program is similar to the IEC "AC" method of resistance measurement. It is recommended that the battery have a moderate to high state of charge to provide accurate values. Very low or very high states of charge may produce poor values. It provides an estimate of the battery capability to handle load. Note that the "Impedance" program can only be run on Channel #1.</p> <p><b>Sequence:</b> The program tests battery resistance and compares the result with the battery's OHMTEST SETPOINT. If the result is above this threshold, the program fails the battery.</p> <p><b>Duration:</b> 30 to 60 seconds for all chemistries.</p>
Runtime	<p><b>Function:</b> Often referred to as a "5-5-90" test, the RunTime program simulates field application with three load currents and time intervals.</p> <p><b>Sequence:</b> The battery is charged. The program then repeatedly runs the three different loads until the battery is fully discharged. The Load algorithm for the loads are 1 minute at 100% then 1 minute at 50% and 18 minutes at 10% of the Discharge Current Specified in the C-code, (i.e. The end-of-discharge setting in the C-Code is reached). A full charge is then applied to complete the program.</p> <p><b>Duration:</b> Approximately 8 - 10 hours for a NiCD battery using default C-Codes.</p>
GSM	<p><b>Function:</b> Similar to the RunTime program, but uses a simulated GSM discharge pulse to determine the battery's "Talk Time".</p> <p><b>Sequence:</b> The battery is charged. The program then discharges the battery using the GSM discharge pulse until it is fully discharged (i.e. The end-of-discharge setting in the C-Code is reached). A full charge is then applied to complete the program.</p> <p><b>Duration:</b> Approximately 8 - 10 hours for a NiCD battery using default C-Codes.</p>
CDMA	<p><b>Function:</b> Similar to the RunTime program, but uses a simulated CDMA discharge pulse to determine the battery's "Talk Time".</p>

	<p><b>Sequence:</b> The battery is charged. The program then discharges the battery using the CDMA discharge pulse until it is fully discharged (i.e. The end-of-discharge setting in the C-Code is reached). A full charge is then applied to complete the program.</p> <p><b>Duration:</b> Approximately 8 – 10 hours for a NiCD battery using default C-Codes.</p>
Boost	<p><b>Function:</b> Reactivates batteries with open or shorted protection circuits or with voltage so low that the Cadex analyzer does not recognize them or gives a ‘Shorted’ (Code 121) message when they are inserted in Battery Adapters.</p> <p><b>Sequence:</b> The battery is trickle-charged for three minutes at 100mA. Look for stable current and voltage readings during the Boost program. If they are intermittent, the battery may be poorly connected, battery protection circuit may be damaged or the battery is inoperable. Typically, normal battery operation should be possible after the battery has reached more than 0.30V/cell on NiCD and NiMH batteries and more than 2.5V for Li-ion batteries. If Boost does not raise the voltage to detectable levels, apply the Boost program again.</p> <p><b>Duration:</b> 3 minutes (user may repeat if unsuccessful).</p> <p><b>Warning: Failure to follow these precautions may result in serious damage to the Cadex unit and/or the battery:</b></p> <p><b>The Boost program overrides some of the analyzer’s built-in safety measures to recognize a battery. Do not attempt to Boost a battery if the polarity, chemistry, voltage, and capacity (mAh) are not known. Ensure that battery polarity is correct before attempting to run Boost.</b></p>
BatteryInfo	<p><b>Function:</b> For SM-Bus batteries only. Allows the SM-Bus information from a battery to be viewed before actually starting a program.</p> <p><b>Sequence:</b> Reads the SM-Bus data from the battery and sends the information to BATLAB. <b>Important Note:</b> Information is not shown on the screen of the C8000.</p> <p><b>Duration:</b> 30 seconds to 2 minutes, depending of the battery’s communication rate.</p>
Charge-1	<p><b>Function:</b> For SM-Bus batteries only. Performs a SM-Bus “Level-1” charge. This is similar to the standard “Charge” program, but also monitors the SM-Bus status and alarm flags during the charge.</p> <p><b>Sequence:</b> A charge cycle is applied to the battery. No capacity readings are taken (capacity is only obtained if there is a discharge). <i>Charge does not perform a full analysis; use the Auto or Prime program to fully diagnose a battery.</i></p> <p><b>Duration:</b> Approximately 1.5 hours for NiCD and NiMH, 10 hours</p>

	for SLA, and 4 hours for Li-ion using default C-Codes.
SMB-DChg	<p><b>Function:</b> For SM-Bus batteries only. This is similar to the standard “DchgOnly” program, but also monitors the SM-Bus status and alarm flags during the discharge.</p> <p><b>Sequence:</b> The battery is discharged until its voltage reaches the END OF DISCHARGE setting in the C-Code.</p> <p>The battery capacity is measured during a discharge and if the battery is partially discharged, the capacity may be lower than the target capacity. This may give a Fail Code 115 or 116. The battery is not necessarily poor.</p> <p><b>Duration:</b> Approximately 1 hour for a NiCD battery discharged at default C-Code settings.</p>
FG-Calibrate	<p><b>Function:</b> For SM-Bus batteries only. This program cycles the battery to allow the SM-Bus fuel gauge to be recalibrated.</p> <p><b>Sequence:</b> Performs a full charge, full discharge, and a final full charge cycle. The SM-Bus status and alarm flags are monitoring while the program is running.</p> <p><b>Duration:</b> Approximately 2.5 to 10 hours for NiCD and NiMH, 20 to 40 hours for SLA and 6 to 20 hours for Li-ion using default C-Codes.</p>

---

### **3.10.2 A Custom-Program Example**

The following is a custom-program intended to test the performance of a solar-charged battery operating over a 10-day period.

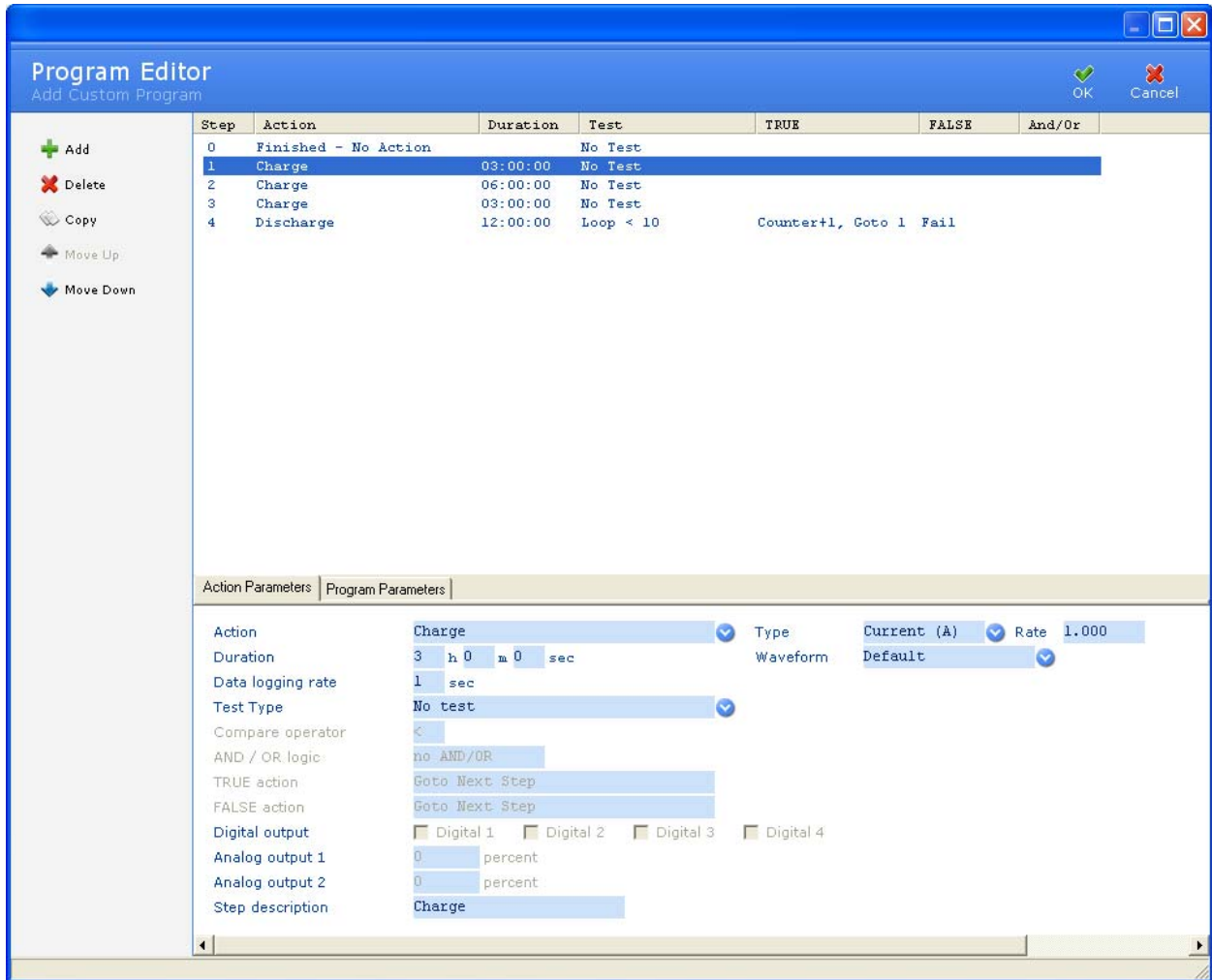
The battery charges for 3 hours at low current simulating early morning sun.

The battery charges for 6 hours at a higher current simulating mid-day sun.

The battery charges for 3 hours at low current simulating evening sun.

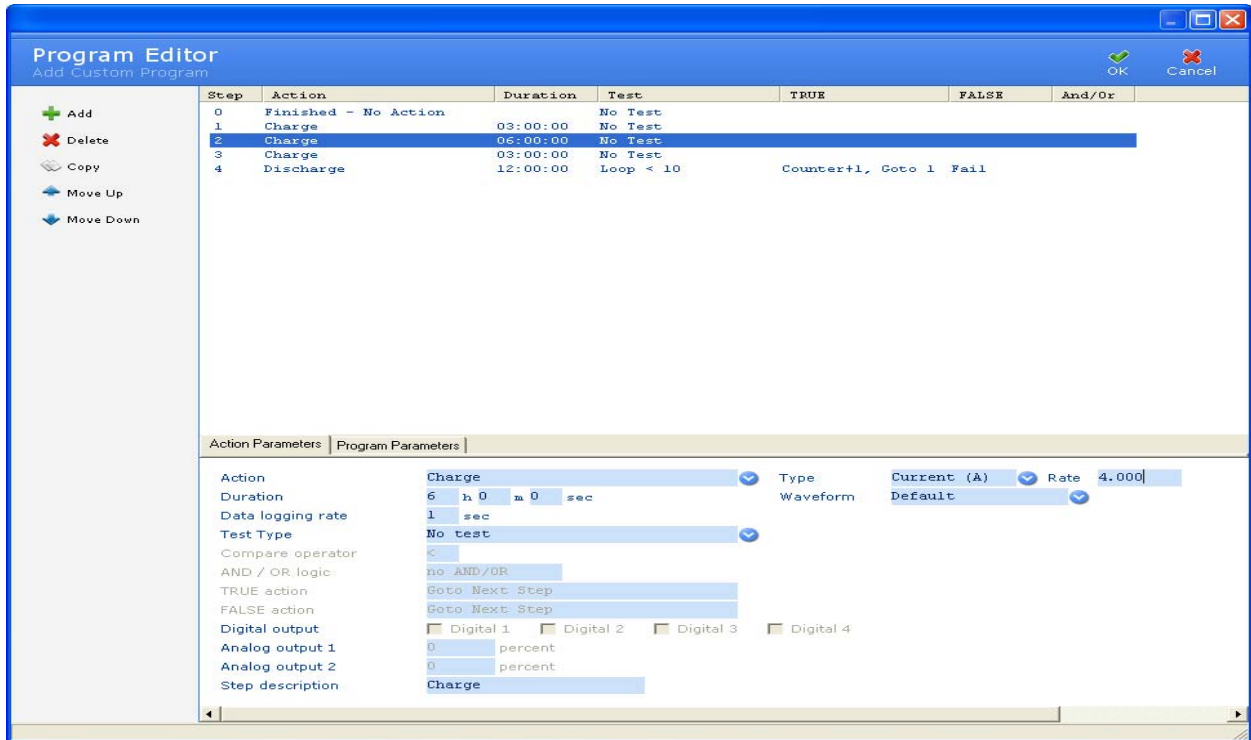
The battery is discharged at a constant current to simulate energy consumption.

The process is repeated 10 times.

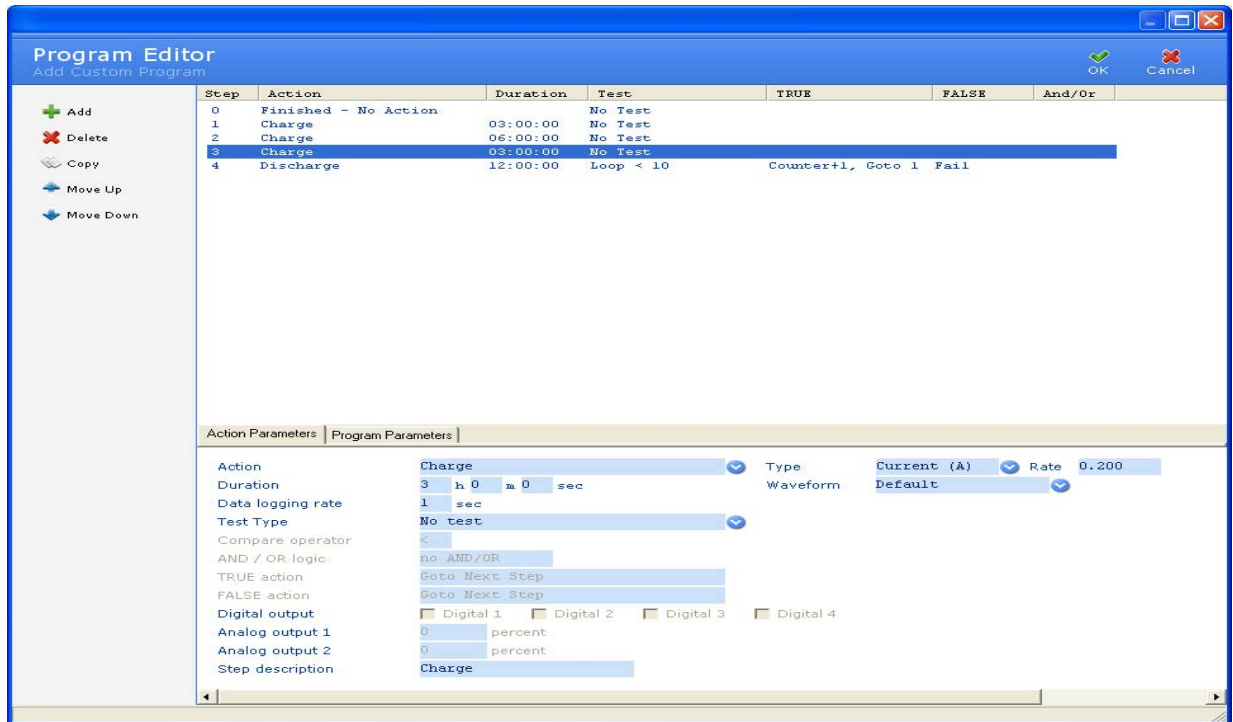


**Step 1 - charge at lower current for 3 hours**

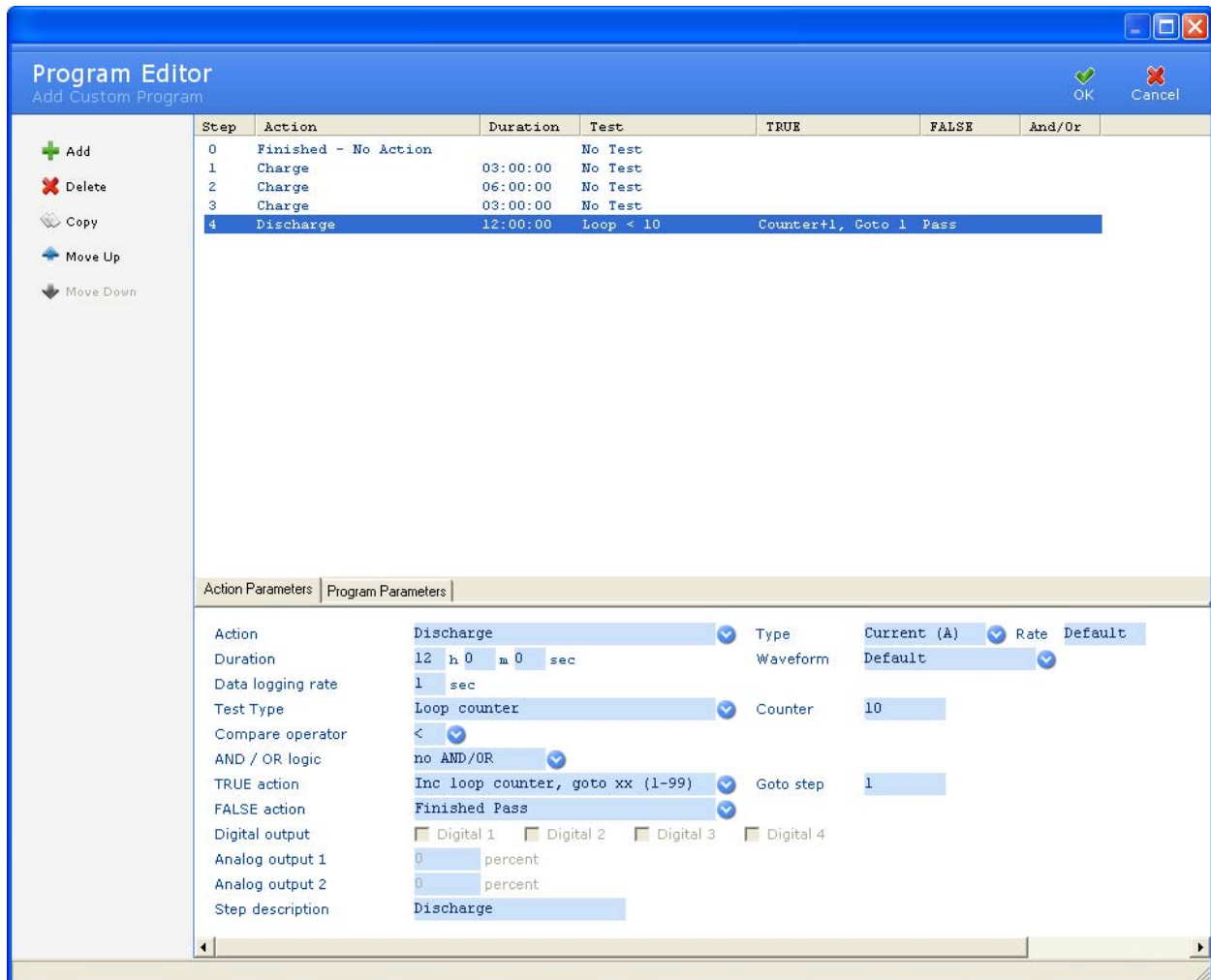




Step 2 - charge at higher current for 6 hours



Step 3 - charge at lower current for 3 hours



#### Step 4 - discharge at constant current for 12 hours

At the end of Step 4 there is a Loop Counter test. If the loop counter is 5 or more the test finishes; otherwise, the test increments the loop counter and jumps to Step 1.

### 3.10.3 A Custom-Program with Thermal Chamber Example

The following is a custom-program intended to test the performance of a solar-charged battery operating over a 10-day period in an environment similar to the summer months.

The battery is saturated at a temperature (13°C) equivalent to the early morning, before a sunrise for 4 hours and 30 minute.

The environmental temperature is increased to 25°C over a 3-hour period, while the battery charges at low current simulating early morning sun.

The battery is then allowed to rest for 30 minutes, simulating the sun being covered/blocked and no charge applied.

The environmental temperature is then increased to 35°C over a 6-hour period, while the battery charges at higher current simulating the mid-day sun.

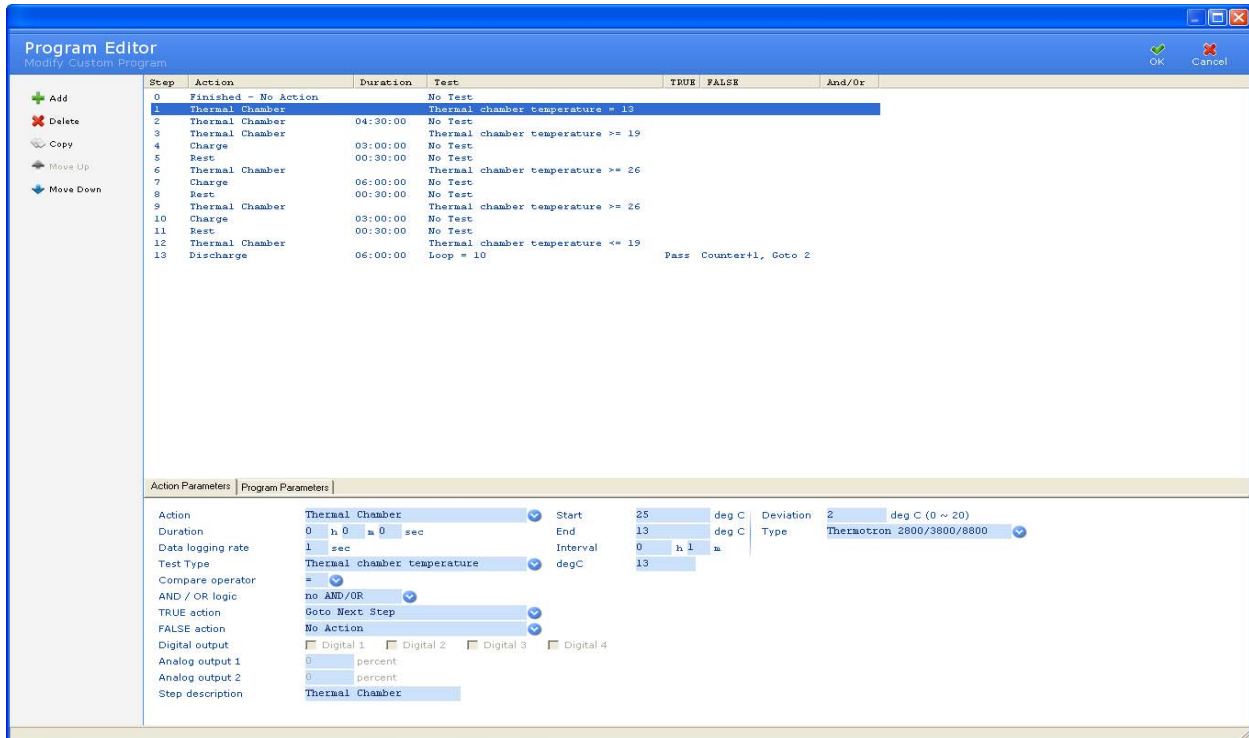
The battery is then allowed to rest for 30 minutes, simulating the sun being covered and no charge applied.

The environmental temperature is decreased to 20°C over a 3-hour period, while the battery charges at low current simulating early evening sun.

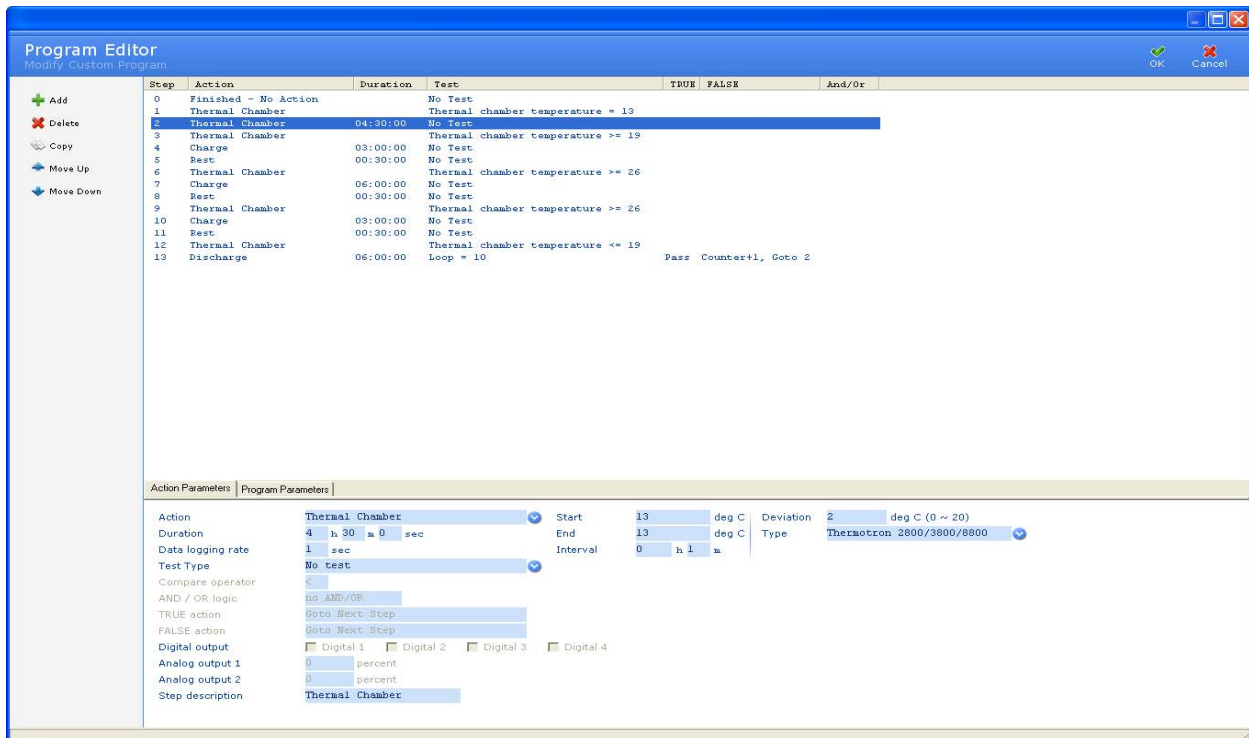
The battery is then allowed to rest for 30 minutes, simulating the low solar power and no charge applied.

The environmental temperature is decreased to 13°C over a 6-hour period, while the battery is discharged at a constant current to simulate energy consumption, during the night

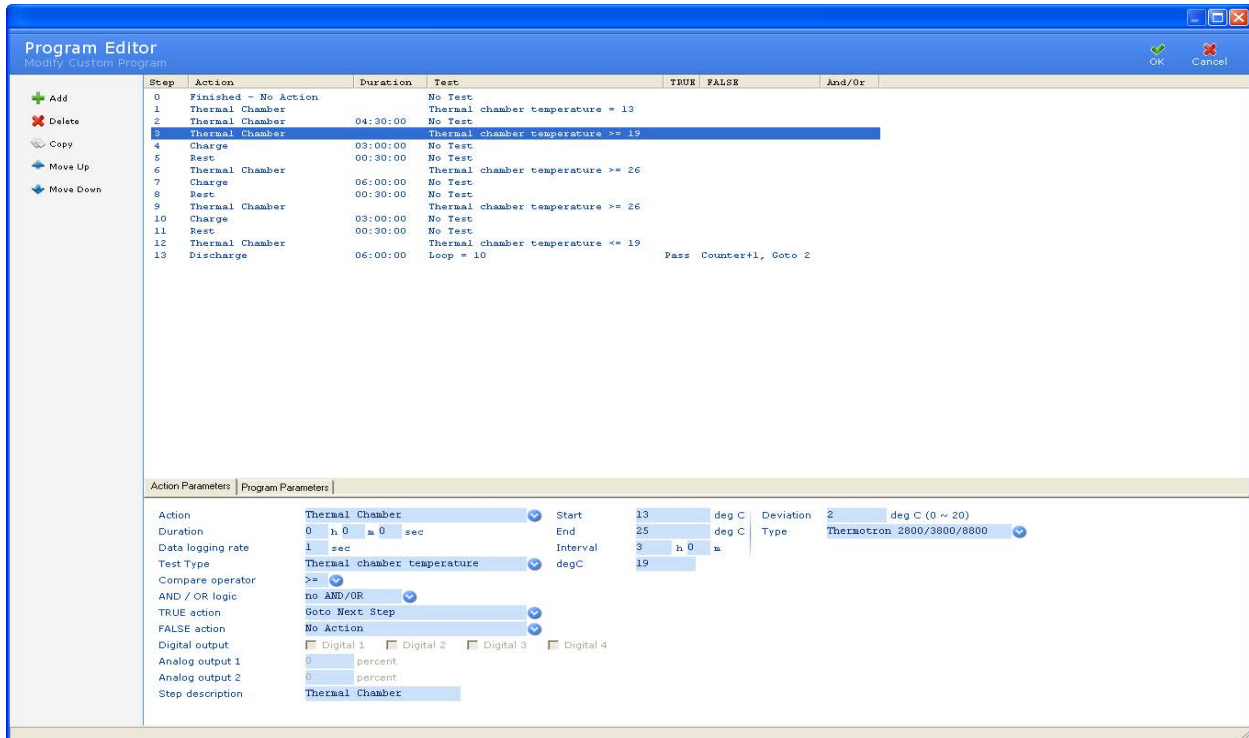
The process is repeated 10 times.



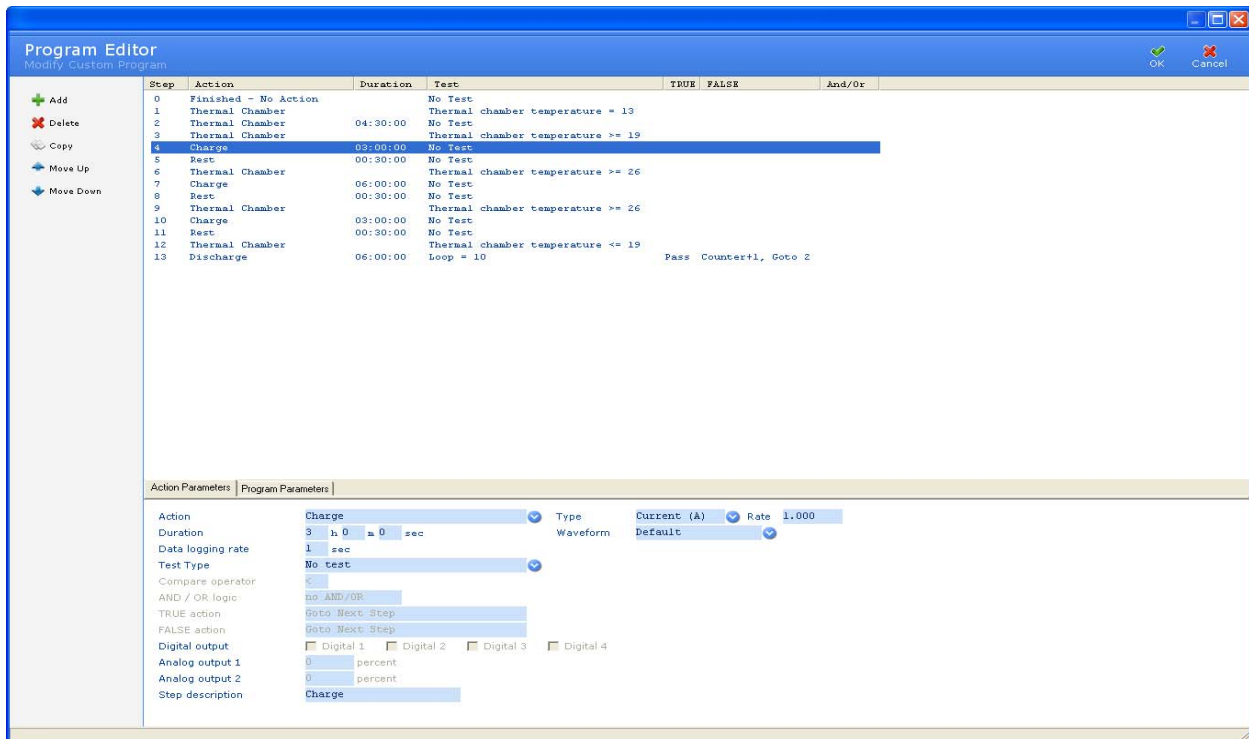
Step 1 – Environment is configured to starting temperature



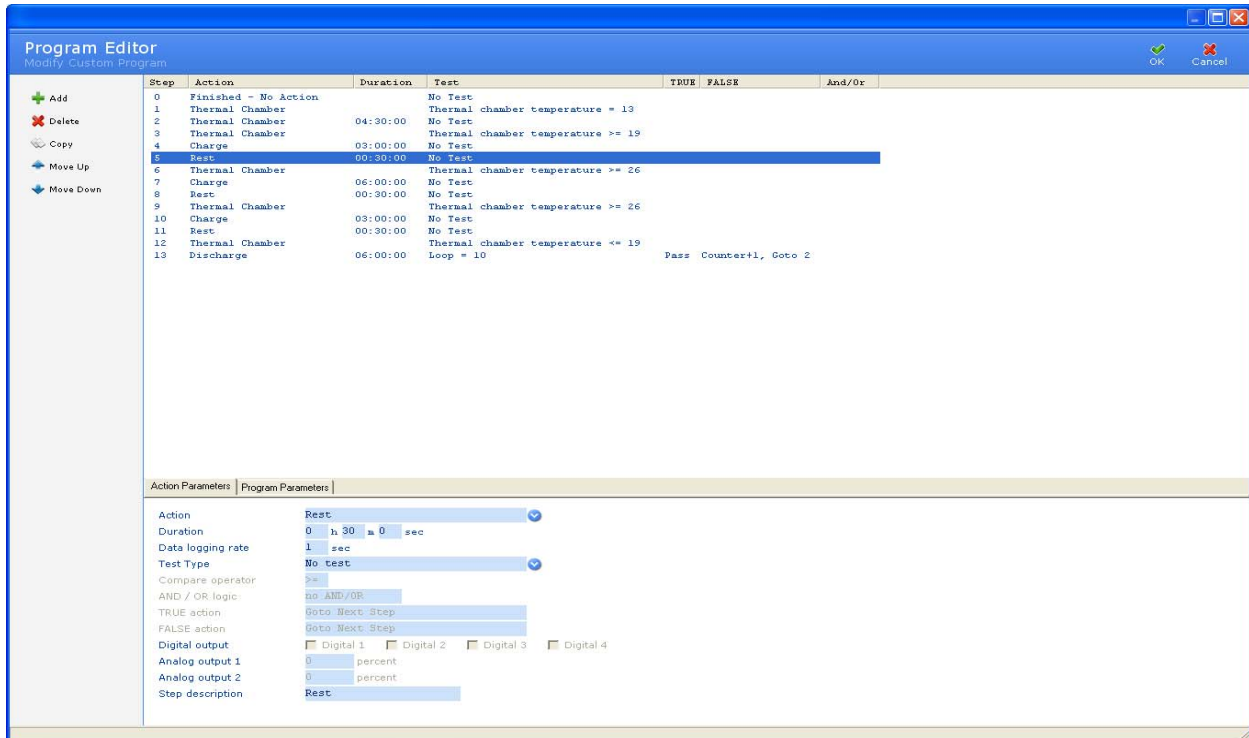
Step 2 – Battery is saturated in the early morning environment



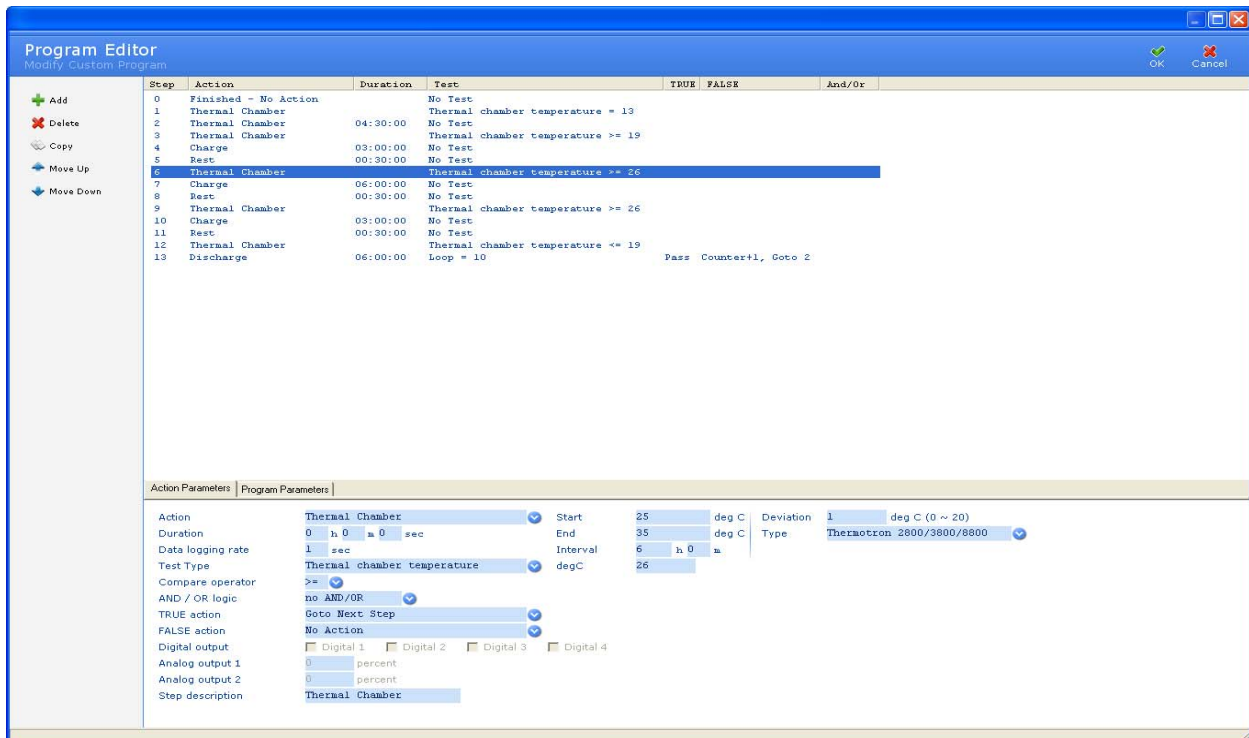
**Step 3 – Environmental Temperature is increased over a 3-hour period.**



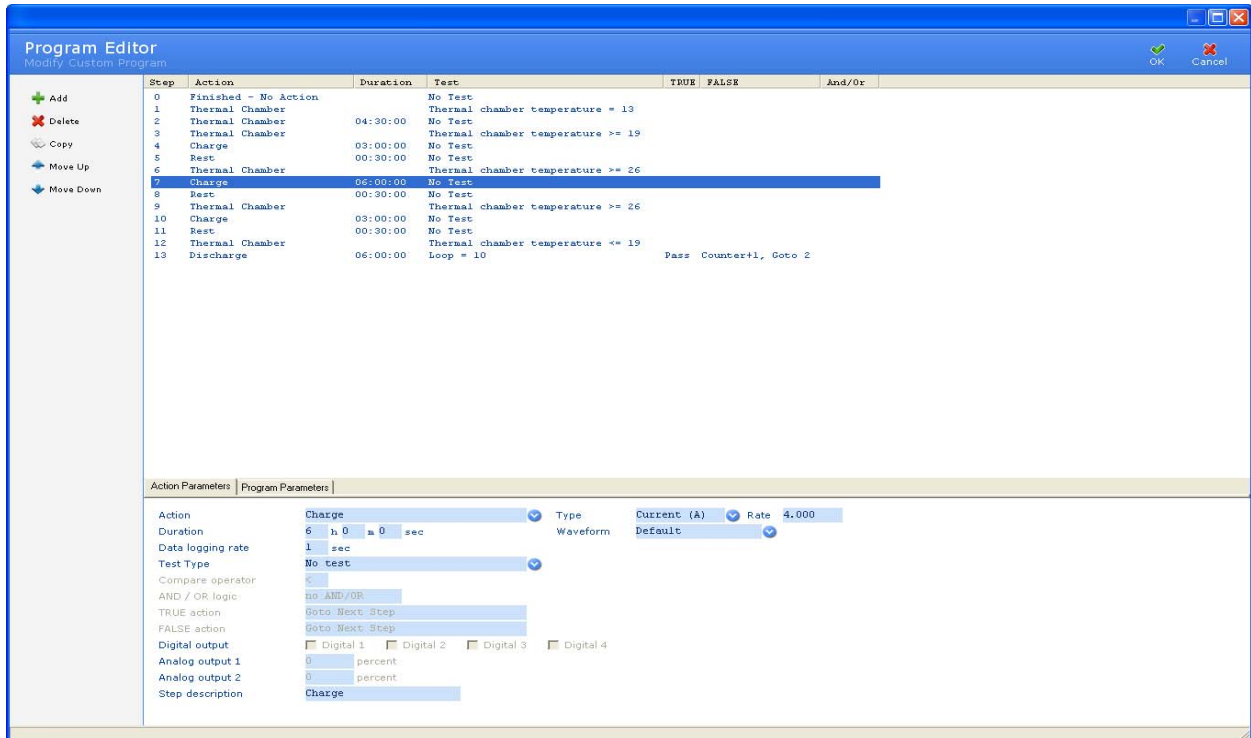
**Step 4 - charge at lower current for 3 hours during the temperature rise**



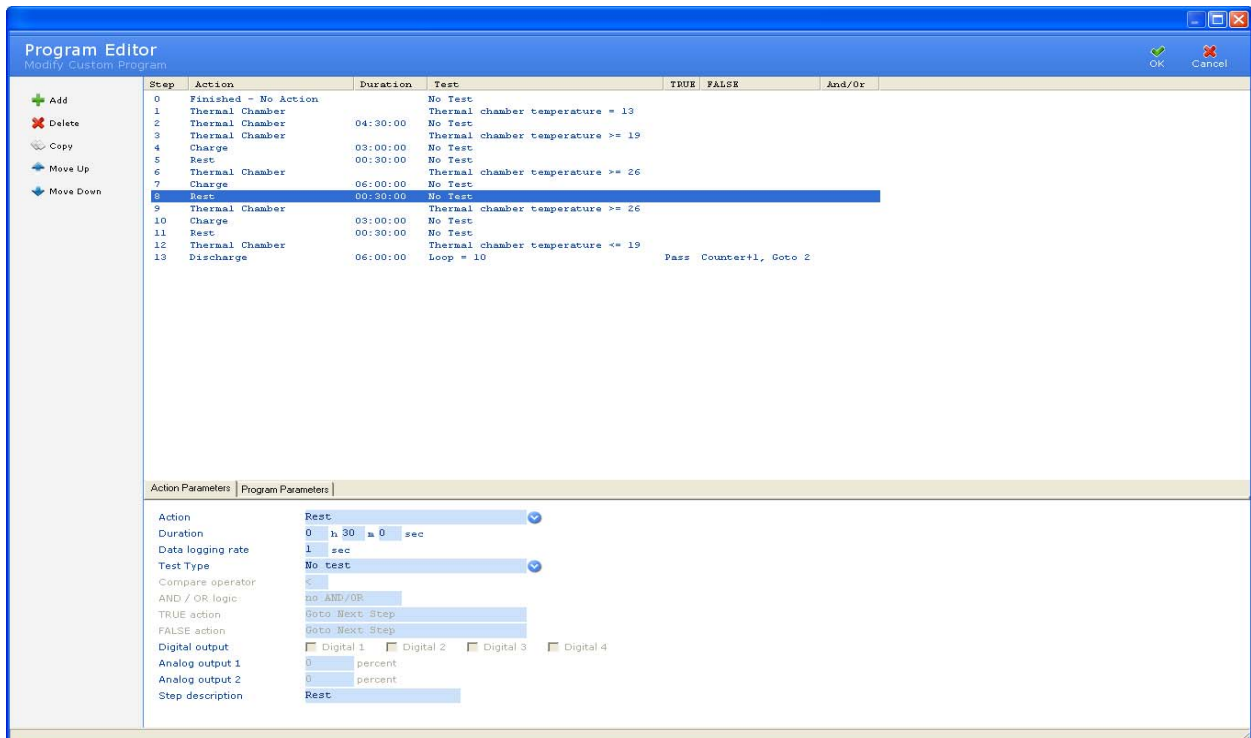
Step 5 – Battery is Rested for 30 minutes



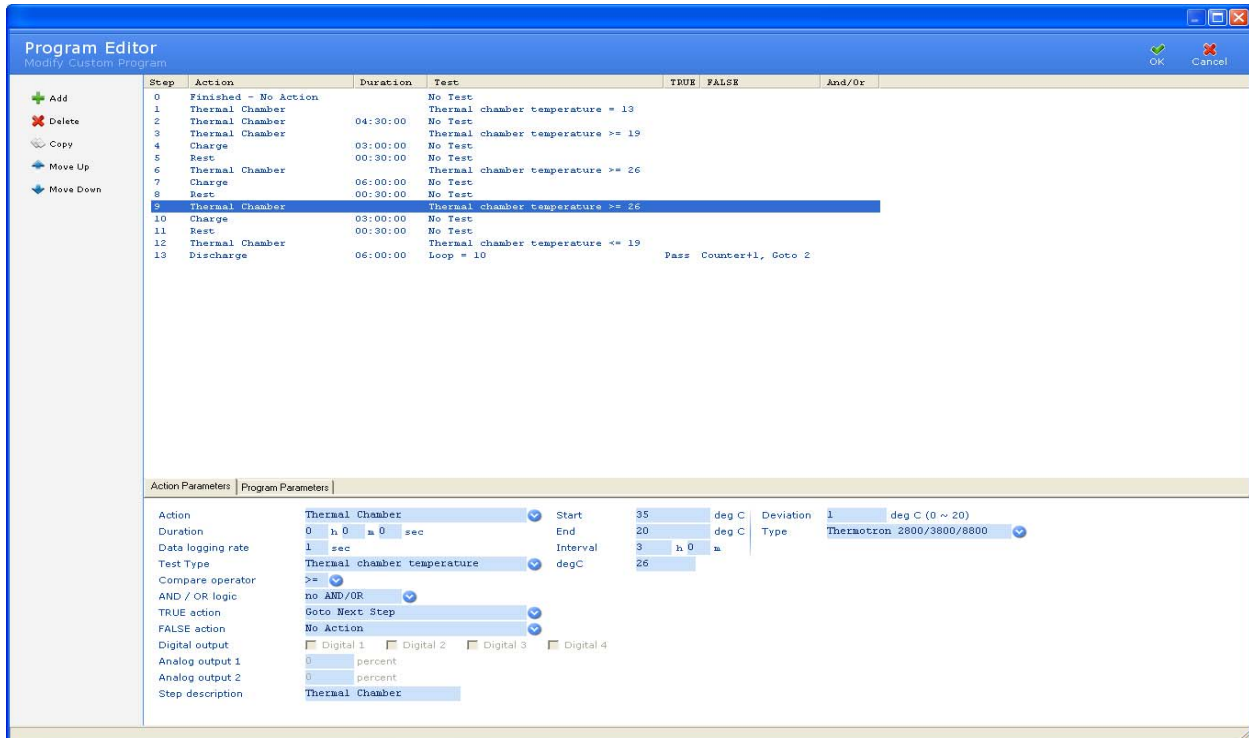
Step 6 – Environmental temperature is increased



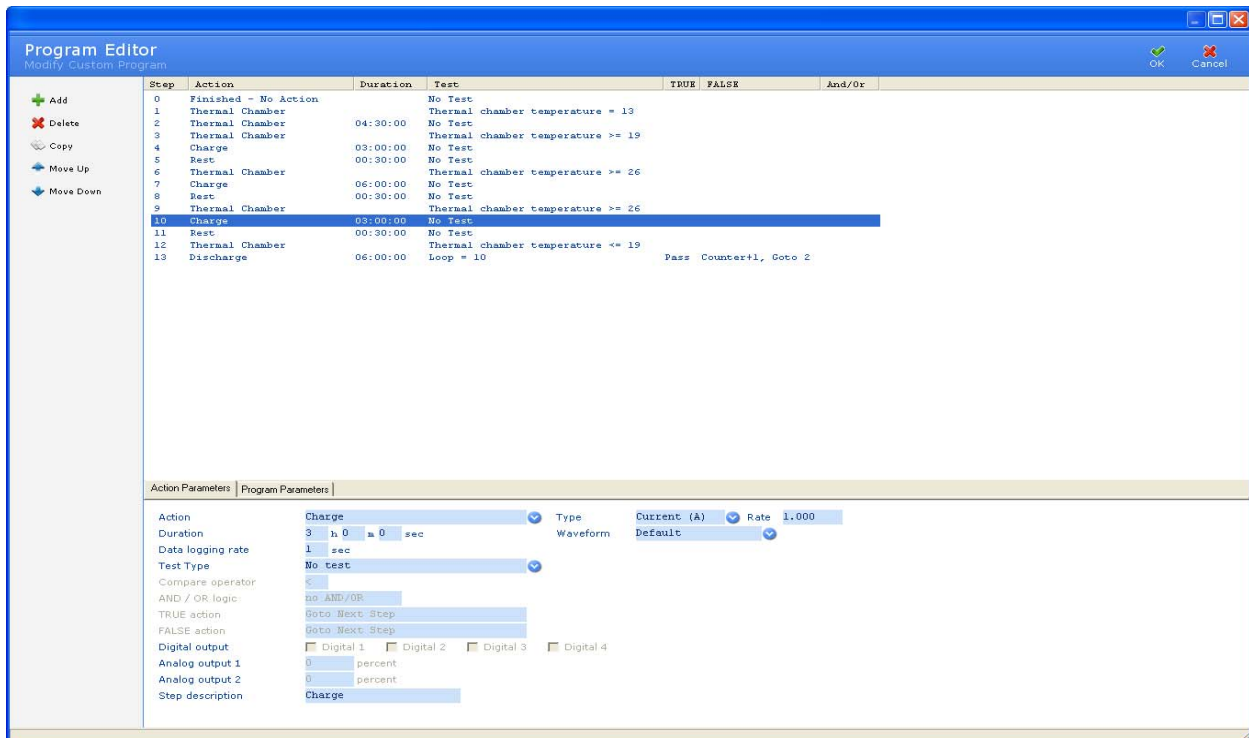
**Step 7 – charge at high current for 6 hours during the temperature rise**



**Step 8 – Battery is Rested for 30 minutes**

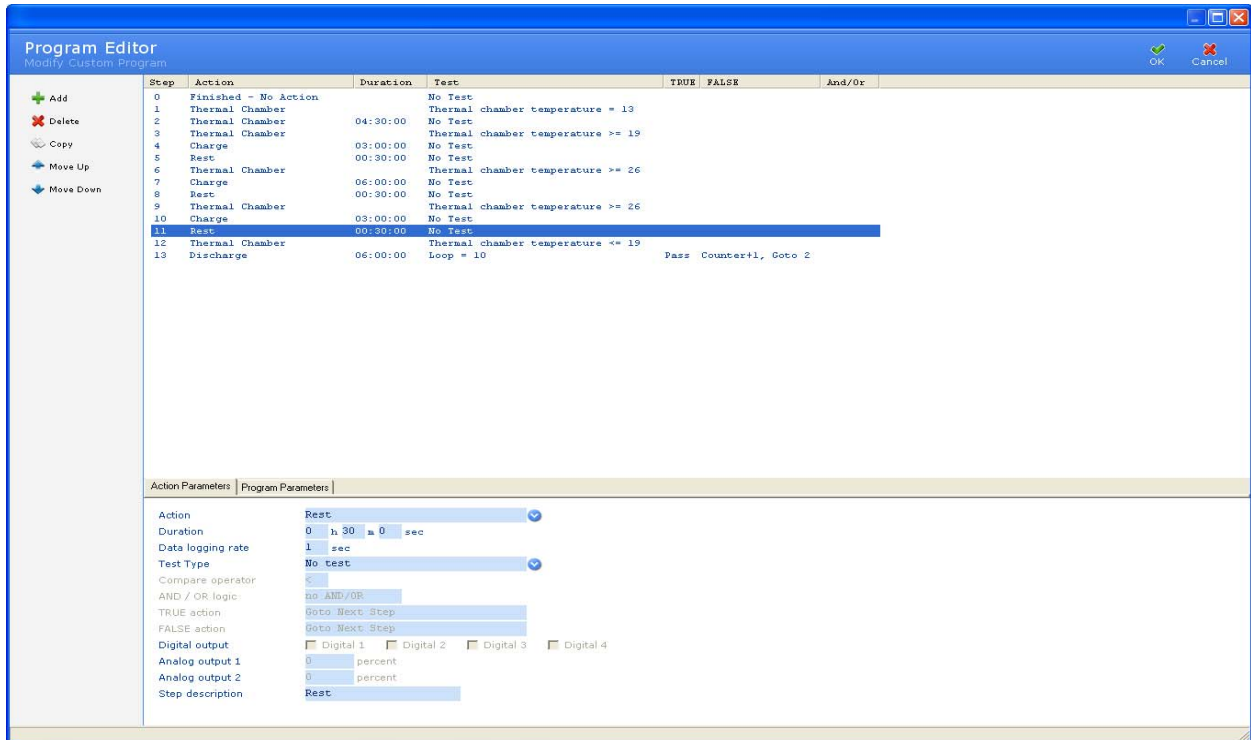


**Step 9 – Environmental temperature is decreased**

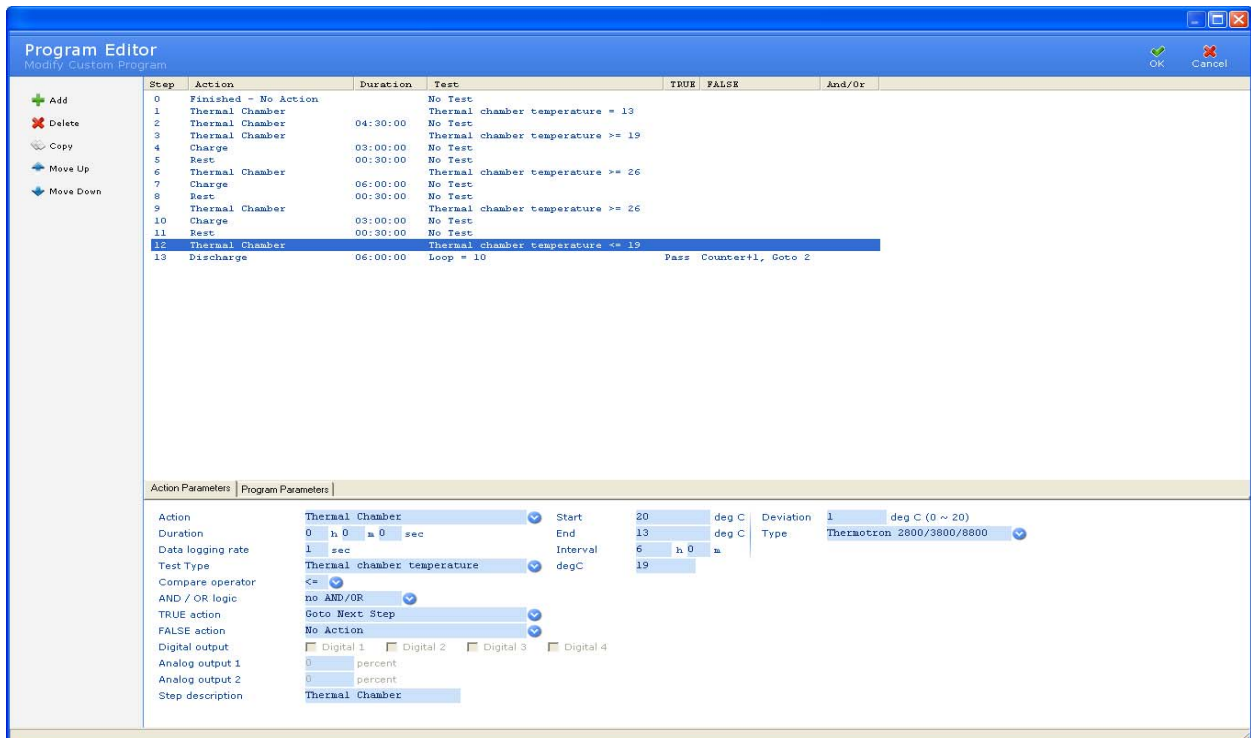


**Step 10 – charge at low current for 3 hours during the temperature decrease.**

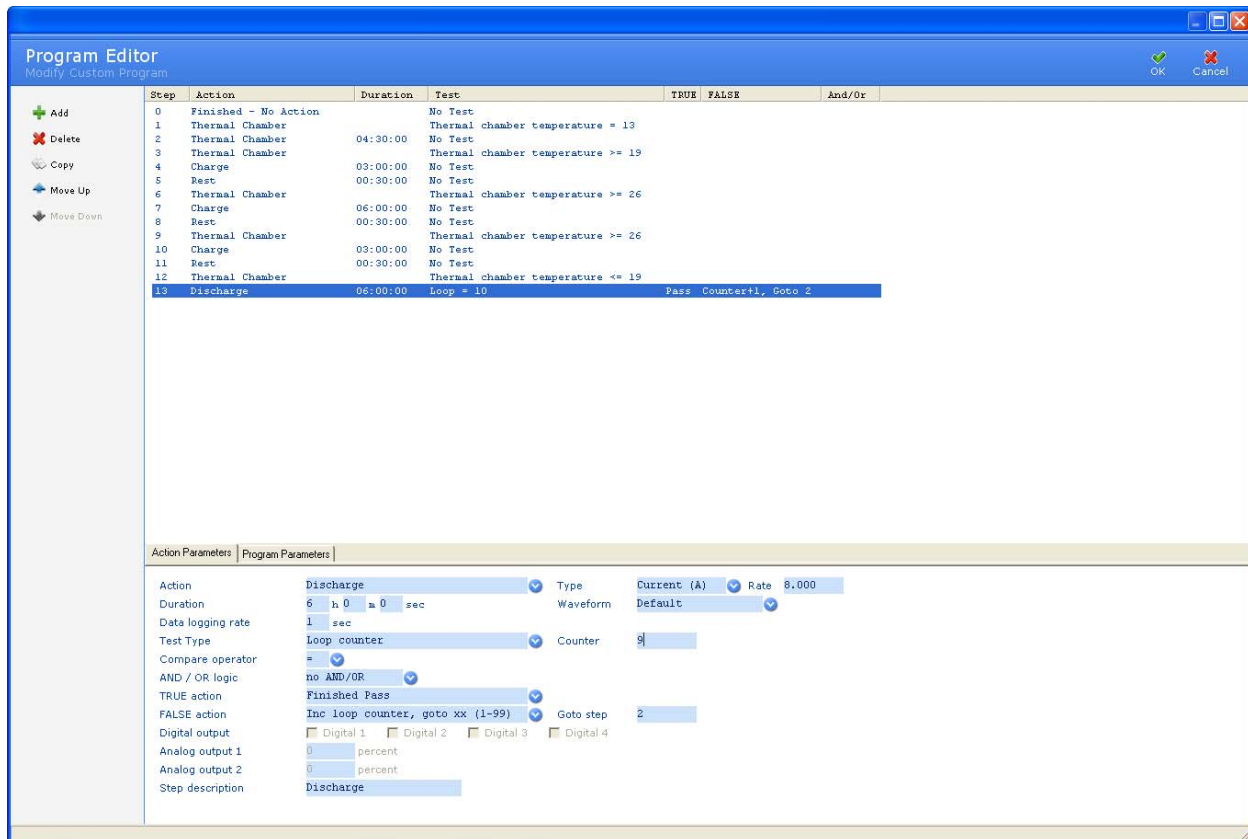




**Step 11 – Battery is Rested for 30 minutes.**



**Step 12 – Environmental temperature is decreased over a 6-hour period.**

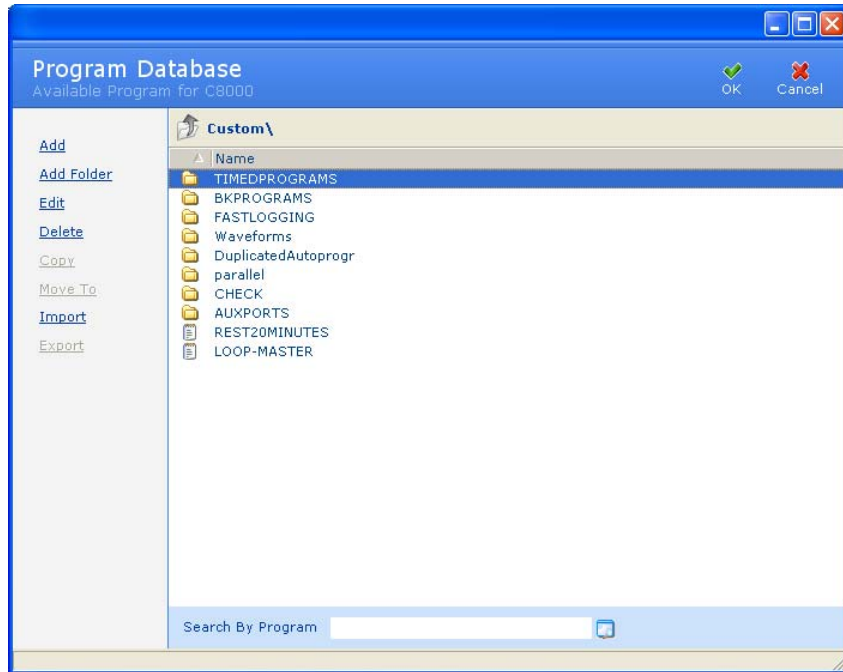


### Step 13 – Battery is discharge for 6 hours, during the temperature fall.

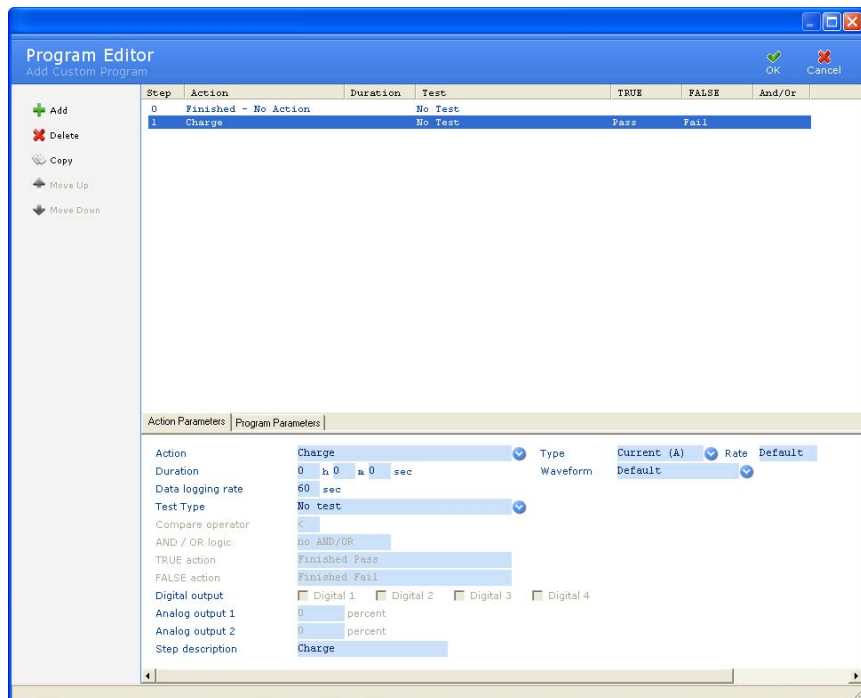
At the end of Step 13 there is a Loop Counter test. If the loop counter is equivalent 9, the test finishes otherwise, the test increments the loop counter and jumps to Step 2. Step 1 is required, only, to setup the initial test environment.

### 3.10.4 Add a Program

To add a custom program to BatteryLab, click **Programs** in the **Database** menu. The **Program Database** window appears.



Next, click **Add**. The **Add Custom Program** window appears.



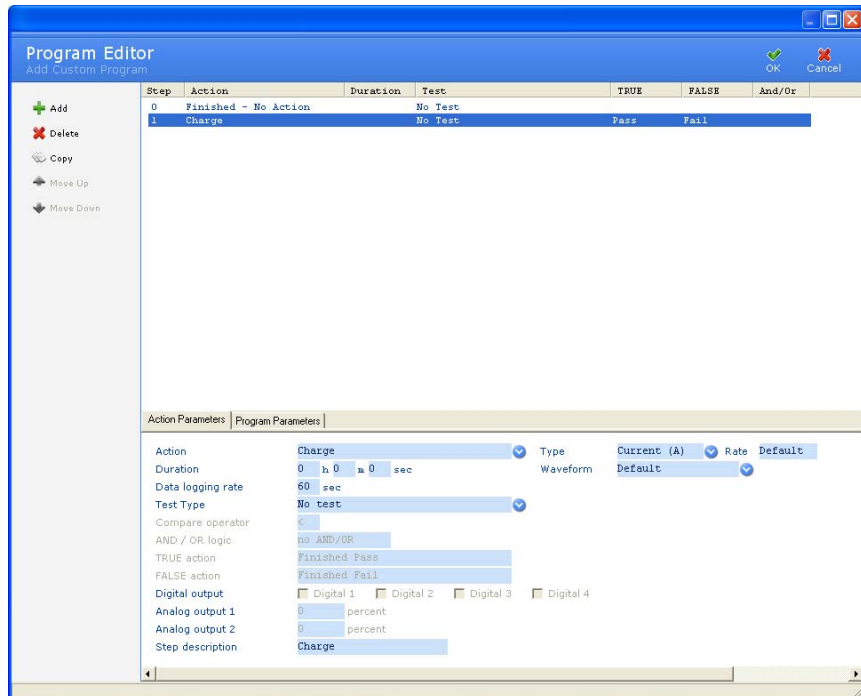
The top portion of the **Add Custom Program** window shows the individual steps in the program. For each step, BatteryLab displays the step number, the action that will be performed, the amount of time the action will take to execute, the type of test to be performed and action to take if the test is True or False. **Note:** If there is “No Test” the program will automatically go to the next step, on a successful completion of the action/step.

Step	Action	Duration	Test	TRUE	FALSE	And/Or
0	Finished - Standby		No Test			
1	Charge	00:01:00	Cap < target	Pass	Fail	
2	Discharge		No Test			
3	No Action		No Test	Pass	Fail	

When this program executes, the steps are performed in the order listed. To change the order of the steps, select the step and click **Move Up** or **Move Down**. The steps will be rearranged accordingly.

### 3.10.4.1 Add a Step to a Program

To add a step to a program, click **Add**. The *No Action* step appears in the **Program Editor** window.



Click the *Action* field to see the list of possible actions for this step. Some actions require additional information, as shown in the following table.

## Action Parameter Tables

### Available Actions

<u>Action</u>	<u>Required Action Sub-parameters</u>	<u>Description of the Action</u>
Finished - No action	None	On completion of service, stop all monitoring. Available for Step zero (0) only
Finished – Standby	None	<p>On completion of service, monitor the battery. Take action when monitor conditions are met. NIXX – perform trickle charge as per C-code.</p> <p>SLA – perform float charge will occur when the battery voltage drops below the Standby voltage parameter in the C-code. The current applied shall equal the current termination point (CTP) in the C-code.</p> <p>All Chemistries – Recharges the battery if the voltage level drops below the standby voltage of the c-code.</p> <p style="text-align: center;">Available for Step zero (0) only</p>
Discharge	<p style="text-align: center;"><b>Type:</b></p> <p>Allows the selection of the type of discharge to perform.</p> <p style="text-align: center;"><i>Current:</i></p> <p>Discharges at a specified current. Specify the current.</p> <p style="text-align: center;"><i>C-Rate:</i></p> <p>Discharges at the rate indicated.</p> <p style="text-align: center;"><i>Watt:</i></p> <p>Discharges at a constant power.</p> <p style="text-align: center;"><b>Waveform:</b></p> <p>Performs a discharge as specified by the waveform parameters.</p> <p style="text-align: center;"><i>Custom –Scaled:</i></p> <p>Scales the waveforms greatest amplitude pulse to the Discharge Rate in the C-code and if required further scales the waveform to be within the C8000 power requirements.</p> <p style="text-align: center;"><i>Custom –Absolute:</i></p> <p>Runs the Waveform as</p>	<p>Performs a Discharge on the battery.</p> <p><b>Default:</b> shall use the discharge current value in the C-code to set the rate of discharge.</p>

<u>Action</u>	<u>Required Action Sub-parameters</u>	<u>Description of the Action</u>
	programmed (No Scaling)	
Charge	<p><b>Type:</b> Allows the selection of the type of discharge to perform.</p> <p><b>Current:</b> Discharges at a specified current. Specify the current.</p> <p><b>C-Rate:</b> Discharges at the rate indicated.</p> <p><b>Waveform:</b> Performs a discharge as specified by the waveform parameters.</p> <p><b>Custom –Scaled:</b> Scales the waveforms greatest amplitude pulse to the Charge Rate in the C-C-code and if required further scales the waveform to be within the C8000 power requirements.</p> <p><b>Custom –Absolute:</b> Runs the Waveform as programmed (No Scaling)</p>	<p>Performs a Charge on the battery.</p> <p><b>Default:</b> shall use the charge current value in the C-code to set the rate of charge.</p>
Recondition	None	<p>Performs a discharge at the trickle discharge rate, as per C-code, until the end of recondition voltage is reached. (As per C-code)</p> <p>For NiXX batteries only. This step will be skipped if any other Chemistry is used.</p>
Trickle charge		<p>Performs a charge at the rate specified in the C-code, until a termination condition is reached.</p> <p>Charge rate is specified in the C-code for NiXX batteries (Trickle Charge) and for all others charge termination point (CTP) current is used.</p>
Rest	<p><b>Duration:</b> The length of time, the action is to be performed for.</p>	<p>Does not apply current to a battery, but continues to monitor all conditions.</p> <p><b>Requirement:</b> A Duration value is required.</p>
Impedance	<p><b>AC Impedance:</b> Performs a resistance</p>	<p>Calculates the resistance of a battery.</p> <p>Note: AC Impedance will only run if the program is</p>

<u>Action</u>	<u>Required Action Sub-parameters</u>	<u>Description of the Action</u>
	calculation using a 1Khz AC signwave.  <b>DC Impedance:</b> Performs a resistance calculation using DC current as per IEC standards.	conducted on channel 1.
AuxOut only	I/O ports must be enabled	Similar to REST but allows the reconfiguring of the conditions of the Auxiliary ports.
Boost	None	Will perform a charge to the battery for Duration of 3 minutes, in an attempt to raise the battery voltage.  <b>This function will disable many of the safe guards. Use with EXTERME CAUTION.</b>
Pause	None	All functions are suspended until the user prompts to continue the service by selecting “RESUME”
Discharge Playback	<b>Dchg Device</b> Selection of the Device to perform a discharge	Uses a playback waveform to perform a discharge on the C8000 or on a supported external load. Requires a supported Electronic DC Load <a href="#">See section 2.13.1.1 Programmable DC Electronic Loads</a>
Thermal Chamber	<b>Start:</b> Indicates the starting temperature for the profile.  <b>End:</b> Indicates the target temperature to be reached.  <b>Interval:</b> Controls the temperature rise of the chamber. To calculate the temperature raise per minute. (End – Start)/interval (minutes)  <b>Deviation:</b> The error allowed to the target temperature.  <b>Type:</b> Selects the support thermal	Requirement: Requires a supported Thermal Chamber <a href="#">See section 2.13.1.2 Thermal Chambers</a> Controls the temperature environment of a supported thermal Chamber.

<u>Action</u>	<u>Required Action Sub-parameters</u>	<u>Description of the Action</u>
	chambers	
Parallel Discharge	<p><b>Type:</b> Allows the selection of the type of discharge to perform.</p> <p><b>Current:</b> Discharges at a specified current. (The setting of "Default" will automatically double the Discharge Rate specified in the C-code.)</p> <p><b>C-Rate:</b> Discharges at the rate indicated.</p> <p><b>Watt:</b> Discharges at a constant power.</p> <p><b>Waveform:</b> Performs a discharge as specified by the waveform parameters.</p> <p><b>Custom –Absolute:</b> Runs the Waveform as programmed</p>	<p>Accessory Requirement: <a href="#">See section Error! Reference source not found. Error! Reference source not found.</a></p> <p>Example of Current Rate set to Default: Standard Discharge: 10A/80W Parallel Discharge: 20A/160W</p>

Within each action step the program has the ability to run a test during the action step and take appropriate action based on the result of the test. The table below lists the **Test Type** available for each action step.

### Test Types Table

<u>Test Type</u>	<u>Sub-Parameter</u>	<u>Description of the Test Type Function</u>
No Test (Default)	None	No additional test is performed
Capacity to Target	None	Compares the latest calculated Capacity value for the service against the "Target Capacity" value in a C-code. Note: If the service "Capacity Value" is "N/A" the test will not be performed. (Test is performed at the end of the step action)
Capacity diff	Requires capacity value. (Percentage) (Default: "0%")	Compares the latest calculated Capacity value for the service against the previously calculated Capacity value within the same program. Note: 1) A minimal of two "Discharge" actions are required within the same program. 2) If the service "Capacity Value" is "N/A" the test will not be performed. (Test is performed at the end



<u>Test Type</u>	<u>Sub-Parameter</u>	<u>Description of the Test Type Function</u>
		of the step action)
Total Capacity	Requires capacity value. (Percentage) (Default: "0%")	Compares the latest calculated Capacity value for the service against the capacity value entered into the program. Note: If the service "Capacity Value" is "N/A" the test will not be performed. (Test is performed at the end of the step action)
Loop Counter	Requires Counter Value parameter (Value)(Default "0")	Compares the Loop Counter value against the parameter value entered in the program. (Test is performed at the end of the step action)
Voltage	Requires Voltage value parameter (V) (Default "0.000v)	Compares the current "Voltage" reading from the channel to the entered voltage level in the program. Comparison is conducted every 100mS from the start of the program step.
Current	Requires Current value parameter (A) (Default "0.000A)	Compares the current "Current" reading from the channel to the entered Current level in the program. Comparison is conducted every 100mS, 5 seconds after the start of the program step.
Temperature	Requires Temperature value parameter (°C) (Default "0°C)	Compares the current "Temperature" reading from the channel to the entered Temperature value in the program. Comparison is conducted every 10s from the start of the program step.
Temperature Increase	Requires Temperature value parameter (°C) (Default "0°C)	Compares the difference, between the current "Temperature" reading from the channel to the first temperature value taken at the being of the step, against the Temperature value in the program. Comparison is conducted every 10s from the start of the program step.
Impedance	Requires resistance value stated in m-ohms (m-ohms) (Default "0-ohms")	Compares the Impedance value (generated by an OhmTest/Impedance step or by an automated Ohmtest) against the value entered in the program. Comparison is conducted on the completion of the step action.
Aux Port	Requires Selection of input channel & type. Plus the Voltage value parameter (V) (Default "0.000v) for analog inputs and HIGH(1)/LOW(0) selection for digital inputs.	Analog port selection; Compares the Voltage level from the specified Analog Port against the Voltage level specified with in the program; Digital Port Selection; Compares the Digital level against the value specified with in the program. Comparison is conducted every 100mS from the start of the program step.
Aux Port Diff	Requires Selection of input channel & type. Plus the Voltage value parameter (V) (Default "0.000v) for analog inputs and HIGH(1)/LOW(0) selection for digital inputs.	Analog port selection; Compares the difference, of two specified Analog ports, against the Voltage level value specified within the program step. Digital Port Selection; is ON (1) or OFF(0)
Variable Test	Requires; Selection of possible five numerical counters (A~E) and a numerical value. (Default: "0")	Compares the selected Variable (Numerical Counter) against the enter numerical value in the step. Comparison is done of the step action
Variable Diff	Requires; Selection of two of the possible five numerical counters (A~E) and a numerical value.	Compares the difference, between two selected variable counters, against the numeric value enter in the step. Comparison is done of the step action

<u>Test Type</u>	<u>Sub-Parameter</u>	<u>Description of the Test Type Function</u>
	(Default: "0")	
SM-Bus Voltage	Requires Voltage value parameter (V) (Default "0.000v")	Compares the Voltage level of a SM-bus register (0x15) against the Voltage level enter in the step. Comparison is conducted every 200mS, 5 seconds after the start of the program step.
SM-Bus Current	Requires Current value parameter (A) (Default "0.000A")	Compares the Current reading of a SM-bus register (0x14) against the current level enter in the step. Comparison is conducted every 200mS, 5 seconds after the start of the program step.

Once a **Test Type** is selected the action will need to be programmed with the comparator function to determine a "PASS" or "FAIL". The available comparators available are:

### Comparator Table

<u>Comparator</u>	<u>Description of the Comparator Function</u>
<	Less than
<=	Less then or equal to
=	Equal to
>=	Greater than or equal to
>	Greater than
<>	Not Equal to

The selected **Test Type** with the selected **comparator** can be viewed in equation format in the main window under the "Test" column.

The following actions are available for selection based on a "TRUE" or "FALSE" action.

### TRUE/FALSE action table

<u>True/False Action</u>	<u>Required Parameter</u>	<u>Description of the Program Parameter</u>
Goto Next Step	None	Automatically proceed to the next step. If the current step is the last step in the program, this action will return to step zero (0).
Goto Step xx (1-99)	Step number	Automatically proceeds to the programmed step, in the parameter. This action can not goto step zero (0)
Resets loop counter, goto next step	None	Resets the counter to zero (0) and will proceed to the next step. If the current step is the last step in the program, this action will return to step zero (0).
Inc loop counter, goto xx (1-99)	Step Number	Automatically increments the internal counter by one (1) and proceeds to the programmed step, in the parameter.

<u>True/False Action</u>	<u>Required Parameter</u>	<u>Description of the Program Parameter</u>
		This action can not goto step zero (0)
Finished Pass	None (Default for True Action)	Successfully completes the test with no warning.
Finished Fail	None (Default for False action)	Successfully Fails the test with any warning codes that where generated. (Software Failure)
Fatal	None	Hard Failure. System will immediately stop all services and "FAIL" the service
No Action	None	System will continue to run the service as is and will not trigger any additional steps of functions until the step has completed normally
Inc A, goto next step	None	Increments the secondary counter "A" by one and if the current step is the last step in the program, this action will return to step zero (0).
Inc B, goto next step	None	Increments the secondary counter "B" by one and If the current step is the last step in the program, this action will return to step zero (0).
Inc C, goto next step	None	Increments the secondary counter "C" by one and If the current step is the last step in the program, this action will return to step zero (0).
Inc D, goto next step	None	Increments the secondary counter "D" by one and If the current step is the last step in the program, this action will return to step zero (0).
Inc E, goto next step	None	Increments the secondary counter "E" by one and If the current step is the last step in the program, this action will return to step zero (0).
Reset A, goto next step	None	Resets the secondary counter "A" to zero (0) and proceeds to the next step. This action can not goto step zero (0)
Reset B, goto next step	None	Resets the secondary counter "B" to zero (0) and proceeds to the next step. This action can not goto step zero (0)
Reset C, goto next step	None	Resets the secondary counter "C" to zero (0) and proceeds to the next step. This action can not goto step zero (0)
Reset D, goto next step	None	Resets the secondary counter "D" to zero (0) and proceeds to the next step. This action can not goto step zero (0)
Reset E, goto next step	None	Resets the secondary counter "E" to zero (0) and proceeds to the next step. This action can not goto step zero (0)

Each action step with in the program is capable of changing the state of the Analog/Digital Output Ports. For these options to be

available the Ports must be configured as Output. (See [Program Parameter Table](#))

The Digital Outputs can be set as either high, by placing a check mark in the box beside the corresponding Digital Output port and set low (Default) by clearing the check mark.

The Analog Output can be set to an output a voltage level changing the percentage value for the corresponding Analog Output Port. A value of 0% will output zero (0) volts while a value of 100% will output a voltage of five (5) volts.

Each step with in a program can be assigned a unique name, for identification purposes, by changing or adding text to the **Step Description** field.

Once all the steps of the program have been added the information for the program may be entered.

Click on the **Program Parameter** tab and enter information in to the fields. The fields' functionalities are defined as shown in the following table.

### **Program Parameter Table**

<b><u>Field</u></b>	<b><u>Default State</u></b>	<b><u>Description of the Program Parameter</u></b>
Program Name	Blank	The name of the program (This is a required field)
Active	Checked	Allows the program to be used in a service. Removing the check will remove this program from the available list when attempting to service a battery.
Smart Battery	Unchecked	Enables the program to be used with SM-BUS C-codes
Term. Data Sample Rate	Default, 500 times per second (2ms)	The C8000 will automatically save the last 500 data points for the Voltage and Current at a high capture rate. This parameter will program the rate in which the C8000 sample the last 500 points.  Options available: Default, 500 times per second (2ms) 100 times per second (10ms) 50 times per second (20ms) 25 times per second (40ms) 20 times per second (50ms) 10 times per second (100ms) 5 times per second (200ms)
Comment 1	Blank	Comment Field that can be used to store information

<u>Field</u>	<u>Default State</u>	<u>Description of the Program Parameter</u>
		about the program.
Comment 2	Blank	Comment Field that can be used to store information about the program.
Custom waveform	Blank	Attaches a custom waveform to the program. The program will run the indicated waveform, for the steps that indicate Custom waveform.
Dchg Playback waveform	Blank	Attaches a Playback waveform to the program. This waveform is only used if a Discharge Playback action step is with in a program.
Analog Input/Output	Unchecked	Enables any of the Analog input or output port of the C8000. Check mark the Analog ports to enable  The Analog output ports have a 0~5 volt range and the output value is controlled in the Action Parameter Tab.
Analog Input Range	0~5v	Configures the input voltage range for the associated Analog Port.  Options available: 0~5 volts 0~10 volts 0~15 volts
Digital Input/Output	Off	Configures the associated Digital Port as digital input or a digital output.  Options available: Off Input Output

#### 3.10.4.2 Remove a Step from a Program

To delete a step, select the step and click **Delete**. The step is removed from the list.

#### 3.10.4.3 Copy a Step in a Program

To create a duplicate step, select the step to copy and click **Copy**. The new step appears in the list.

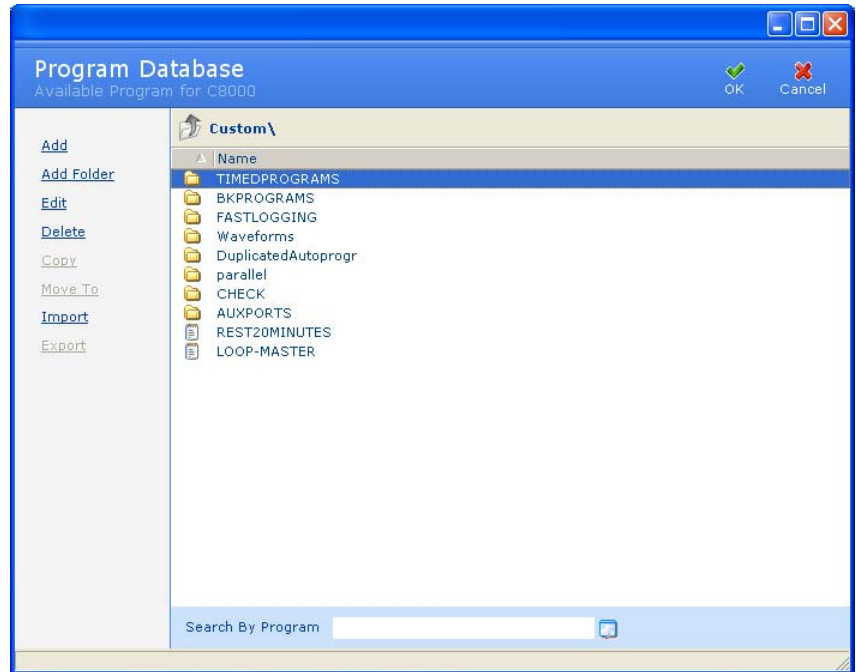
#### 3.10.4.4 Save the Custom Program

Click **OK** to save the program.

### 3.10.5 Add Folders

Programs can be organized, or grouped, into folders. A folder is a directory on your hard drive. A folder icon appears adjacent to the folder's name to identify it as a folder; a text document icon adjacent to the program's name can identify programs. Only one level of folders is permitted.

1. From the **Database** menu, click **Programs**. The **Program Database** window appears.



2. Click **Add Folder**. The **Add Folder** window appears.



3. In the *Folder Name* field, type a name for this folder.
4. Click **OK** to create the folder. The folder's name appears in the **Program Database** window.

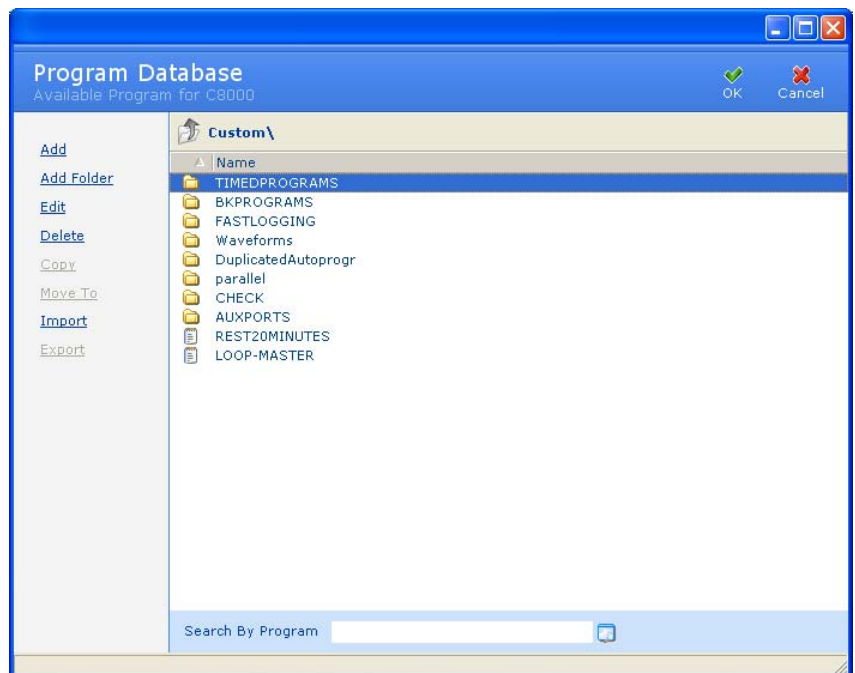
5. To view the contents of a folder, double-click the folder's name. The programs stored in that folder appear in the **Program Database** window.

---

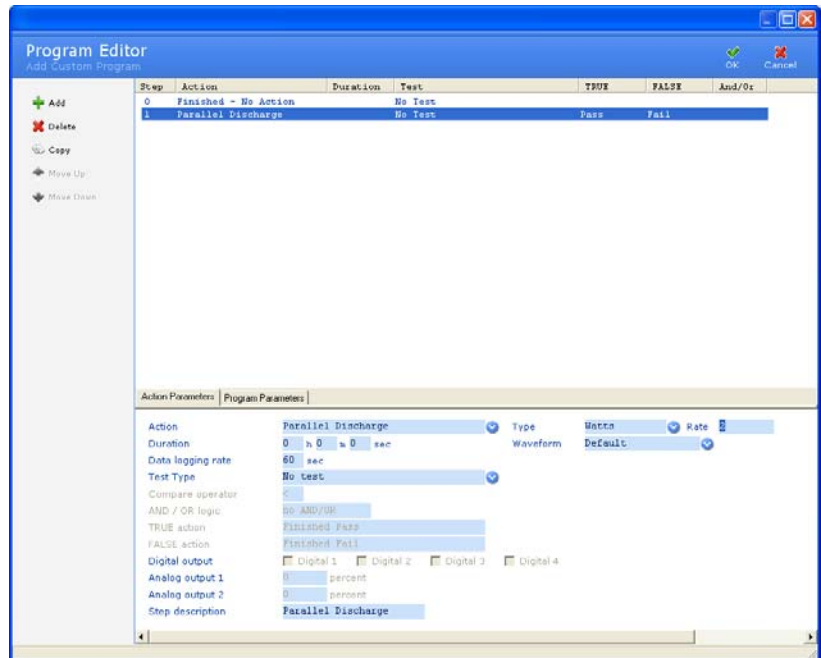
### 3.10.6 Edit a Program

BatteryLab allows edits to custom programs created by the user. System and SM-Bus programs cannot be edited or copied to create a program.

1. From the **Database** menu, click **Programs**. The **Program Database** window appears.



2. Select the program to edit.
3. Click **Edit**. If database security is enabled, the **Password** window appears.
4. Enter your password and click **OK**. The **Program Editor** window appears.



5. Select the step to change. Make the required changes to the record.
6. Click **OK**.

### 3.10.7 Delete a Program

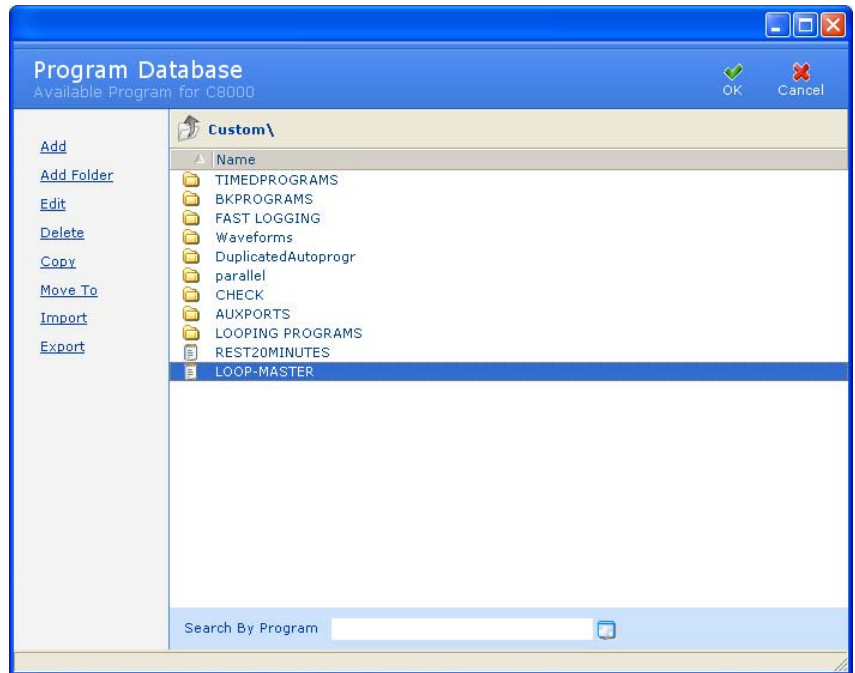
BatteryLab allows deletion of a custom program provided there are no running tests using this program. Historical data related to this program is retained for display and reporting operations.

Note: it is not possible to delete factory programs.

To delete a program from BatteryLab:

1. From the **Database** menu, click **Programs**. The **Program Database** window appears.

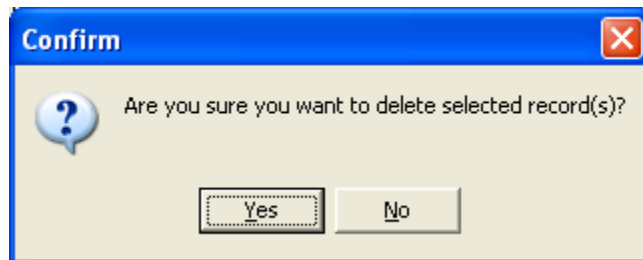




2. Select the program to delete. Click **Delete**. If database security is enabled, the **Password** window appears.



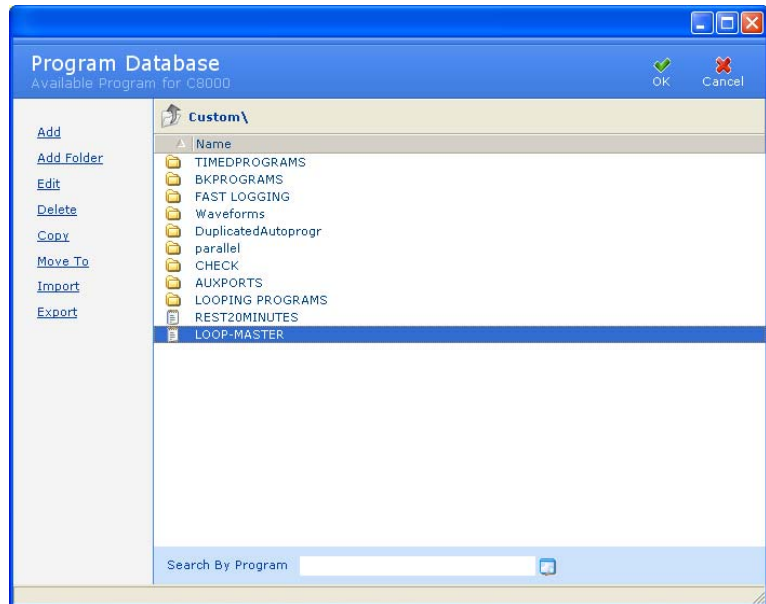
3. Enter your password and click **OK**. The **Delete Options** window appears. Select the *Delete From BatteryLab* check box. Click **OK**. The **Confirm** window appears.



4. Click **Yes**.

To delete a program from the connected C8000:

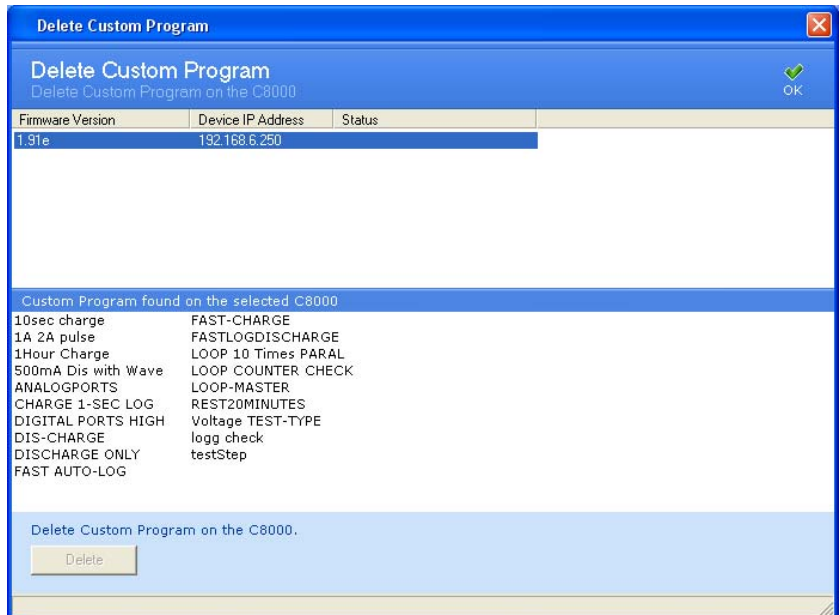
1. From the **Database** menu, click **Programs**. The **Program Database** window appears.



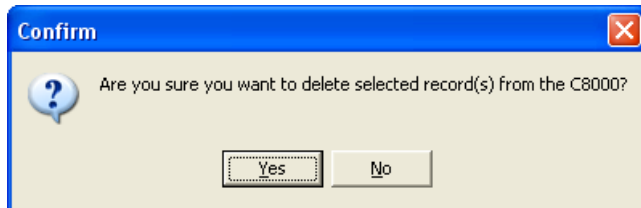
2. Select the program to delete. Click **Delete**. If database security is enabled, the **Password** window appears.



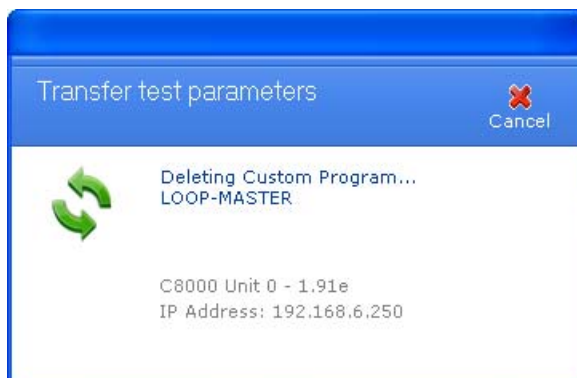
3. Enter your password and click **OK**. The **Delete Options** window appears. Select the *Delete From Connected C8000* check box. Click **OK**. The **Delete Custom Program** window appears.



4. Select the custom program to delete and click **Delete**.
5. The **Confirm** window appears.



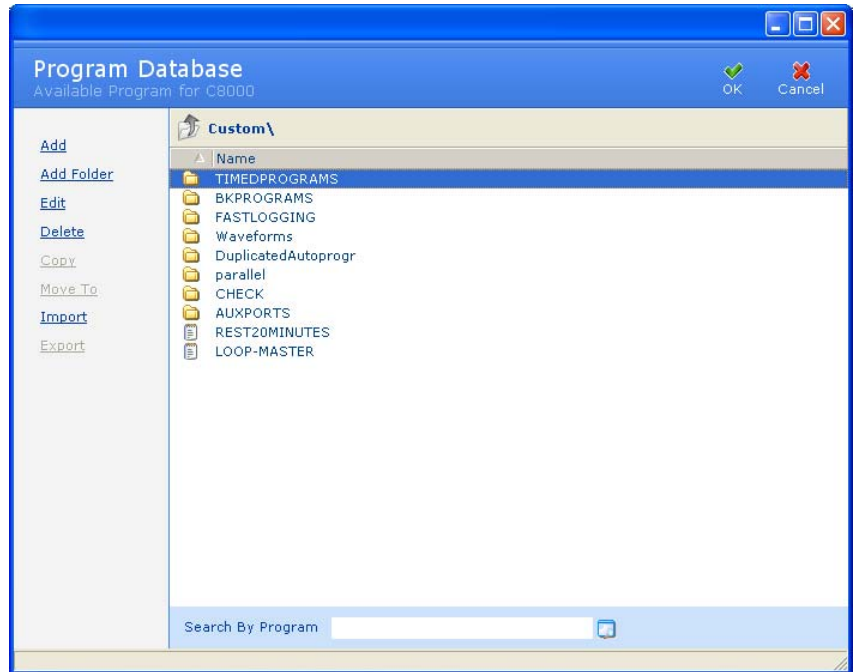
6. Click **Yes**.



### 3.10.8 Copy a Program

It is possible to create a program based on a custom program.

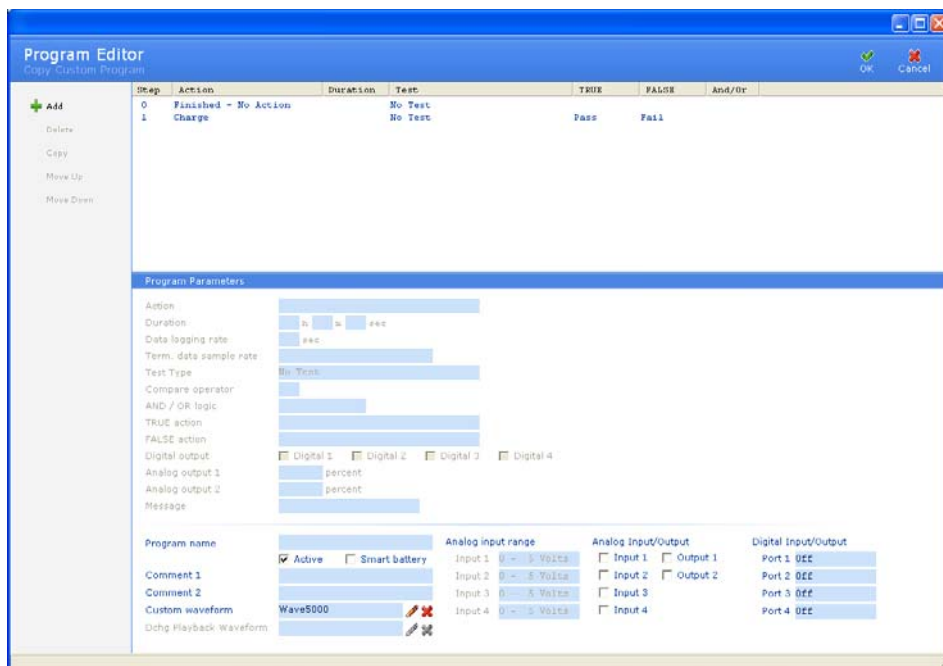
1. From the **Database** menu, click **Programs**. The **Program Database** window appears.



2. Select the program to copy.
3. Click **Copy**. If database security is enabled, the **Password** window appears.



4. Enter your password and click **OK**. The **Program Editor** window appears.

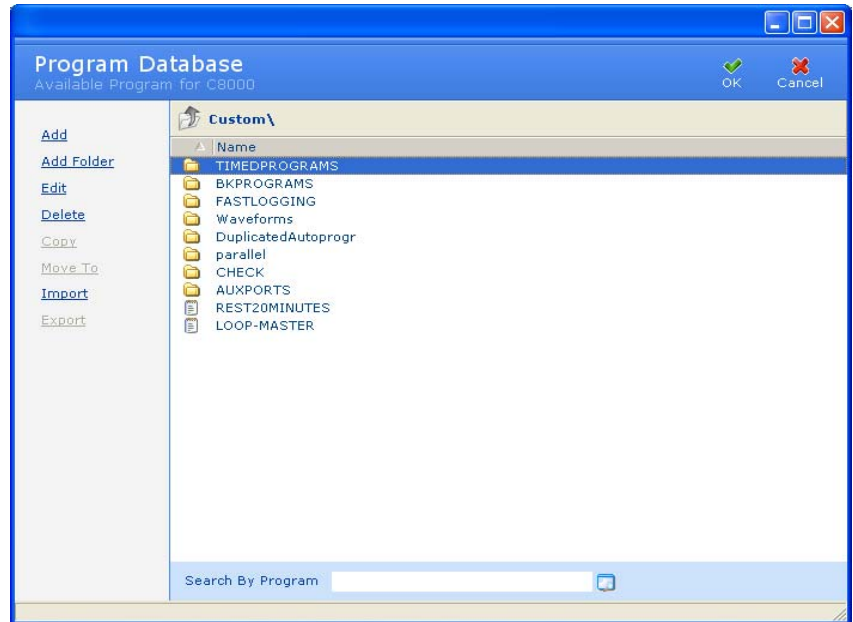


5. Type a name for the new program in the *Program Name* field.
6. Select the *Active* check box if the program is to be an active program.
7. Type any notes in the *Comment 1* and *Comment 2* fields, as required.
8. Select a waveform for the program. Click **Browse**. The **Waveforms** window appears. Select the waveform for this program and click **OK**. Note: specifying a custom waveform is optional.
9. Click **OK**. The new program appears in the **Program Database** window.

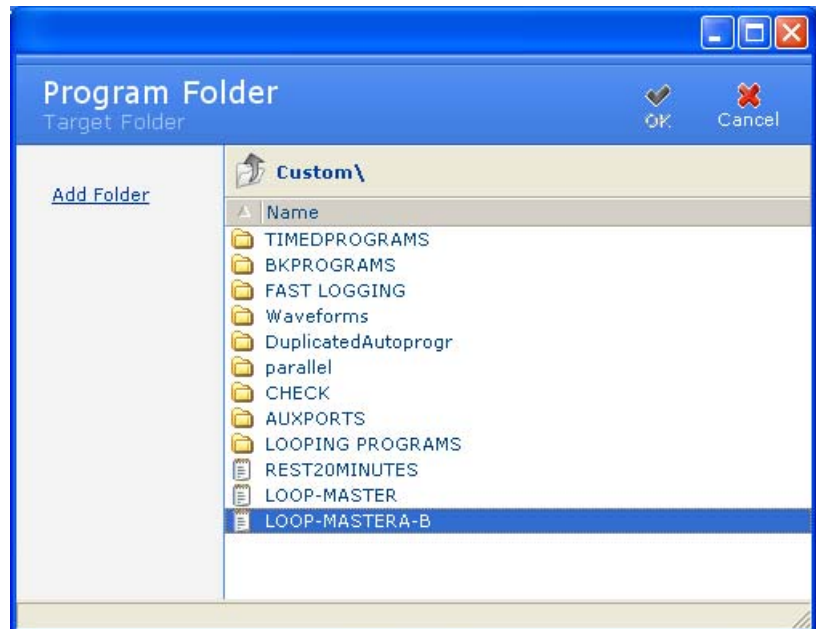
### 3.10.9 Organize Programs in Folders

Programs can be organized, or grouped, into folders. To move a program to a folder:

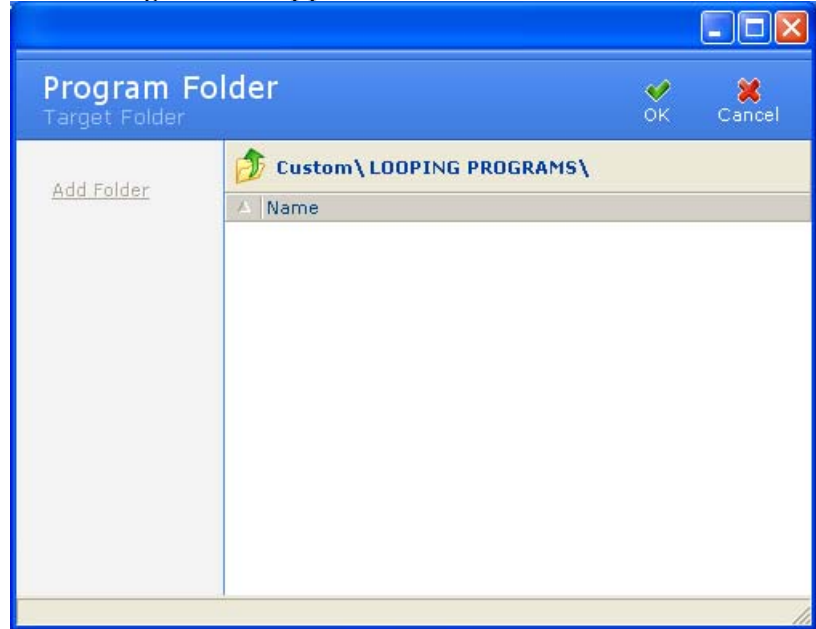
1. From the **Database** menu, click **Programs**. The **Program Database** window appears.



2. Select the program (identified by a text document icon) to move to a folder.
3. Click **Move To**. The **Target Folder** window appears.



4. Double-click the name of the folder to move the program to. The target folder appears.

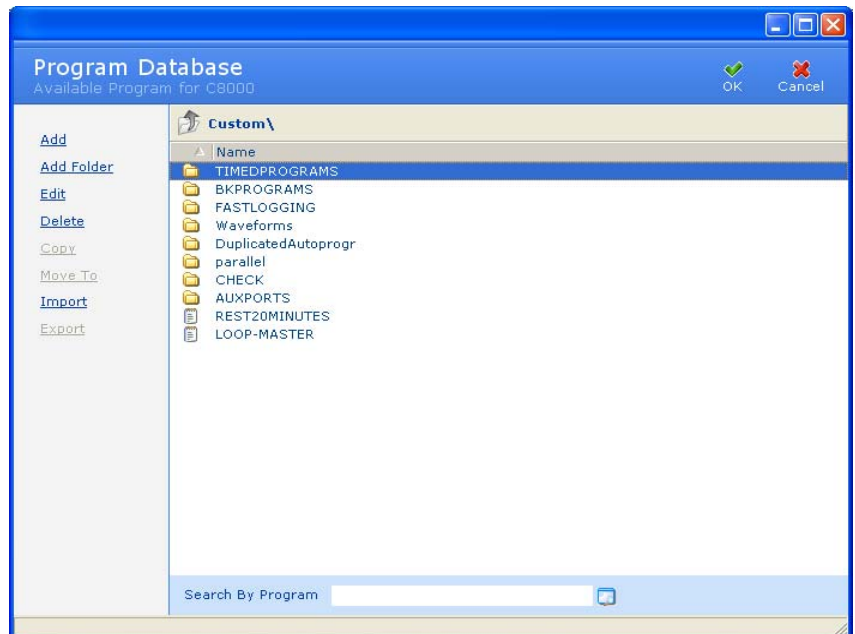


5. Click **OK**. The program is moved to the target folder.

### 3.10.10 Import a Program

To import a program from a file:

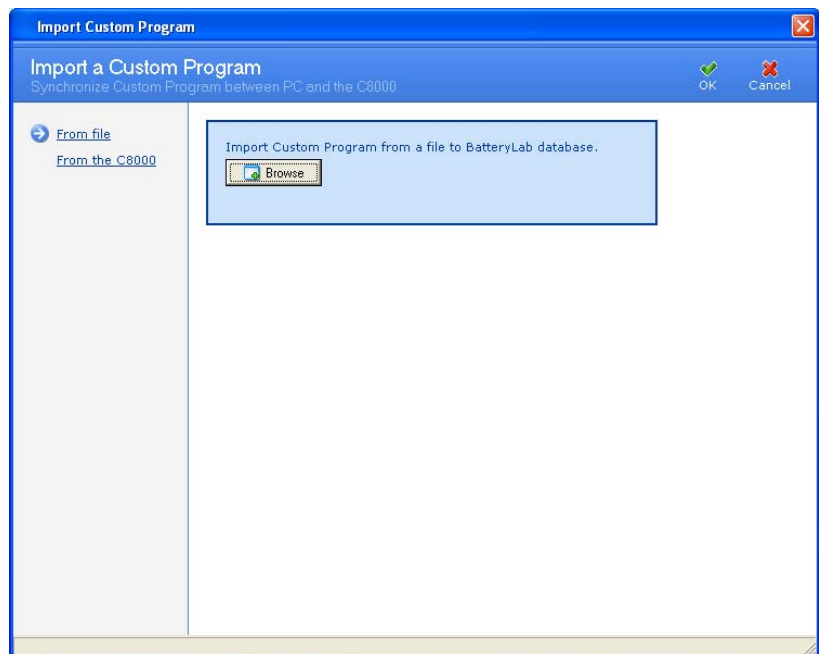
1. From the **Database** menu, click **Programs**. The **Program Database** window appears.



- Click **Import**. If database security is enabled, the **Password** window appears.

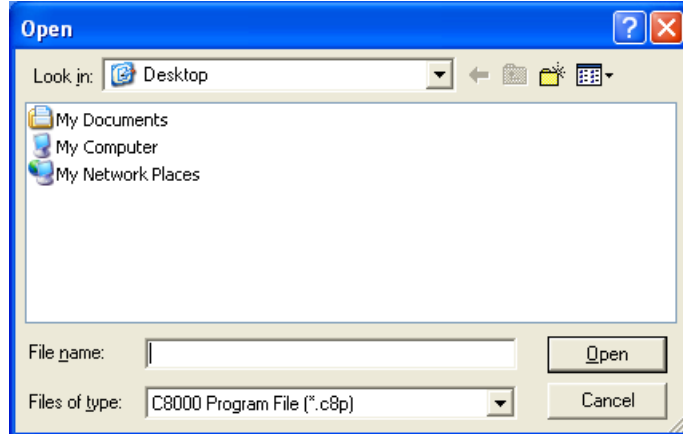


- Enter your password and click **OK**. The **Import Program** window appears.





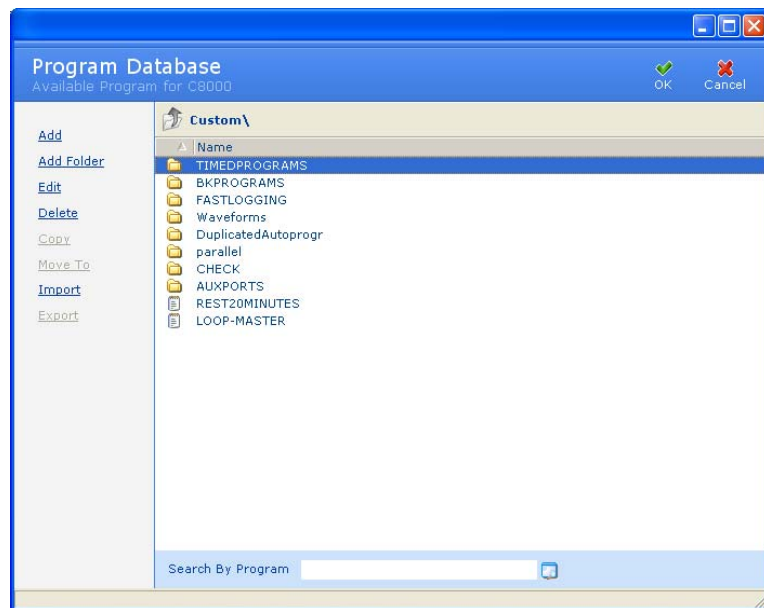
4. Click **Browse**. The **Open** window appears.



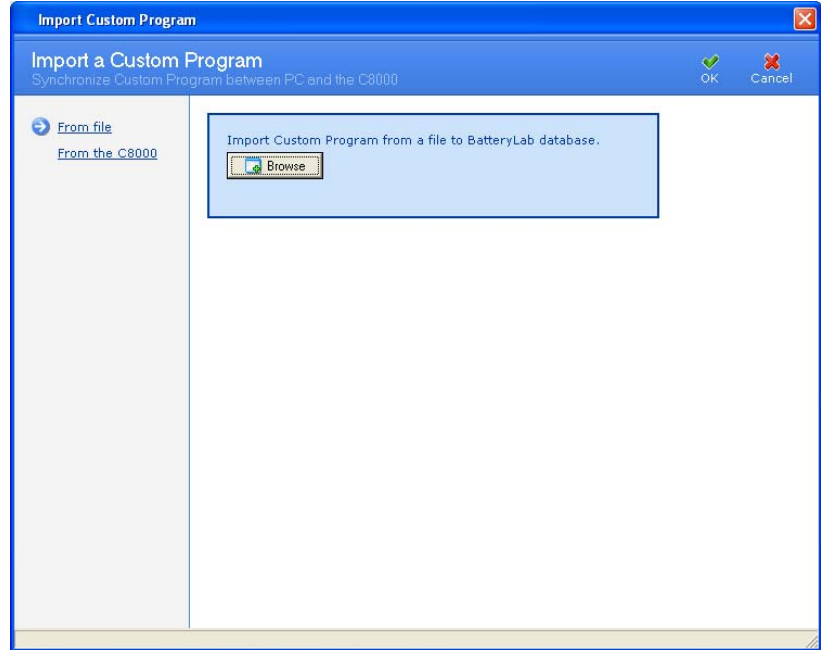
5. Select the file to import.
6. Click **Open**. Note that a single file can contain multiple programs. The **Information** window appears with the number of programs imported. (If the program already exists, click **Cancel** to terminate the import process altogether, or **OK** to overwrite the existing program. Alternatively, specify a different name for the program and click **OK** to import it.)

To import a program from the C8000:

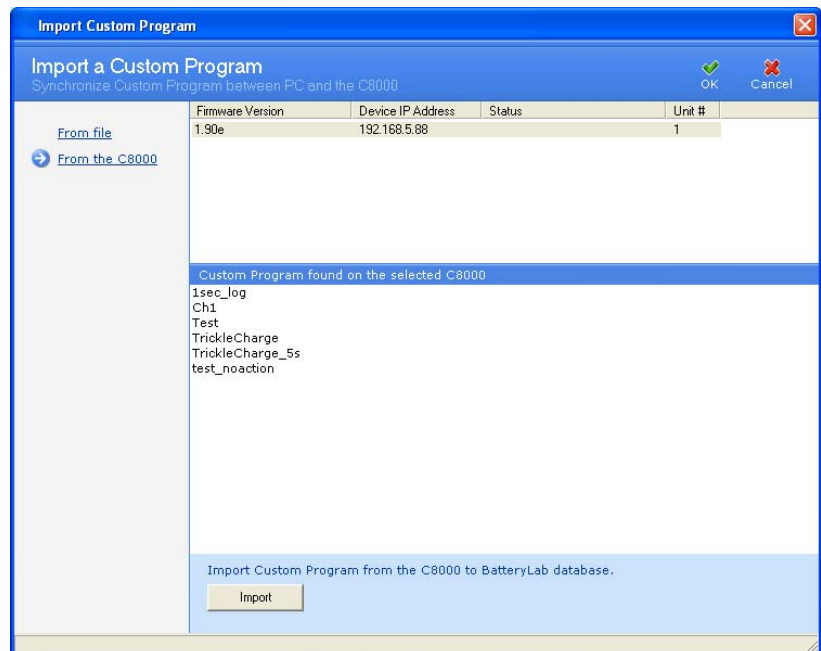
1. From the **Database** menu, click **Programs**. The **Program Database** window appears.



- Click **Import**. The **Import Program** window appears.



- Click **From the C8000**. Select a C8000 first from the list (C800s are listed by their IP addresses). Select the program to import and click **Import**. The **Import Program** window shows the programs.

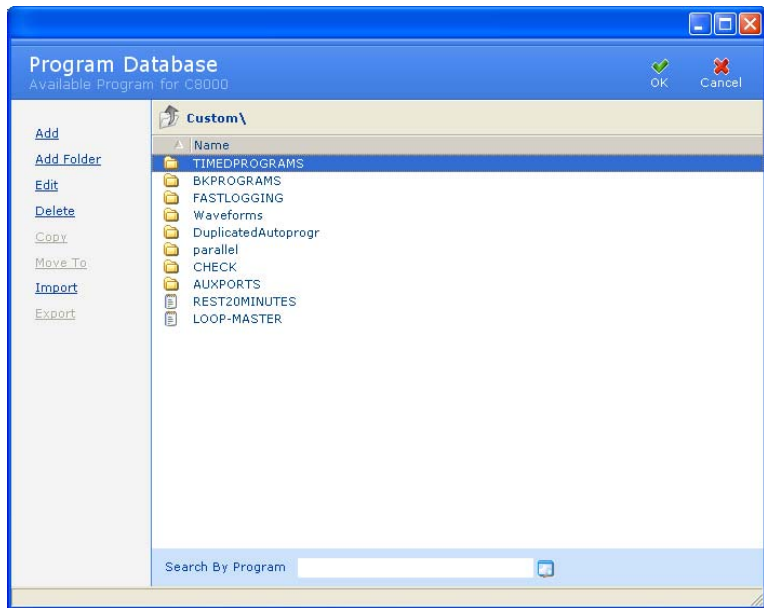


- Select the program to import.
- Click **Import**. The **Information** window appears with the number of files imported.

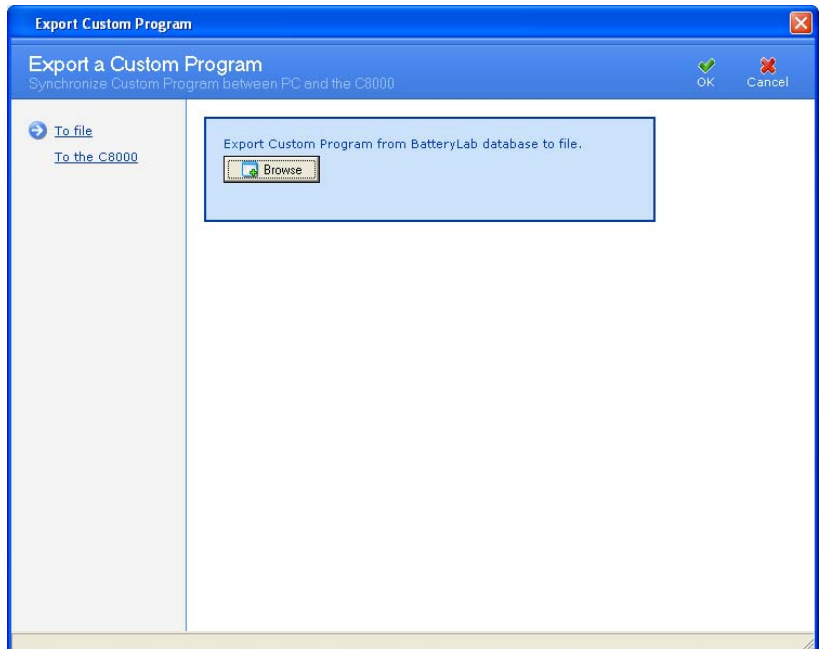
### 3.10.11 Export a Program

To export a program to a file:

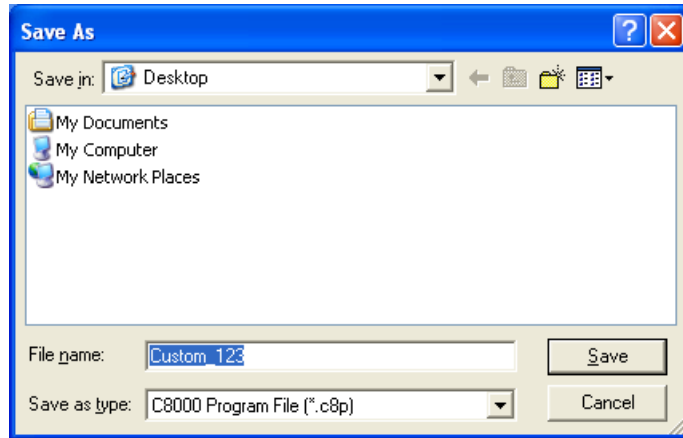
1. From the **Database** menu, click **Programs**. The **Program Database** window appears.



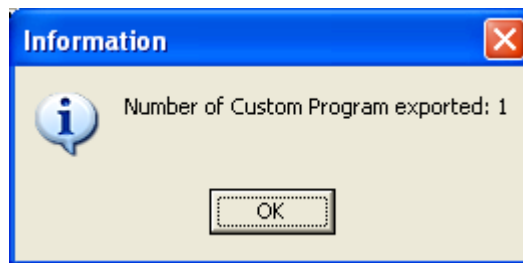
2. Select the program to export.
3. Click **Export**. The **Export a Program** window appears.



Click **Browse**. The **Save As** window appears.



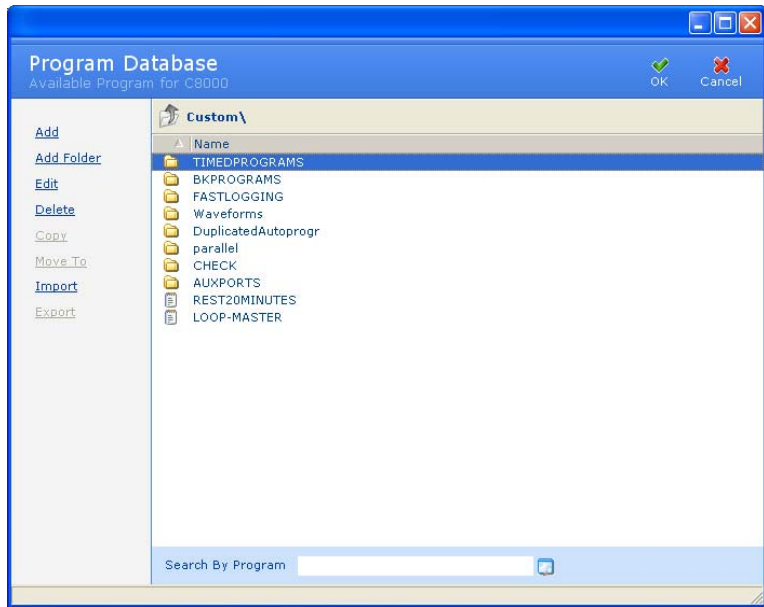
4. Type a name for the export file in the *File Name* field.
5. Click **Save**. Note that multiple programs can be exported to a single file. The **Information** window appears with the number of programs exported to the file.



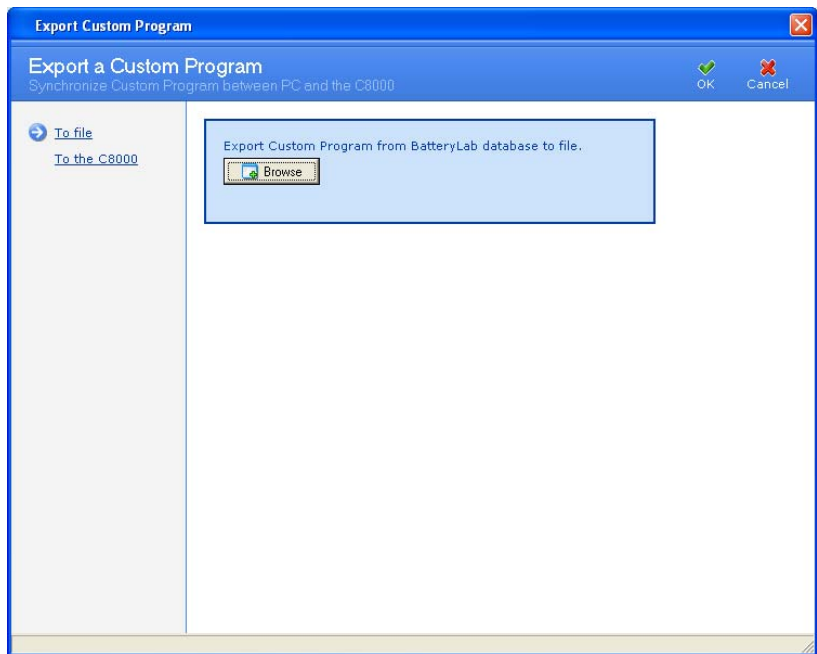
6. Click **OK**.

#### To export a program to the C8000:

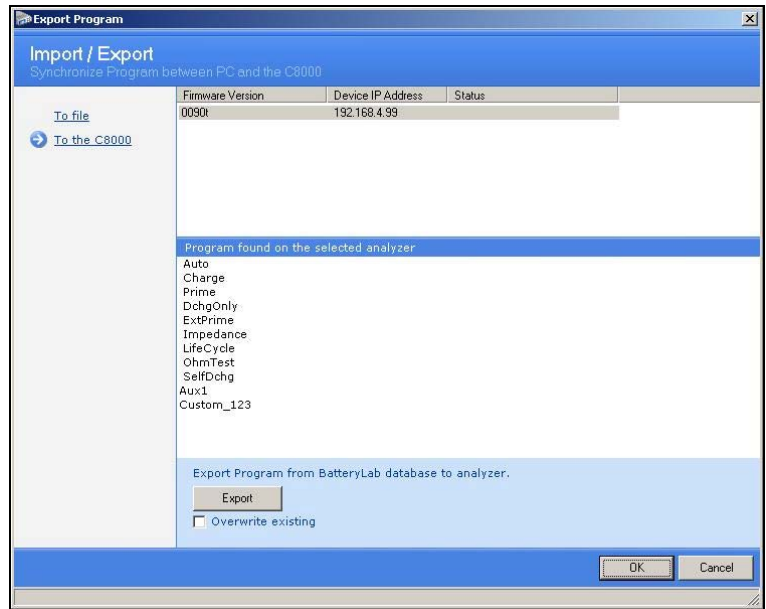
1. From the **Database** menu, click **Programs**. The **Program Database** window appears.



2. Select the program to export.
3. Click **Export**. The **Export a Program** window appears.



4. Click **To the C8000**. The **Export Program** window updates with a list of connected C8000s.



5. Click the C8000 to export programs for. The window lists the programs found on this C8000.
6. Click **Export**. Note that multiple programs can be exported to a single file. The **Information** window appears with the number of program files exported.

### 3.10.12 Search for a Program

The BatteryLab database may contain many programs. To find a specific program, click the *Search By Program* field to move the cursor to that field.



Next, type the first one or two characters of the program to find. As BatteryLab locates the partial program, it will highlight the corresponding program's name in the **Program Database** window.

### 3.10.13 Sort Programs and Folders

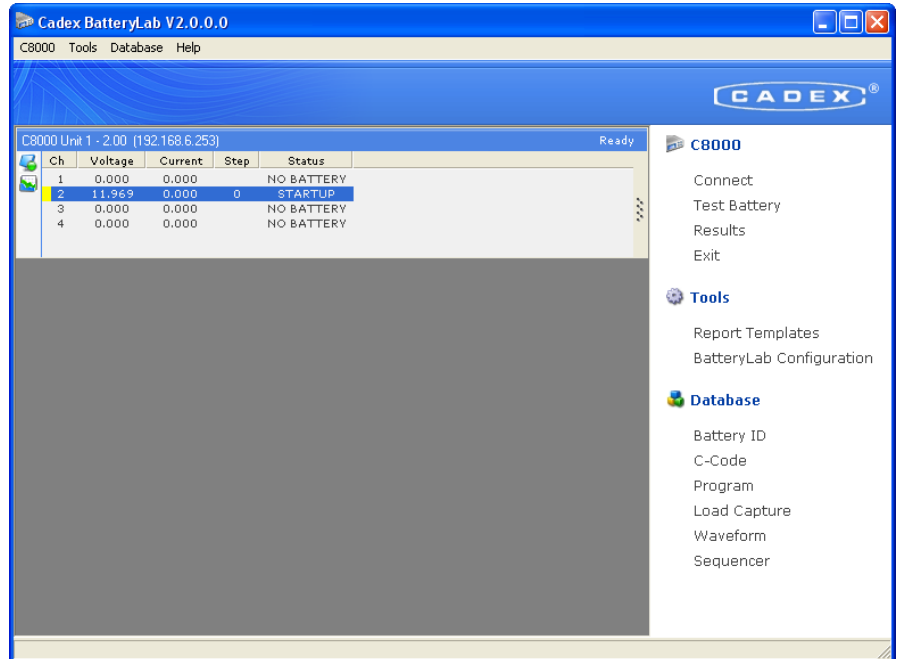
The BatteryLab database may contain many programs and folders. To sort the programs and folders in ascending order click the *Name* column the **Program Database** window. Click the *Name* column a second time to sort the programs and folders in descending order.

## 3.11 Load Capture

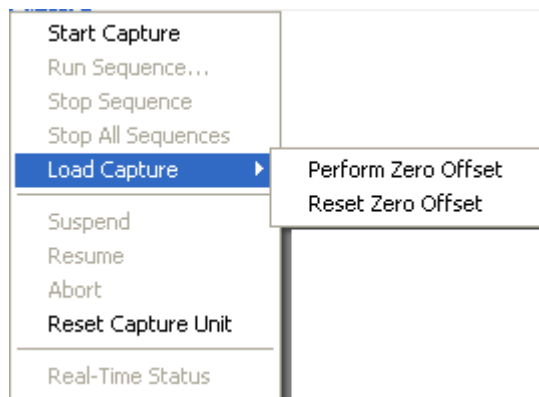
Load Capture Unit required (see [2.1.3.4 Load Capture Unit \(LCU\)](#))

To begin load capture:

1. Plug in the LCU on Channel 1 only. The *Test Battery* caption now changes to *Start Capture* when the active selected channel is connected to the LCU. The channel's status now reads *LCU STARTUP*.



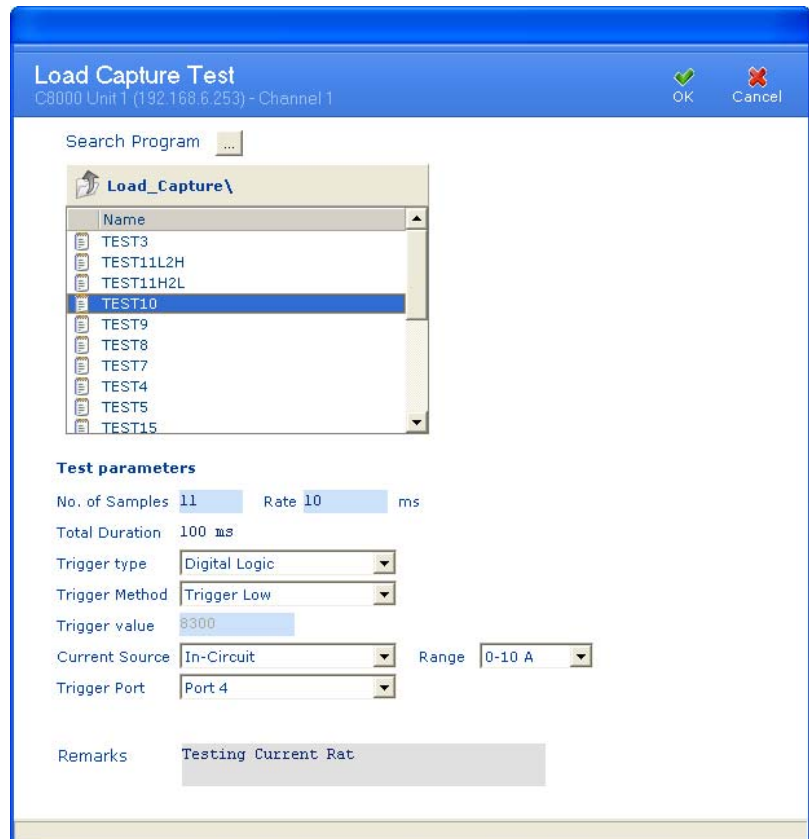
2. Click **Start Capture** to start the load capture, or right-click the LCU's entry to see the **Capture** menu and click **Start Capture**.



**Note:** The following table describes the entries in the **Capture** menu.

Menu Item	Description
Start Capture	Starts a load capture.
Load Capture	Set the in-circuit zero offset (Current Only):  <i>Perform zero offset</i> - Set the zero offset to the current level being measured.  <i>Reset Zero offset</i> - Reset the zero offset to the default value, determined when the LCU was connected to the C8000.
Reset Capture Unit	Resets the LCU to its StartUp state.  <b>Note:</b> This functional will perform a Zero offset function for both the current and voltage inputs.

3. The **Load Capture Test** window appears.





4. Click the eclipse (“...”) button next to the *Search Program* field to open the Program Editor for Load Capture programs. All pre-defined programs will appear in a window and the active program parameters will be populated in the *Test Parameters* section.

The *Test Parameters* can be modified and will be saved on selecting “OK”

5. Click **OK**. The capture begins.
6. Once the program is loaded, the Channel status reads *LCU ARMED* until the trigger condition is met. When capturing, the status reads *LCU CAPTURING* and *FINISH* will appear on completion. A window appears indicating the status and the Test ID that has been attached to the captured waveform.
  - a. If no trigger condition is present the LCU will begin capturing immediately. Note: There is an approximate 3 ~5 second delay between the program begin initialized and the C8000 begin the capture. This is normal operation while the Load Capture Unit is configured for use.
7. To view the captured waveform, click **Waveforms** in the **Database** menu. The **Waveform Database** window appears.
8. Click the **Load Capture** folder and open the corresponding waveform ID indicated in the pop-up window.



The following table describes the fields in the **Load Capture Test** window. (Page 192)

Field	Description
No. of Samples	The number of sample points to be captured (minimum=10, maximum=500).
Rate	The sample rate for each point – stated in milli-seconds with a range of 0.5ms to 30000ms.
Total Duration	The total capture period.
Trigger Type	<p>The method of triggering the capture:</p> <p><i>No trigger:</i> No trigger is defined. The capture starts immediately on completing initializing.</p> <p><i>Current limit:</i> A current target level is required to start the capture (requires <i>Trigger Method</i> definition).</p> <p><i>Digital Logic:</i> A digital level is required to start the capture (requires <i>Trigger Method</i> and <i>Trigger Port</i> definition).</p> <p><i>Analog Input Port 4:</i> An analog voltage level is required to start the capture (requires <i>Trigger Method</i> and <i>Range</i> definition).</p> <p><i>Range:</i> Defines the input voltage range of the analog port (selectable ranges: 0-5v, 0-10v, 0-15v).</p>
Trigger Method	<p>Defines the condition for the <i>Trigger Type</i> parameter:</p> <p><i>Trigger High:</i> Reading must be higher than the point as defined by the <i>Trigger Type</i> parameter.</p> <p><i>Trigger Low:</i> Reading must be lower than the point as defined by the <i>Trigger Type</i> parameter.</p> <p><i>Low-&gt; High:</i> Reading must transition from a lower to a higher reading than the target point defined by the <i>Trigger Value</i> parameter.</p> <p><i>High-&gt;Low:</i> Reading must transition from a higher to a lower reading than the target point defined by the <i>Trigger Value</i> parameter.</p> <p><b>Note:</b> Current is defined in Negative Logic.</p>
Trigger Value	The trigger point. Defined as current (mA) for <i>Current Limit</i> and voltage (mV) for <i>Analog Input Port 4</i> .
Current Source & Range	<p>The input source that a current is to be captured on.</p> <p><i>In-circuit:</i> Selects the internal capture circuit of the</p>

	<p>LCU.</p> <p>Sub-Parameters:</p> <p><i>Range 0-10A:</i> captures current range from 0-10A;  <i>Range: 0-100A:</i> captures the current range from 0-100A.</p> <p><i>Current Probe:</i> Captures current readings input from an external probe. (Scale 1mV to 1A)</p>
Trigger Port	The sub-parameter for the <i>Trigger Type</i> parameter's <i>Digital</i> option that allows the selection of the digital input for triggering.
Remarks	Notes about the capture program.

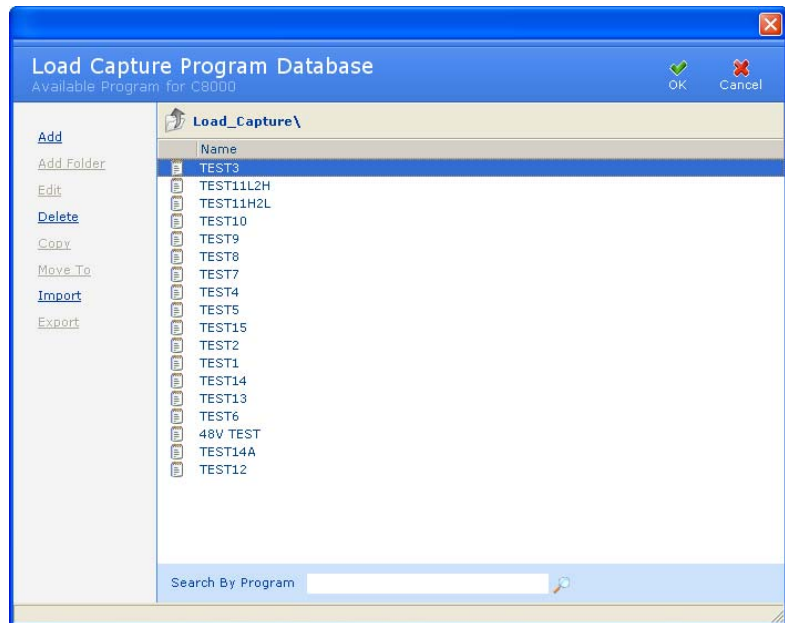
### 3.11.1 Load Capture Programs Database

The **Load Capture Program** window displays a list of load capture programs in the BatteryLab database.

### 3.11.2 Add a Load Capture Program

To add a load capture program to BatteryLab:

1. From the **Database** menu, click **Load Capture**. The **Program Database** window appears.



2. Click **Add**. The **Load Capture Program Editor** window appears.

**Load Capture Program Editor**  
Add Load Capture Program

**Test parameters**

No. of Samples: 11 Rate: 10 ms

Total Duration: 100 ms

Trigger type: Analog Input Port 4 Range: 0 to 5 V

Trigger Method: Low -> High

Trigger value: 4800 mV

Current Source: In-Circuit Range: 0-10 A

Trigger Port: Port 4

Program name:

Comment 1:

Comment 2:

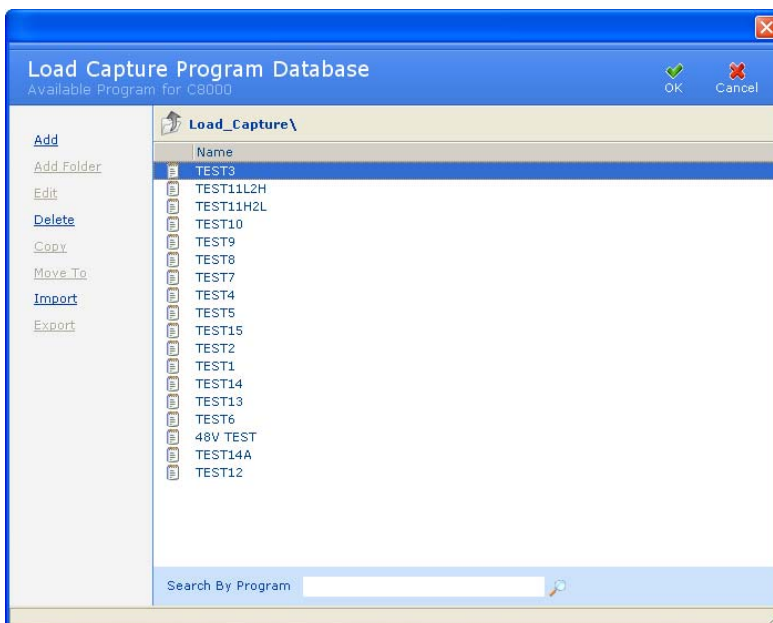
(See Page 194 for Test Parameter definitions)

3. Enter in the Test Parameters.
  - a. If required, edit the Comment “x” fields in the **Load Capture Program Editor** window to describe the load capture program.
4. Type a name for the load capture program in the *Program Name* field.
5. Click **OK**. The new load capture program appears in the **Program Database** window.

### 3.11.3 Edit a Load Capture Program

To edit a load capture program:

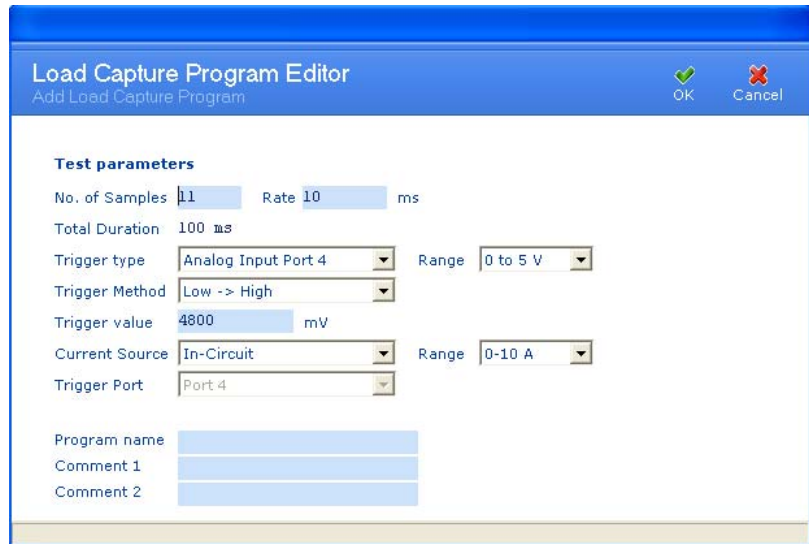
1. From the **Database** menu, click **Load Capture**. The **Program Database** window appears.



2. Select the load capture program to edit.
3. Click **Edit**. If database security is enabled, the **Password** window appears.



4. Enter your password and click **OK**. The **Load Capture Program Editor** window appears.

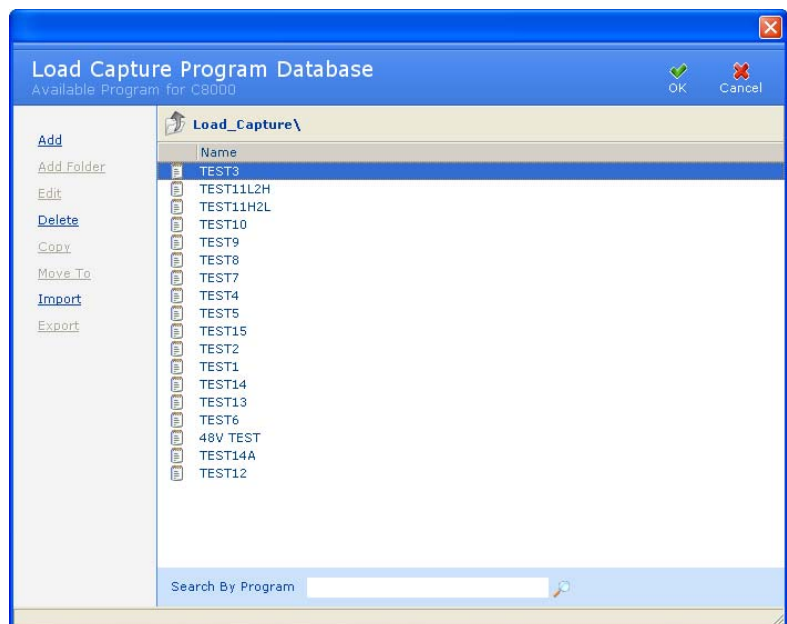


5. Edit the information as required.
6. Click OK.

### 3.11.4 Delete a Load Capture Program

To delete a load capture program from BatteryLab:

1. From the **Database** menu, click **Load Capture**. The **Program Database** window appears.

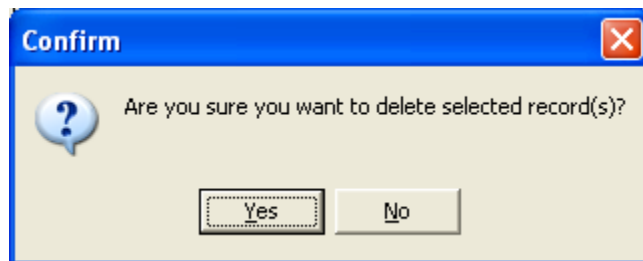


2. Select the load capture program to delete.

3. Click **Delete**. If database security is enabled, the **Password** window appears.



4. Enter your password and click **OK**. The **Confirm** window appears. Click **Yes** to delete the load capture program.

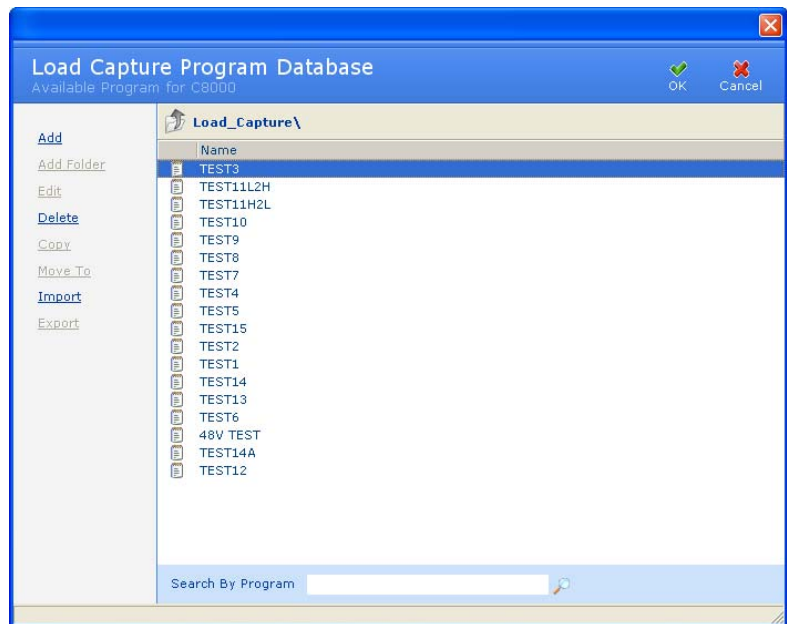


---

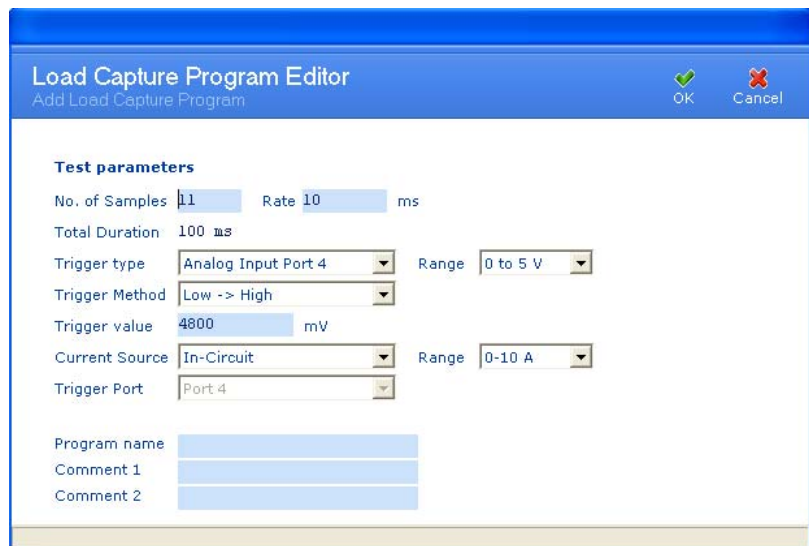
### 3.11.5 Copy a Load Capture Program

To create a load capture program based on an existing load capture program:

1. From the **Database** menu, click **Load Capture**. The **Program Database** window appears.



2. Select the load capture program to copy.
3. Click **Copy**. The **Load Capture Program Editor** window appears.



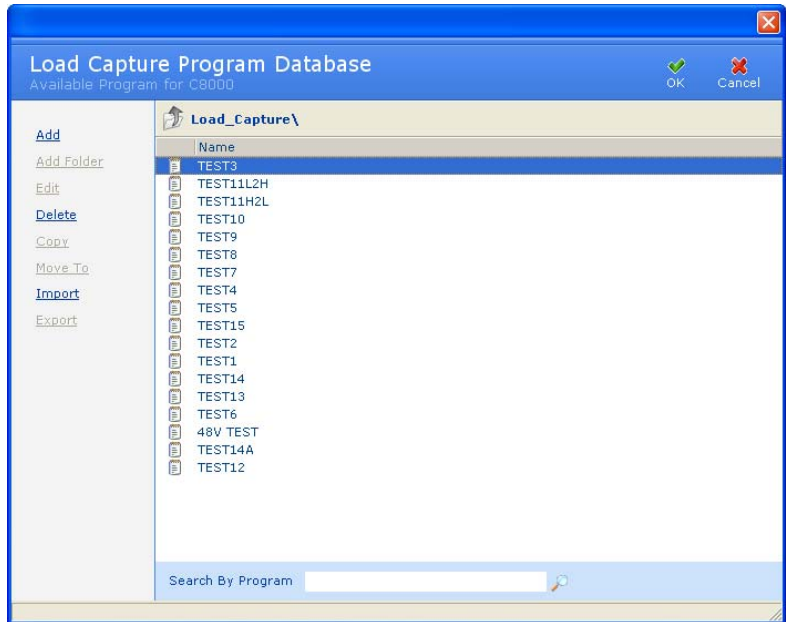
4. Edit the settings for the load capture program, as required.
5. Type a name for the new load capture program in the *Program Name* field.
6. Click **OK**.



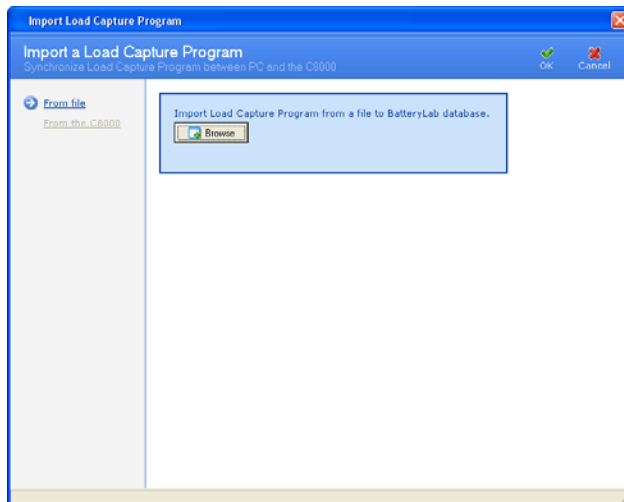
### 3.11.6 Import a Load Capture Program

To import a load capture program from a file:

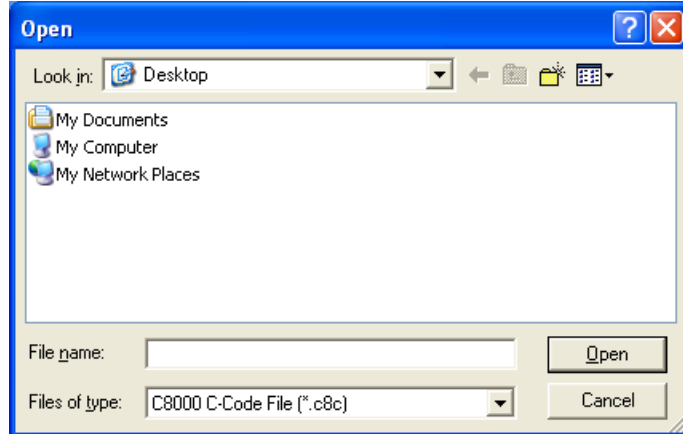
1. From the **Database** menu, click **Load Capture**. The **Program Database** window appears.



2. Click **Import**. The **Import a Load Capture Program** window appears.



- Click **Browse**. The **Open** window appears.

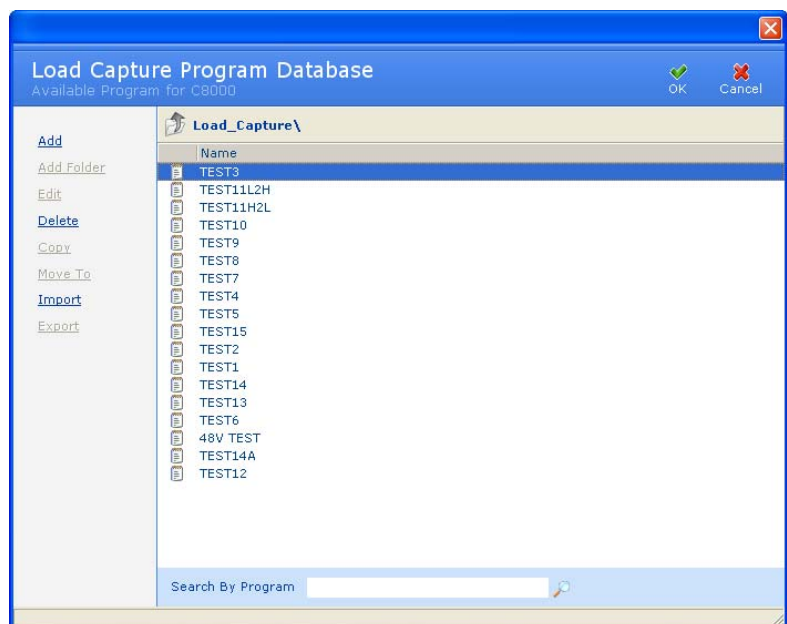


- Select the file to import and click **Open**. The **Information** window appears, showing the number of load capture programs imported. (If the load capture program already exists, click **Cancel** to terminate the import process altogether, or **OK** to overwrite the existing load capture program. Alternatively, specify a different name for the load capture program and click **OK** to import it).

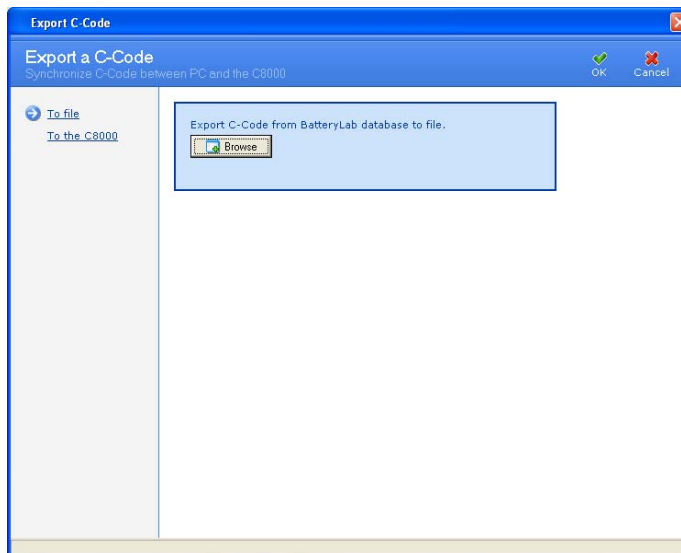
### 3.11.7 Export a Load Capture Program

To export load capture programs to a file:

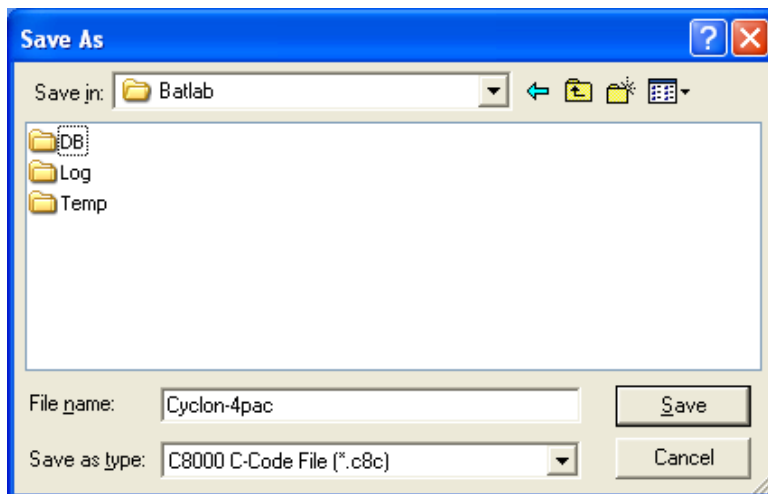
- From the **Database** menu, click **Load Capture**. The **Programs Database** window appears.



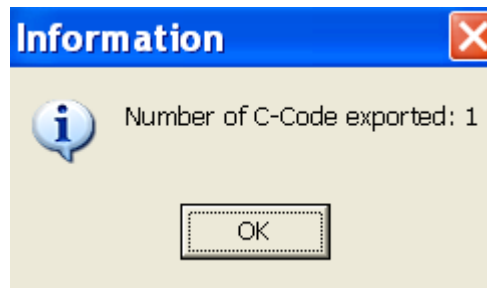
2. Select the load capture program to export. Note that multiple load capture programs can be exported to the same file.
3. Click **Export**. The **Export a Load Capture Program** window appears.



4. Click **Browse**. The **Save As** window appears.



5. Type a name for the file in the *File name* field.
6. Click **Save**. All selected load capture programs are saved to the file. An **Information** window appears with the number of load capture programs exported. (If the file already exists, specify a new filename or opt to overwrite the existing file – click **OK**.)



7. Click **OK**.

---

### 3.11.8 Search for a Load Capture Program

The BatteryLab database may contain hundreds, or even thousands, of load capture programs. To find a load capture program, click the *Search By Program* field to move the cursor to that field.

A search field with a light blue background and a white text input area. The text 'Search By Program' is displayed in blue on the left side of the field.

Search By Program

Next, type the first one or two characters of the load capture program's name to find. As BatteryLab locates the partial load capture program, it will highlight the corresponding c-code in the **Program Database** window.

---

### 3.11.9 Sort the Load Capture Programs

The BatteryLab database may contain many load capture programs. To sort the load capture programs in ascending order, click the *Name* column in the **Program Database** window. Click the column a second time to sort the load capture programs in descending order.

---

## 3.12 Waveforms

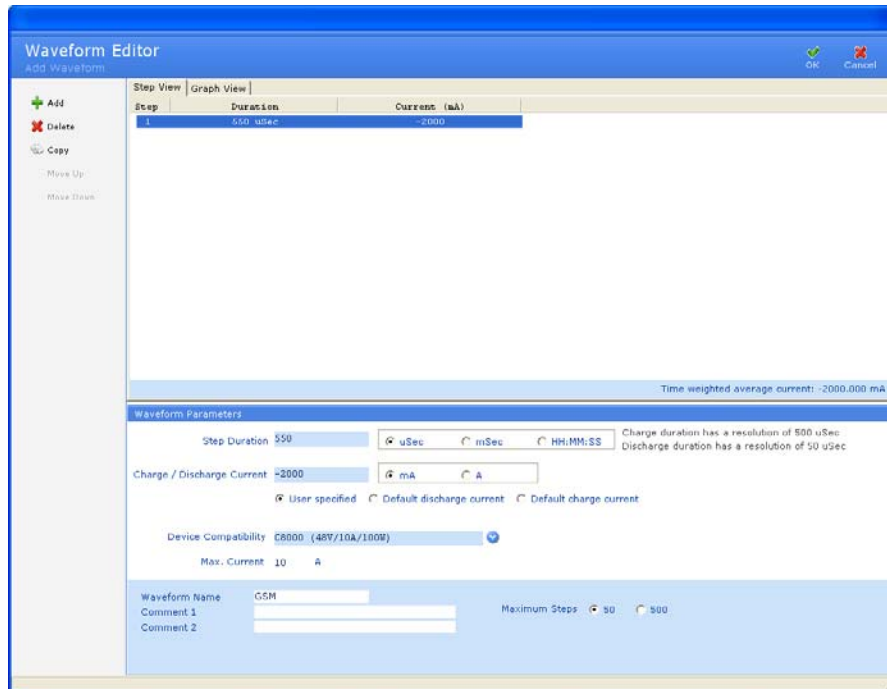
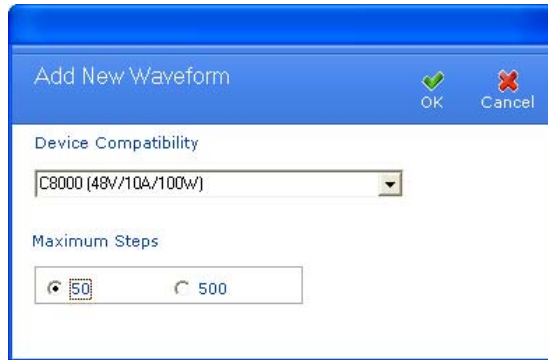
The **Waveforms** window lists the custom waveforms available to the C8000. For each waveform, the **Waveforms Database** window shows the waveform's name. A waveform contains one or more steps that will be executed in the order specified and will be continuously repeated until a program termination has occurred.

---

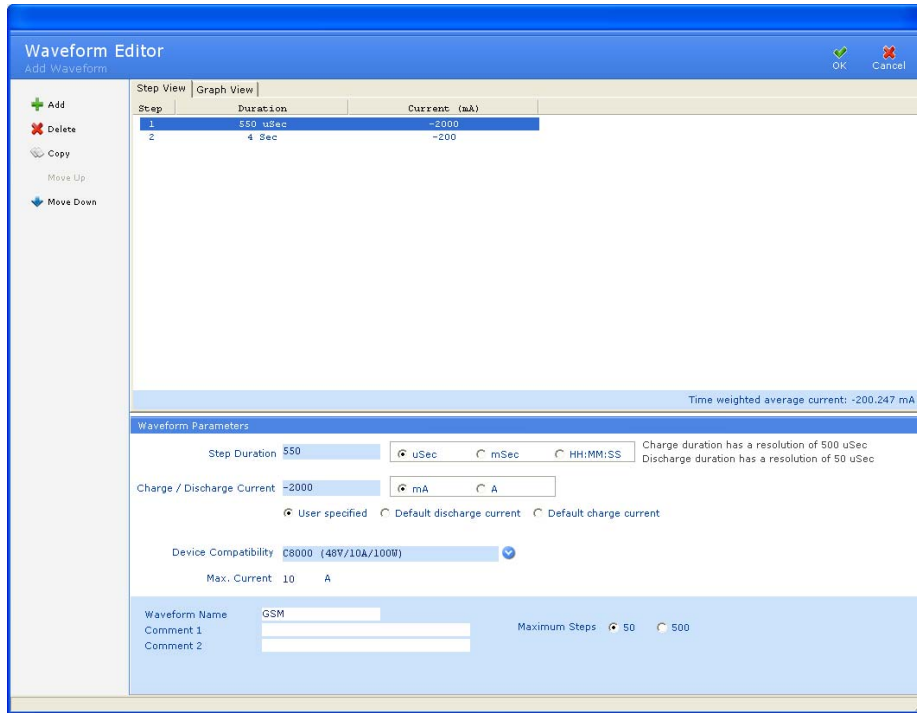
### 3.12.1 Sample Custom Waveform

The following shows how to create a custom waveform for one variable of GSM pulse. In this waveform, we create a 2A load on

the battery for 550 us and a 200 mA load for 4 ms. First; select the device compatibility and the maximum steps.

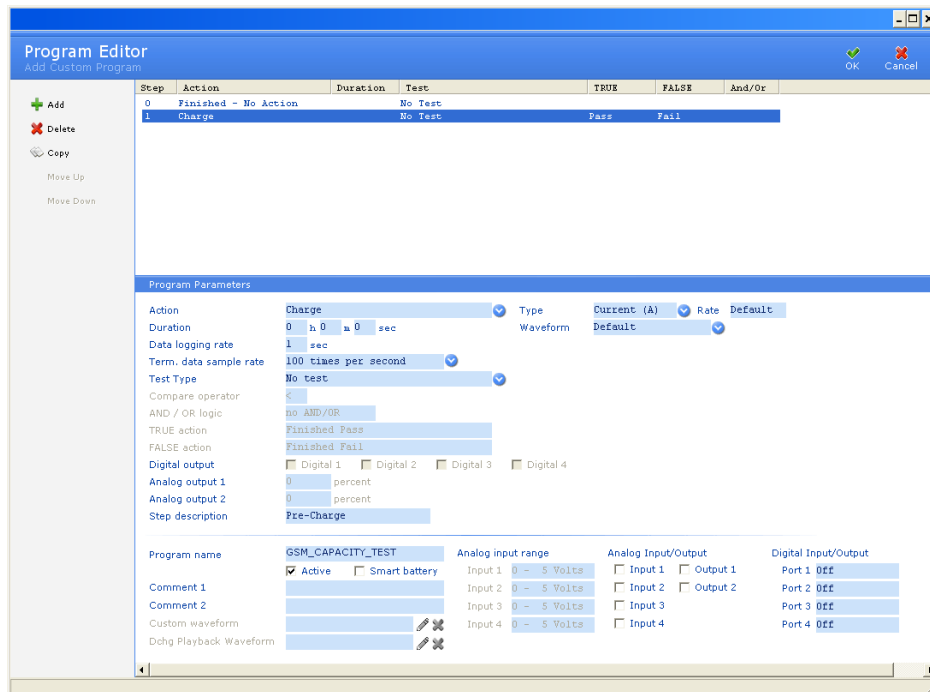


**Step 5 - 550 us load @ 2A**

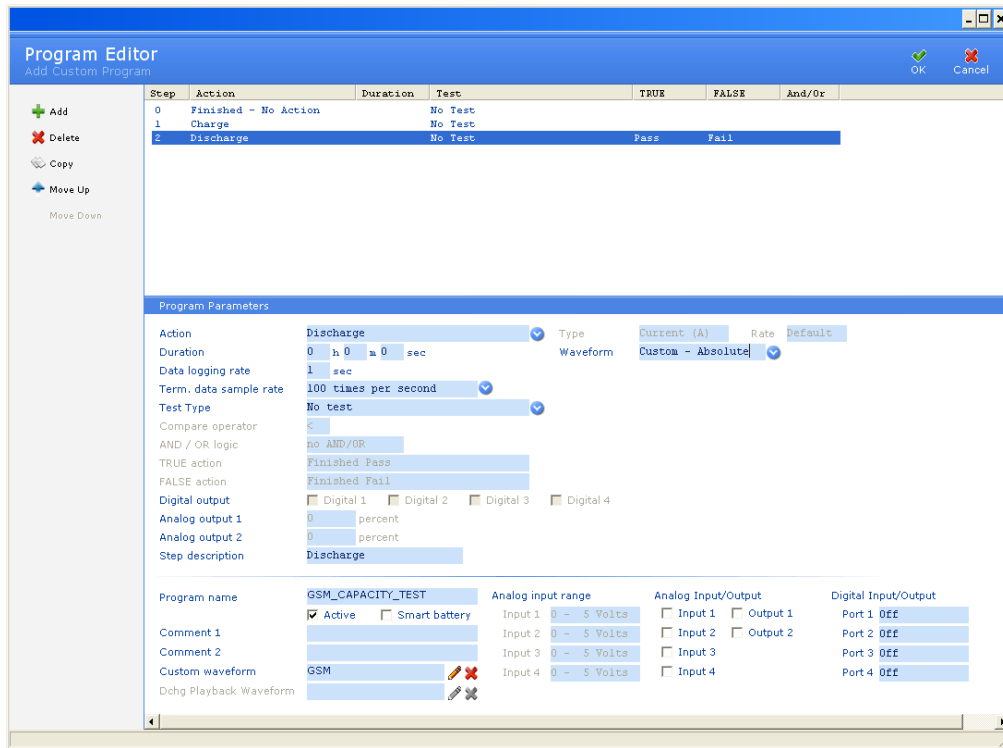


**Step 6 - 4 ms load @ 200 mA**

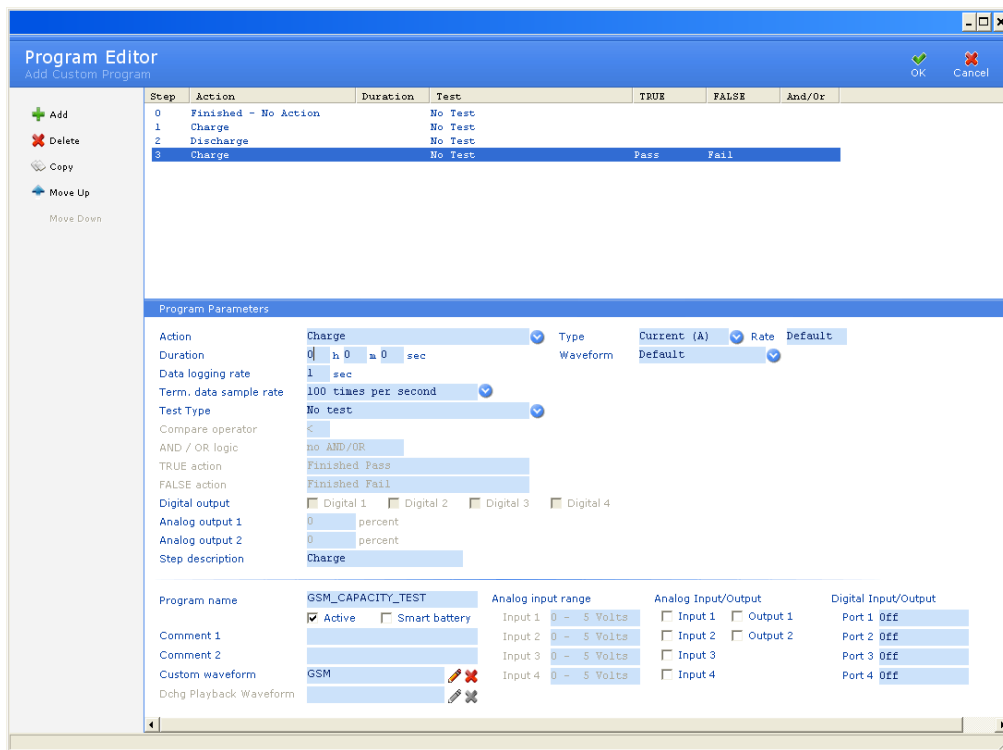
Once a GSM waveform is created, it can be used in a custom program. The following program will charge the battery, discharge the battery using a GSM waveform, and then charge the battery back up.



**Step 7- charge the battery**



Step 8 - discharge using the GSM waveform

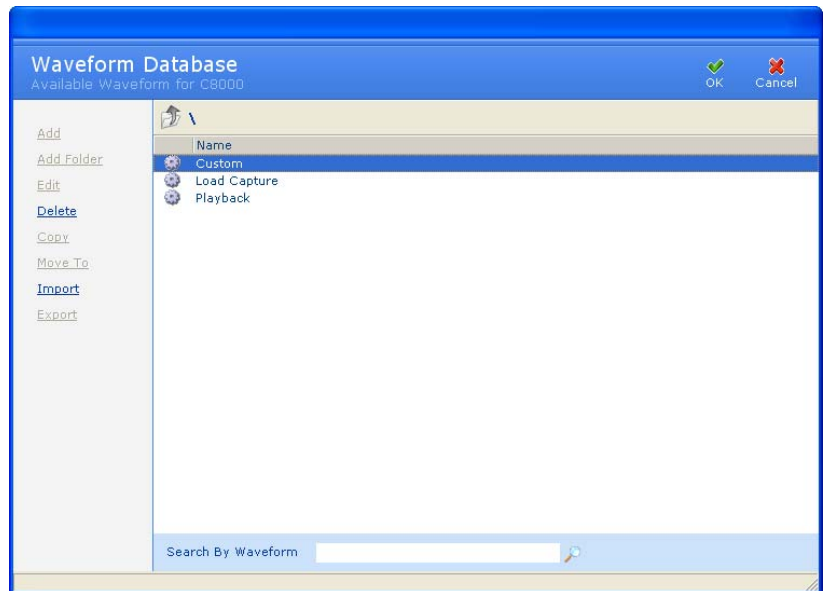


Step 9 - Charge the battery back up

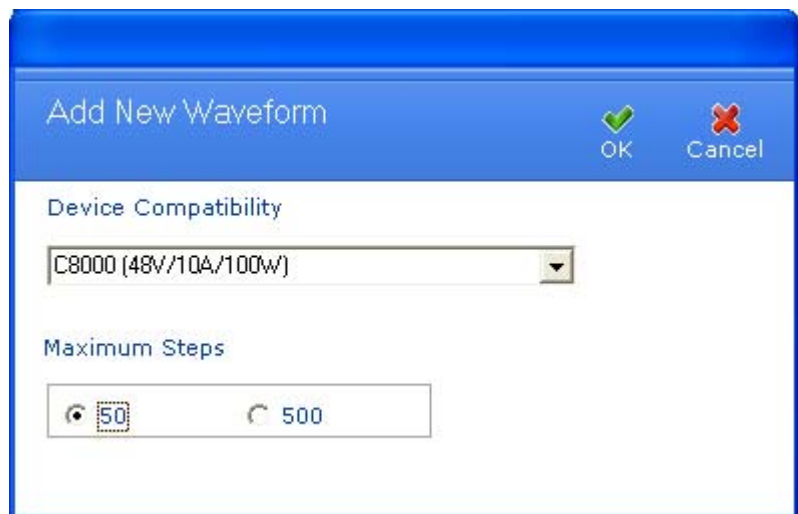
### 3.12.2 Add a Waveform

To add a waveform to BatteryLab:

1. From the **Database** menu, click **Waveforms**. The **Waveform Database** window appears.



2. Select the Custom, Load Capture, or Playback folder and click **Add**. The **Add New Waveform** window appears.



*Explanation:*

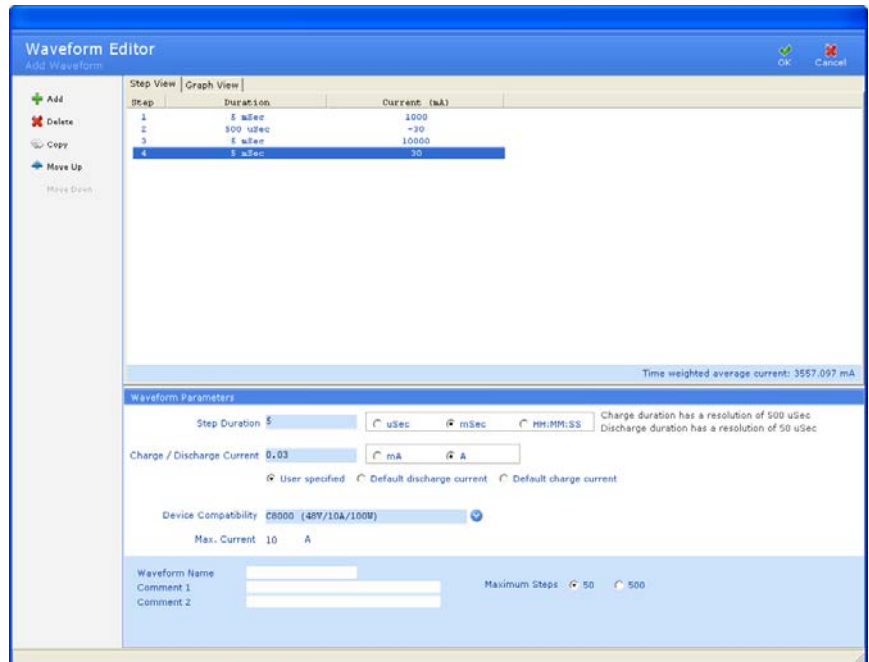
The **Add New Waveform** window is used to configure the waveform. This configuration allows the C8000 system to



recognize the type of waveform that is being created and the intended device where the waveform is to be used.

<b>Add New Waveform</b>	
Device Compatibility	<p>The Device Compatibility option selects the device that the waveform is intended for use.</p> <p>Options available:</p> <p>C8000: supports both charge and discharge steps at 500us intervals. (48V/10A/100W)</p> <p>BK Precision supports only discharge steps at 1ms intervals.</p> <p>Models Supported:</p> <p>8510 - (120V/120A/600W)</p> <p>8514 - (120V/240A/1200W)</p> <p>8518 - (60V/240A/1200W)</p> <p>8520 - (120V/240A/2400W)</p> <p><b>Note:</b> If there is a charge step in a waveform and a BK device has been selected a five second "0" current step is required between the charge and discharge currents. All charge steps will be performed by the C8000.</p>
Maximum Steps	<p>This option sets the maximum number of steps that a waveform will support.</p> <p>50 steps with charge/discharge currents and multiple step durations. (Minimum 500us, Maximum 12hrs per step)</p> <p>500 steps with charge/discharge currents and only a single step duration value for all steps. (Minimum 500us, Maximum 12hrs)</p>

3. Click the DOWN ARROW in the *Device Compatibility* field and select the appropriate entry.
4. Select the *Maximum Steps* for the new waveform. Click **OK**. The **Waveform Editor** window appears.



5. In the *Waveform Name* field, type a name for this waveform.
6. In the *Comment 1* and *Comment 2* fields, type any notes about this waveform.
7. Click **OK**. The new waveform appears in the **Waveform Database** window.

### 3.12.2.1 Add a Step to a Waveform

Note: A zero mA step is required when transitioning between charge/discharge and vice-versa. The last waveform step must respect this rule when it is compared with the first waveform step.

1. Click **Add** in the **Waveform Editor** window. The new step appears in the **Custom Waveform** window.
2. Change the values in the *Duration* and the *Charge/Discharge Current* fields, as needed.

### 3.12.2.2 Remove a Step from a Waveform

1. Select the step to delete.
2. Click **Delete**.

### 3.12.2.3 Copy a Step to Another Step in a Waveform

1. Select the step to copy.
2. Click **Copy**.

### 3.12.2.4 Move the Order of Steps in a Waveform

To move the position of a step up or down in the waveform, click the field name and then click **Move Up** or **Move Down**. This sets the order that the steps will be executed in the waveform.

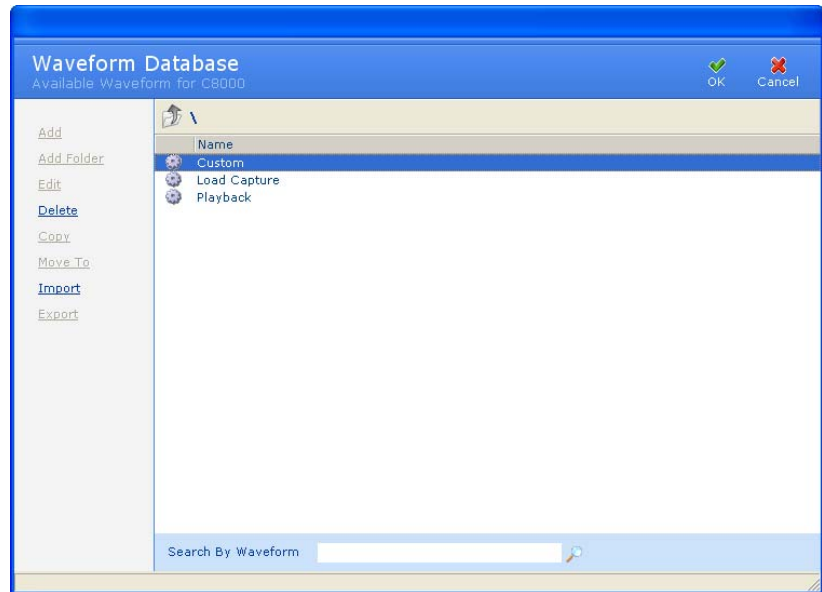
### 3.12.3 Organize Waveforms in Folders

Waveforms can be organized, or grouped, into folders. The Waveforms database is divided into three groups. A sub-group can be created within each of these three groups. The following table describes the Waveform groups:

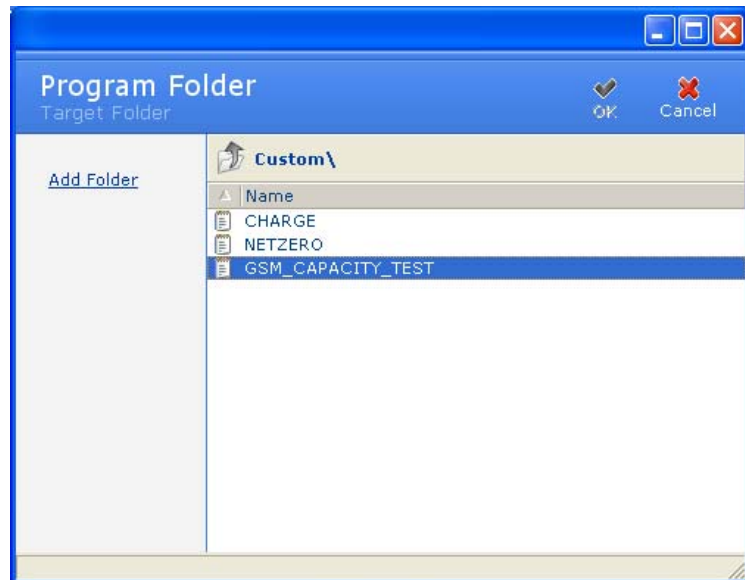
Group Name	Description
Custom	<p>All standard supported waveforms. Two types of waveforms are categorized as custom waveforms:</p> <p>Waveform #1: Maximum 50 steps with charge/discharge steps of any duration. (Minimum 500s, Maximum 12hrs)</p> <p>Waveform #2: Maximum 500 steps with charge/discharge steps with a single duration for each step. (Minimum 500us, Maximum 12hrs)</p>
Load Capture	<p>Displays all captured waveforms from the accessory Load Capture Unit. Waveforms cannot be manually added to this group. All other functions are available.</p>
Playback	<p>Discharge waveforms supported only. No charge pluses are allowed within this group. Only one type of waveform is categorized as playback waveforms:</p> <p>Waveform #1: Maximum 500 steps, with discharge steps with a single duration for each step. (Minimum 500us, Maximum 12hrs)</p>

To move a waveform to a folder:

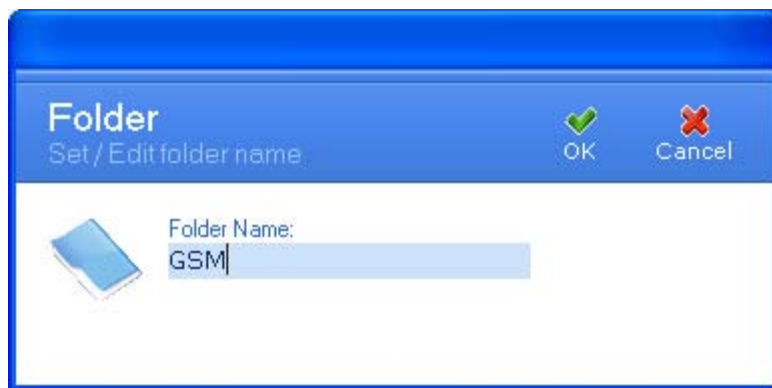
- From the **Database** menu, click **Waveforms**. The **Waveform Database** window appears.



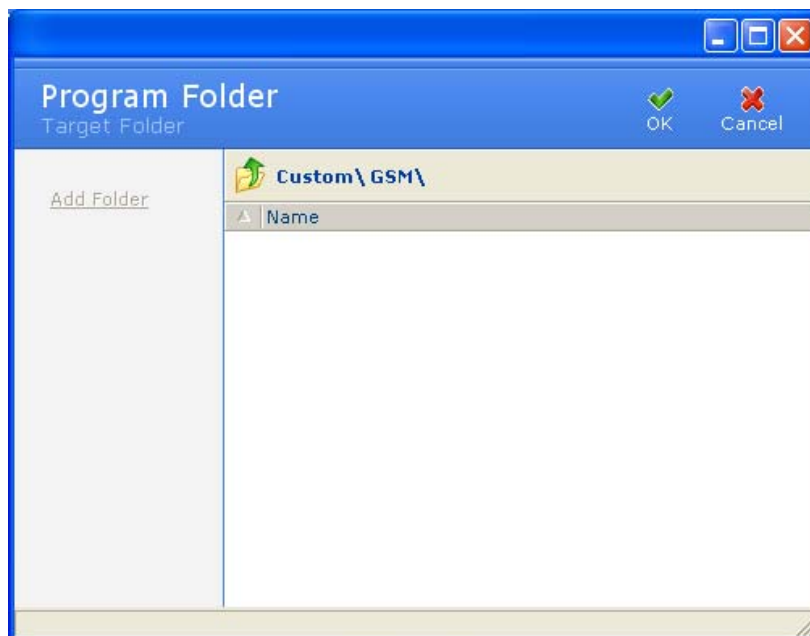
7. Select the waveform (identified by a text document icon) to move to a folder.
8. Click **Move To**. The **Target Folder** window appears.



9. If necessary, create a folder by clicking **Add Folder**.



10. Double-click the name of the folder to move the waveform to. The target folder appears.



11. Click **OK**. The waveform is moved to the target folder.

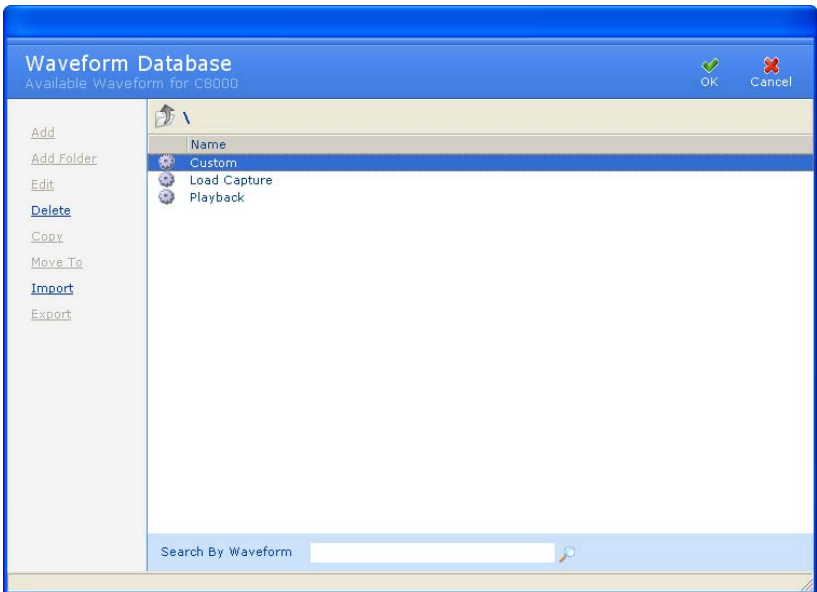
**Note:** Waveforms cannot be moved from one group to another. The Load Capture Waveforms can be converted from a Load Capture waveform to a Playback Waveform.

---

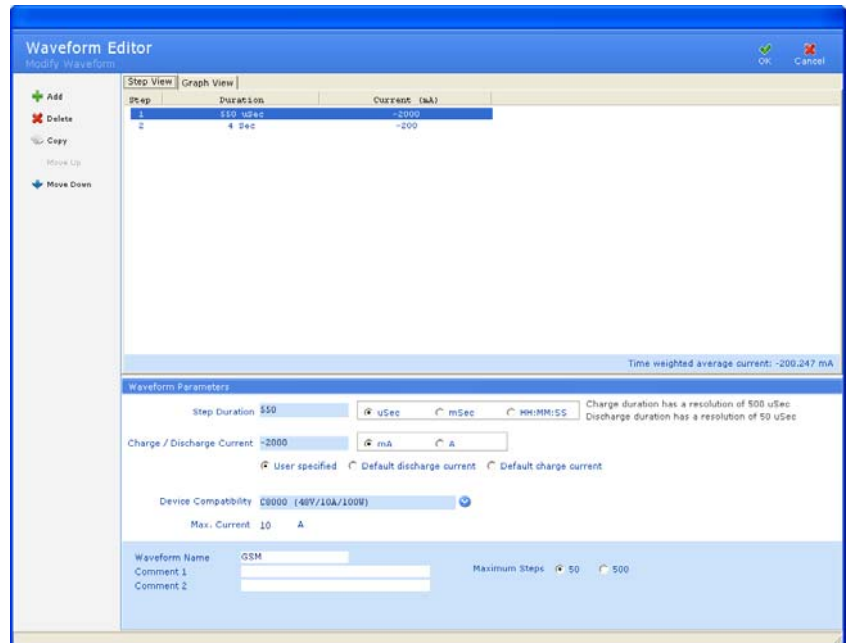
### 3.12.4 Edit a Waveform

To change the information for a waveform:

1. From the **Database** menu, click **Waveforms**. The **Waveform Database** window appears.



2. Select the waveform to edit.
3. Click **Edit**. The **Waveform Editor** window appears.

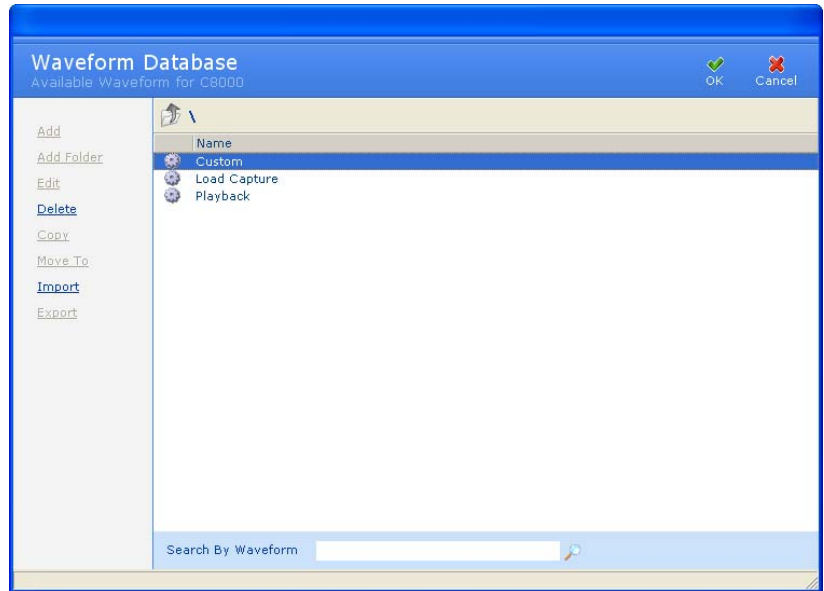


4. Edit the information for the waveform, as required.
5. Click **OK**.

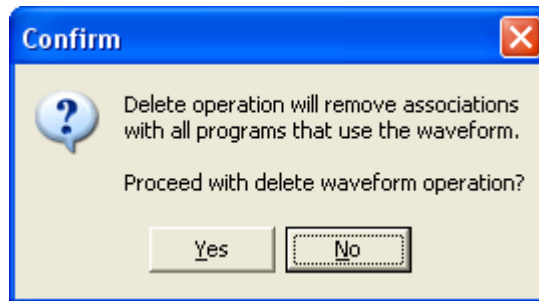
### 3.12.5 Delete a Waveform

To delete a custom waveform:

1. From the **Database** menu, click **Waveforms**. The **Waveform Database** window appears.



2. Select the waveform to delete.
3. Click **Delete**. The **Delete Options** window appears. To delete the waveform from BatteryLab, select the *Delete From BatteryLab* check box. To delete the waveform from the connected C8000, select the *Delete From Connected C8000* check box. Click **OK**.
4. The **Confirm** window appears.



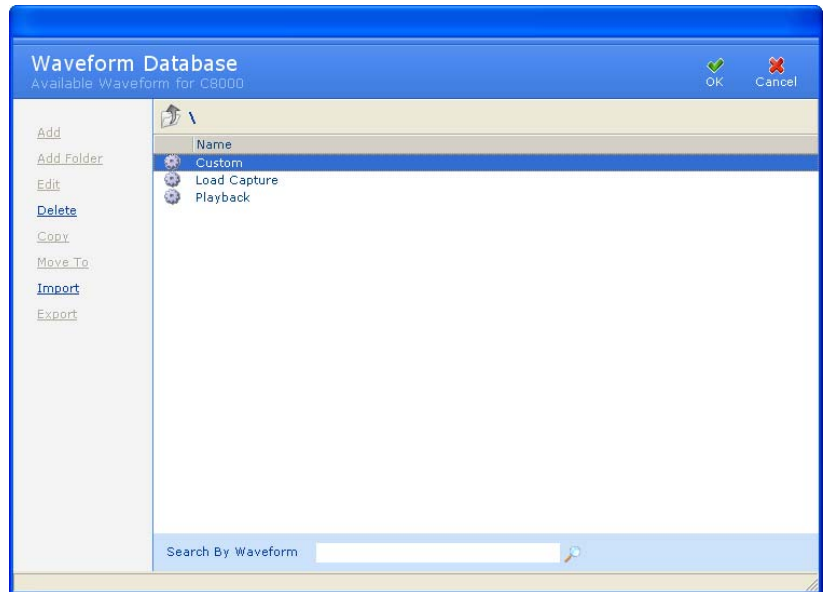
5. Click **Yes**.

---

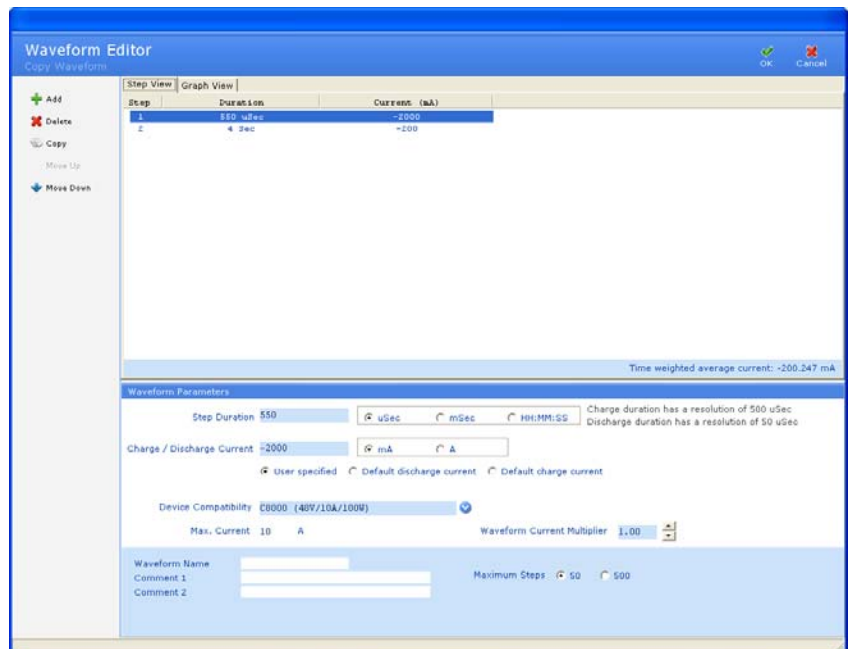
### 3.12.6 Copy a Waveform

To create a waveform from an existing waveform:

1. From the **Database** menu, click **Waveforms**. The **Waveform Database** window appears.



2. Select the waveform to copy.
3. Click **Copy**. The **Waveform Editor** window appears.



4. Type a name for the new waveform in the *Waveform Name* field.
5. Type any notes in the *Comment 1* and *Comment 2* fields, as required.
6. Add, delete, or copy steps for this waveform, as required.

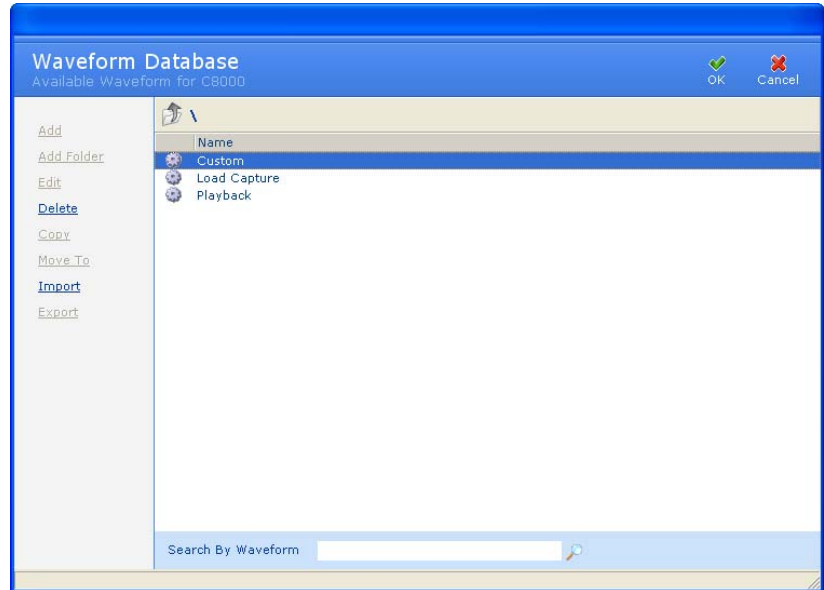


7. Click **OK**. The new waveform appears in the **Waveform Database** window.

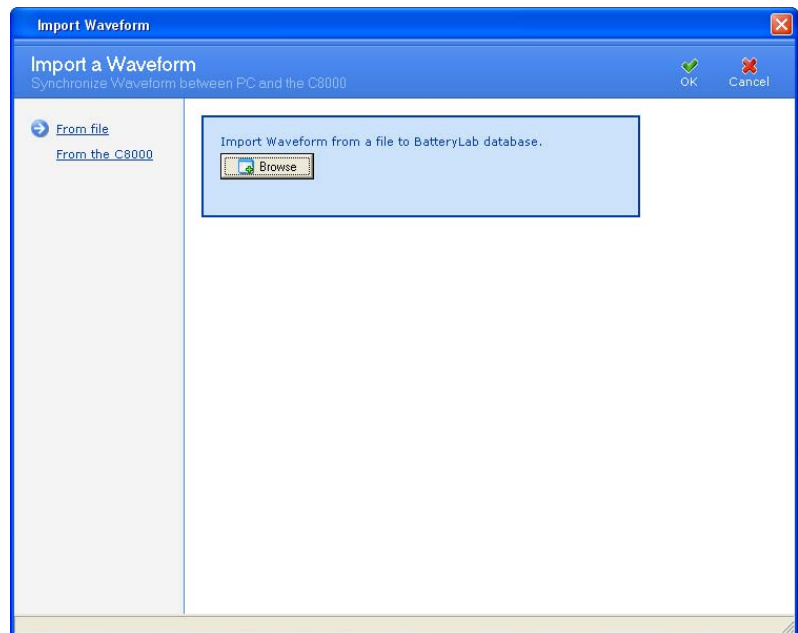
### 3.12.7 Import a Waveform

To import a waveform from a file:

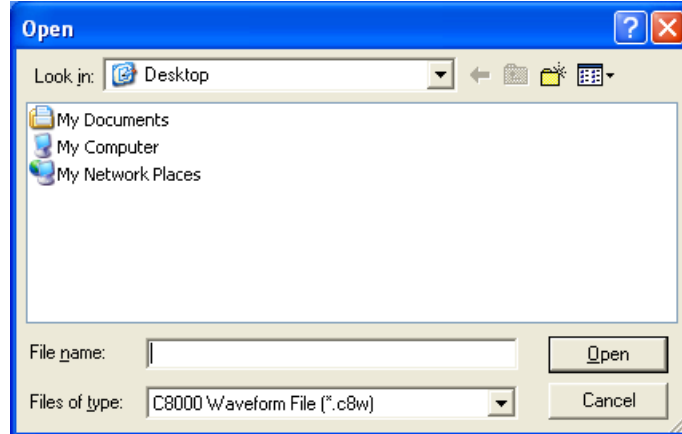
1. From the **Database** menu, click **Waveforms**. The **Waveform Database** window appears.



2. Click **Import**. The **Import a Waveform** window appears.



3. Click **Browse**. The **Open** window appears.

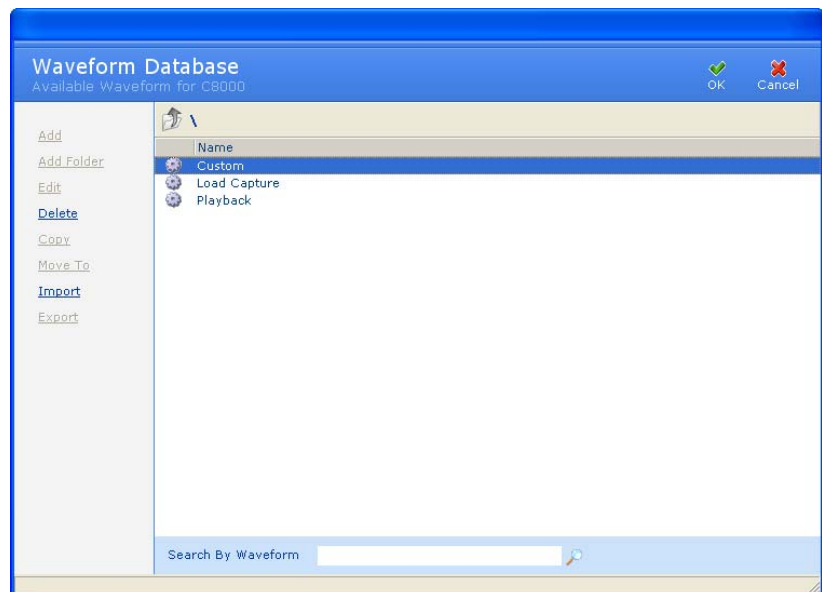


4. Select the waveform file to import and click **Open**. Note that a file may contain multiple waveforms. The **Information** window appears with the number of waveforms imported. (If the waveform already exists, click **Cancel** to terminate the import process altogether, or **OK** to overwrite the existing waveform. Alternatively, specify a different name for the waveform and click **OK** to import it.)

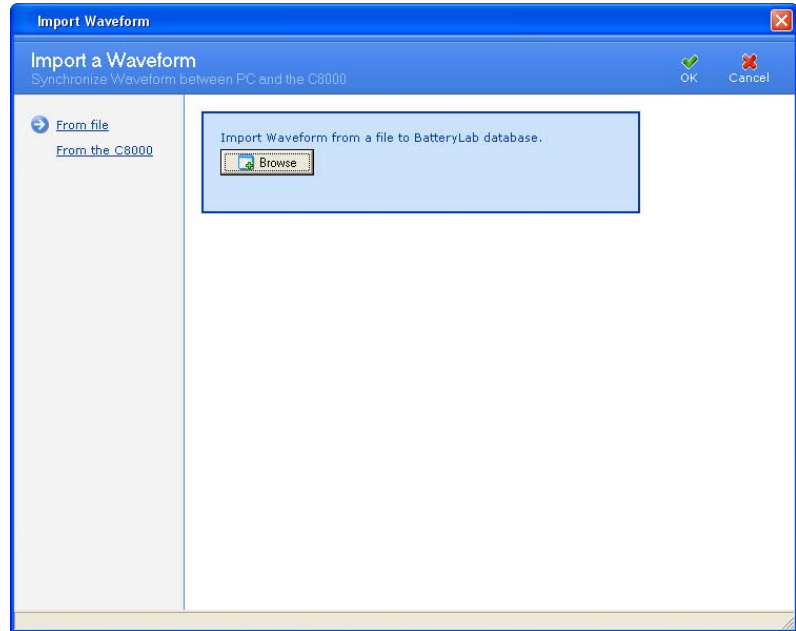
To import a waveform from the C8000:

**Note:** Load Capture Waveforms cannot be imported from a C8000.

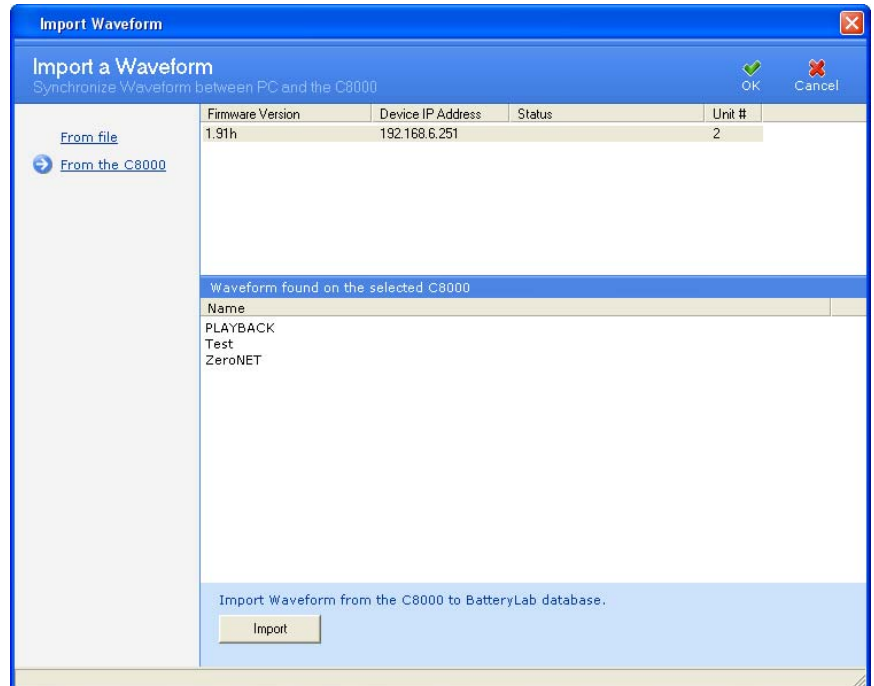
1. From the **Database** menu, click **Waveforms**. The **Waveform Database** window appears.



- Click **Import**. The **Import a Waveform** window appears.



- Click **From the C8000**. The window updates with a list of connected C8000s and available waveforms for the selected C8000.

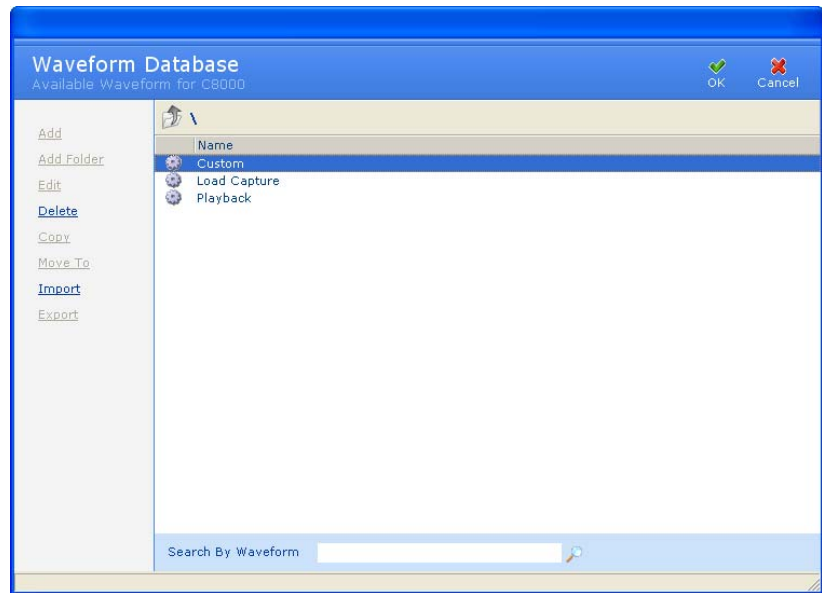


- Select the waveform to import.
- Click **Import**. The **Information** window appears with the number of waveform files imported.

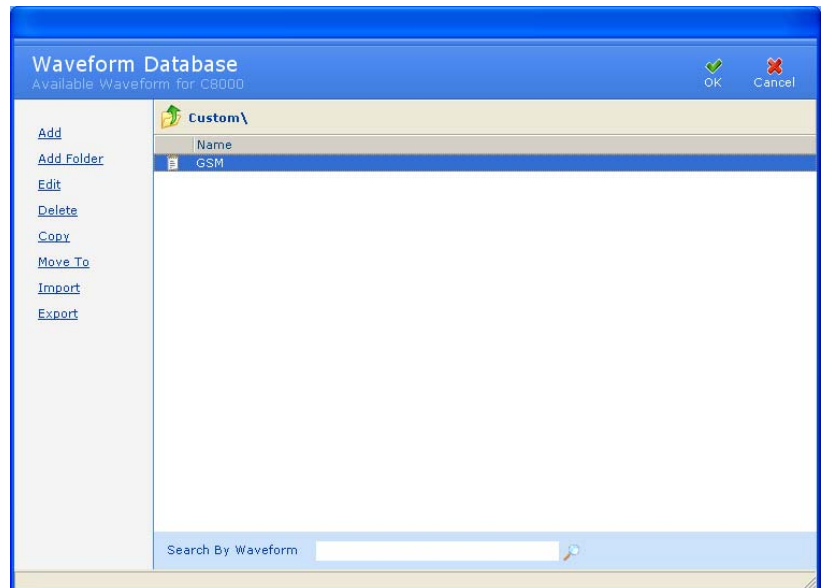
### 3.12.8 Export a Waveform

To export a waveform to a file:

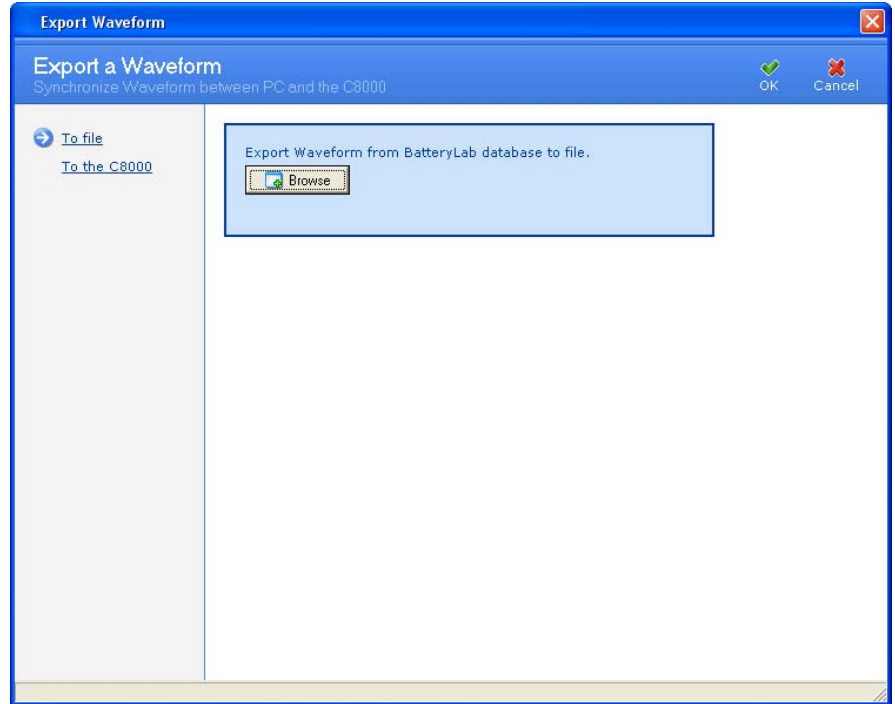
1. From the **Database** menu, click **Waveforms**. The **Waveform Database** window appears.



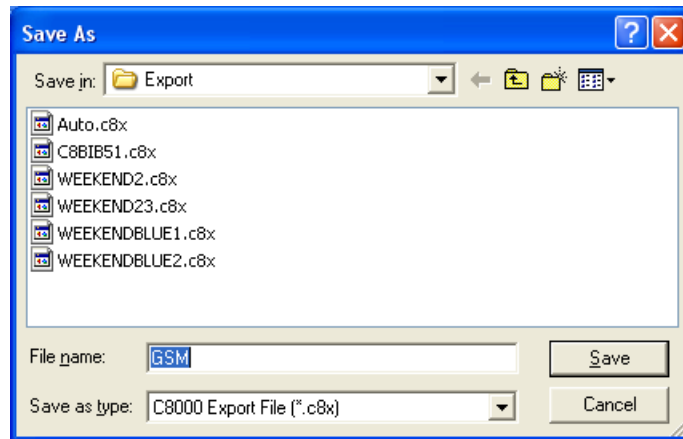
2. Select the waveform to export.
3. Click **Export**. The **Available Waveforms for C8000** window appears.



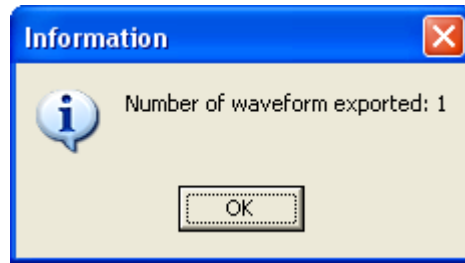
4. Select the folder to export the waveforms to and click **Export**.



5. Click **Browse**. The **Save As** window appears.



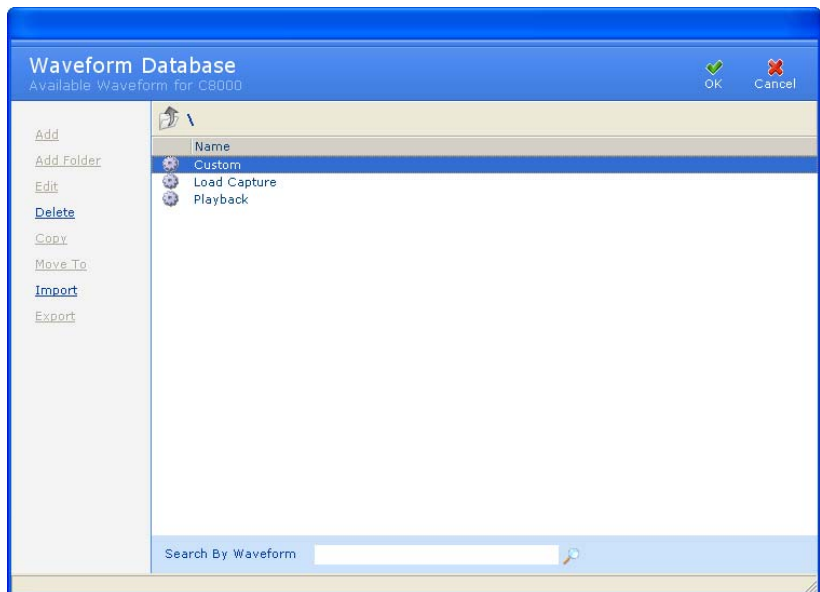
6. Type a name for the export file in the *File Name* field.
7. Click **Save**. The **Information** window appears with the number of waveforms exported to the file.



8. Click **OK**.

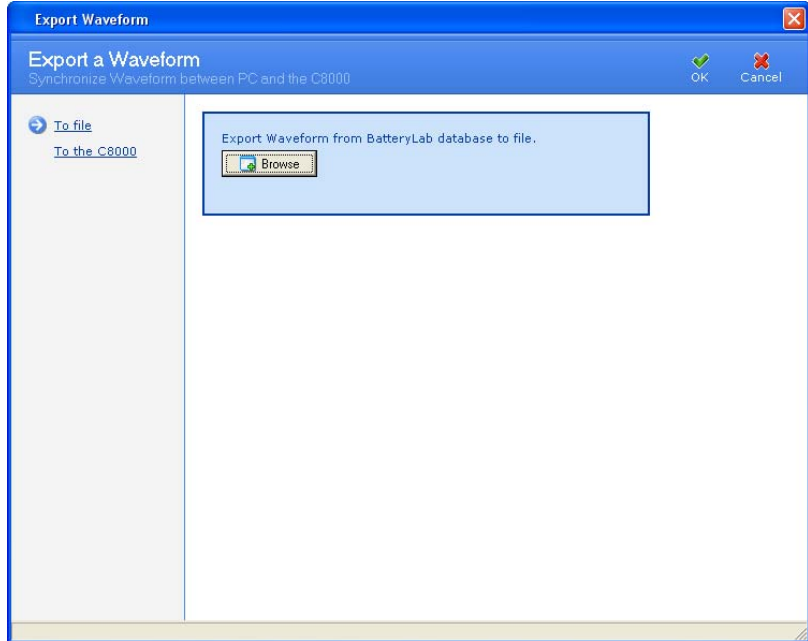
To export a waveform to the C8000:

1. From the **Database** menu, click **Waveforms**. The **Waveform Database** window appears.

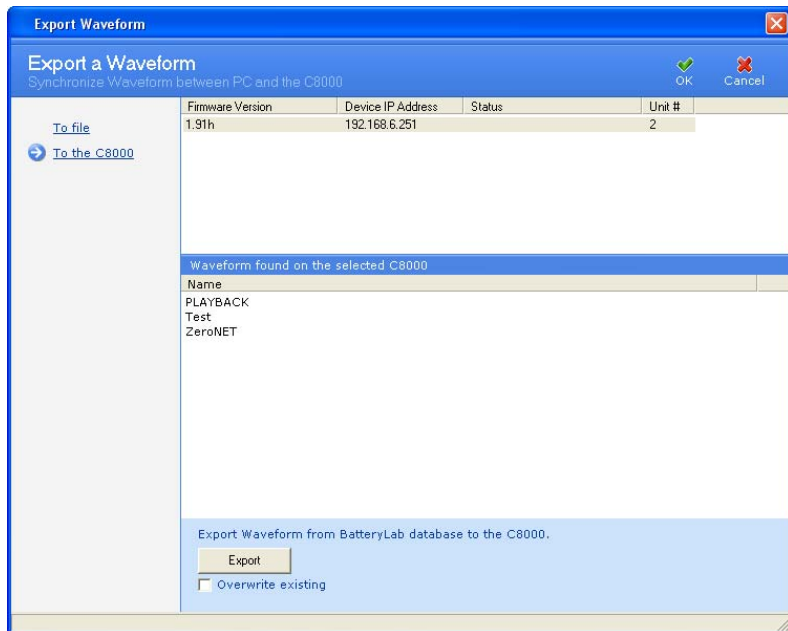


2. Select the waveform to export.

3. Click **Export**. The **Export a Waveform** window appears.



4. Click **To the C8000**. The window updates with a list of connected C8000s.



5. Click **Export**. The **Information** window appears with the number of waveforms exported.

### 3.12.9 Search for a Waveform

The BatteryLab database may contain many waveforms. To find a specific waveform, click the *Search By Waveform* field to move the cursor to that field.



Next, type the first one or two characters of the waveform you want to find. As BatteryLab locates the partial waveform, it will highlight the corresponding waveform's name in the **Waveform Database** window.

---

### 3.12.10 Sort the Waveforms

The BatteryLab database may contain many waveforms. To sort the waveforms in ascending order, click the *Name* column in the **Waveform Database** window. Click the column a second time to sort the waveforms in descending order.

---

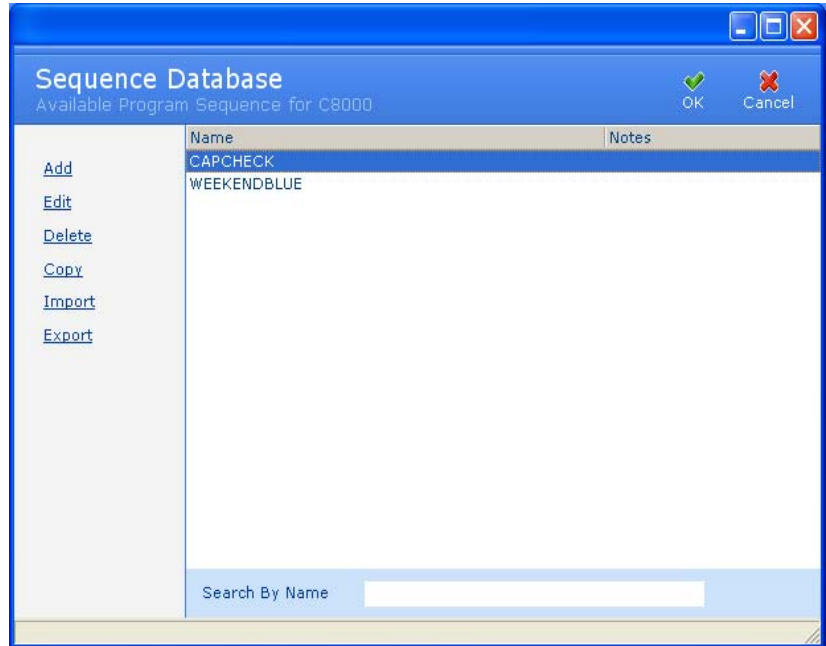
## 3.13 Sequences

Programs may contain one or more program steps. The **Sequence Database** identifies the order the steps in a program will be executed. The **Sequence Database** window displays the program step's name and any corresponding notes about the program step.

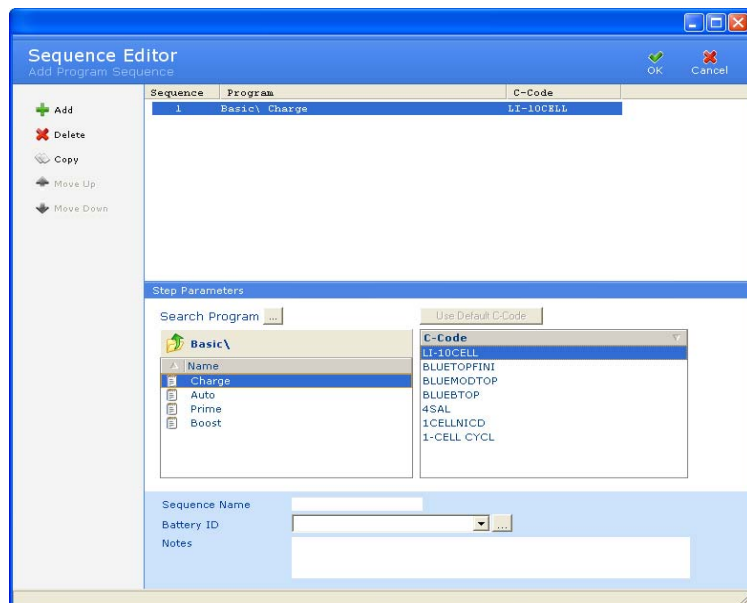


### 3.13.1 Add a Program Sequence

1. From the **Database** menu, click **Sequencer**. The **Sequence Database** window appears.



2. Click **Add**. The **Add Program Sequence** window appears.



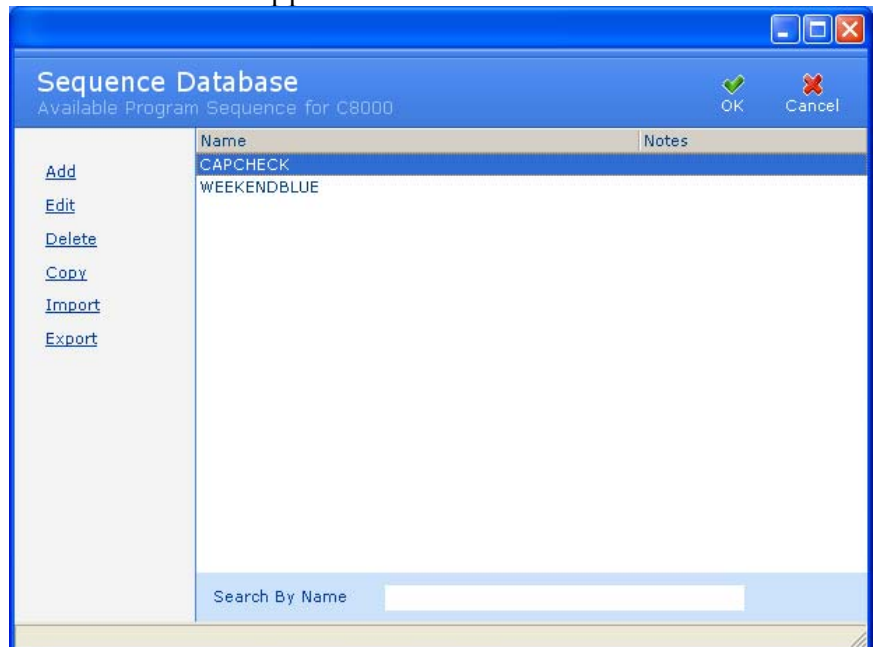
3. Select the program to add the program sequence to. Next, select the C-Code for that program.
4. Type a name for the program sequence in the *Sequence Name* field.

5. Click the **DOWN ARROW** in the *Battery ID* field and select a battery ID.
6. Type any remarks in the *Notes* field.
7. Click **OK**. The new program sequence appears in the **Sequence Database** window.

### 3.13.2 Edit a Program Sequence

To edit a program sequence:

1. From the **Database** menu, click **Sequencer**. The **Sequence Database** window appears.

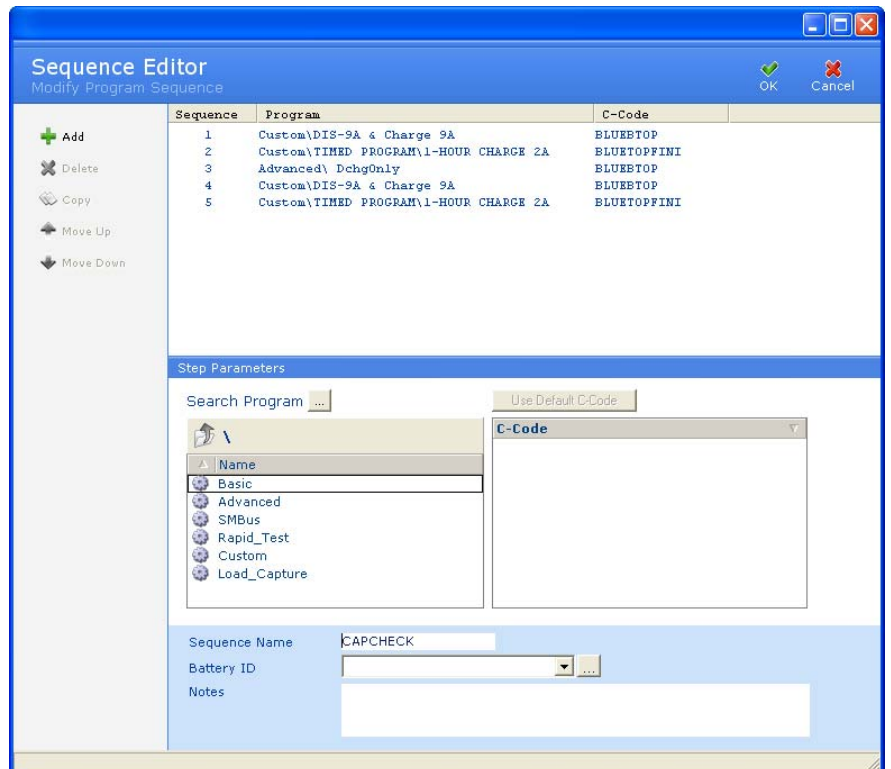


2. Select the program sequence to edit.

3. Click **Edit**. If database security is enabled, the **Password** window appears.



4. Enter your password and click **OK**. The **Modify Program Sequence** window appears.



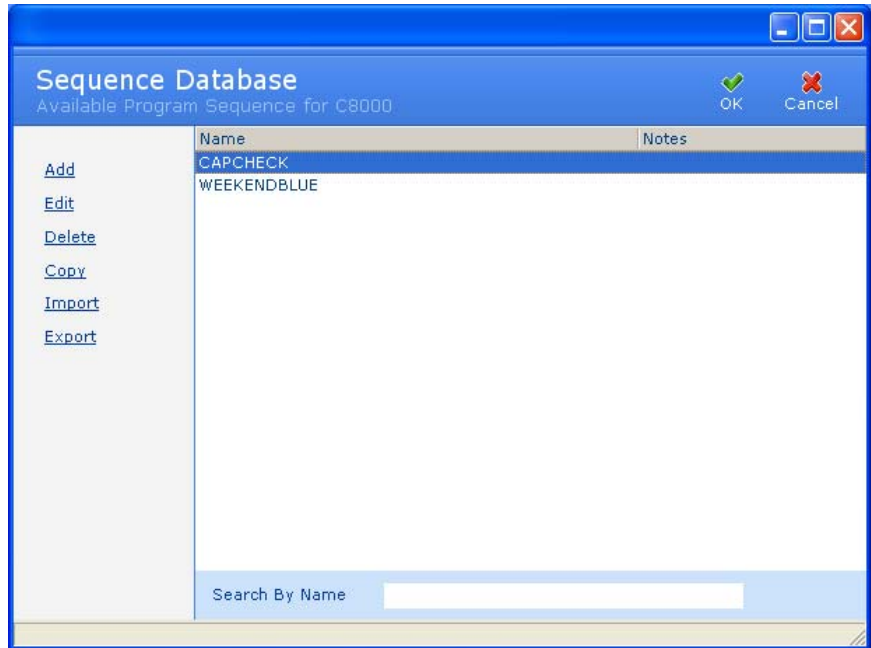
5. Edit the information, as required.

6. Click **OK**.

### 3.13.3 Delete a Program Sequence

To delete a program sequence:

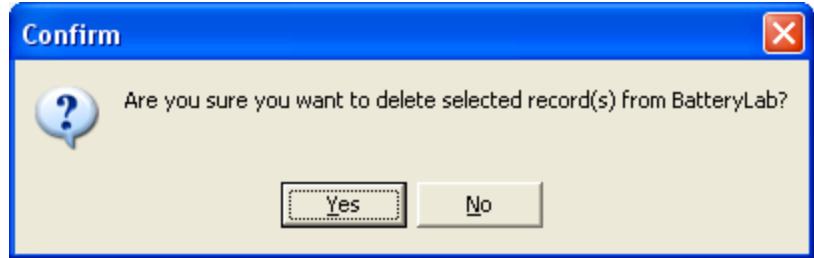
1. From the **Database** menu, click **Sequencer**. The **Sequence Database** window appears.



2. Select the program sequence to delete.
3. Click **Delete**. If database security is enabled, the **Password** window appears.



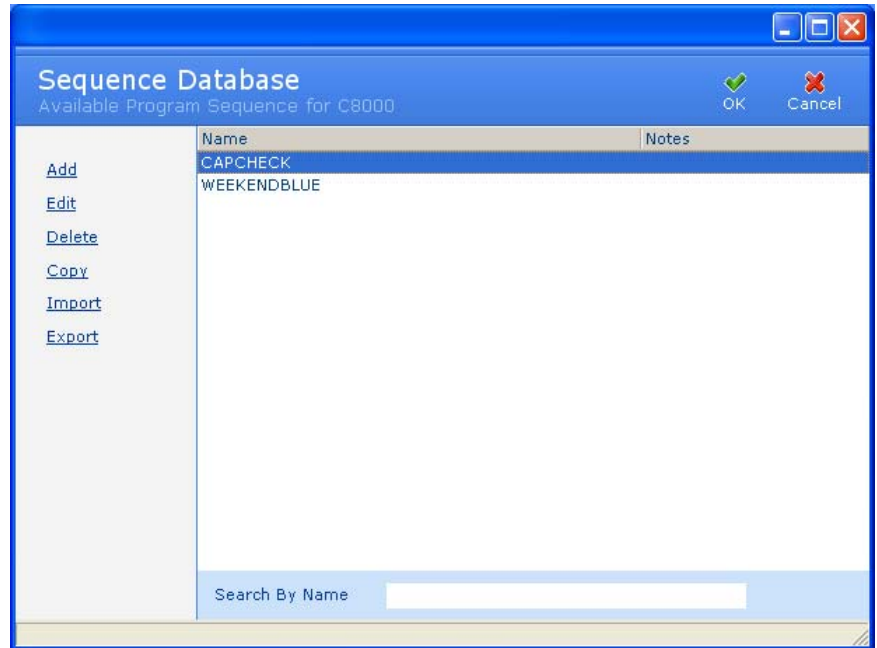
4. Enter your password and click **OK**. The **Confirm** window appears. Click **Yes** to delete the program sequence.



### 3.13.4 Copy a Program Sequence

Copy a program sequence to create a program sequence:

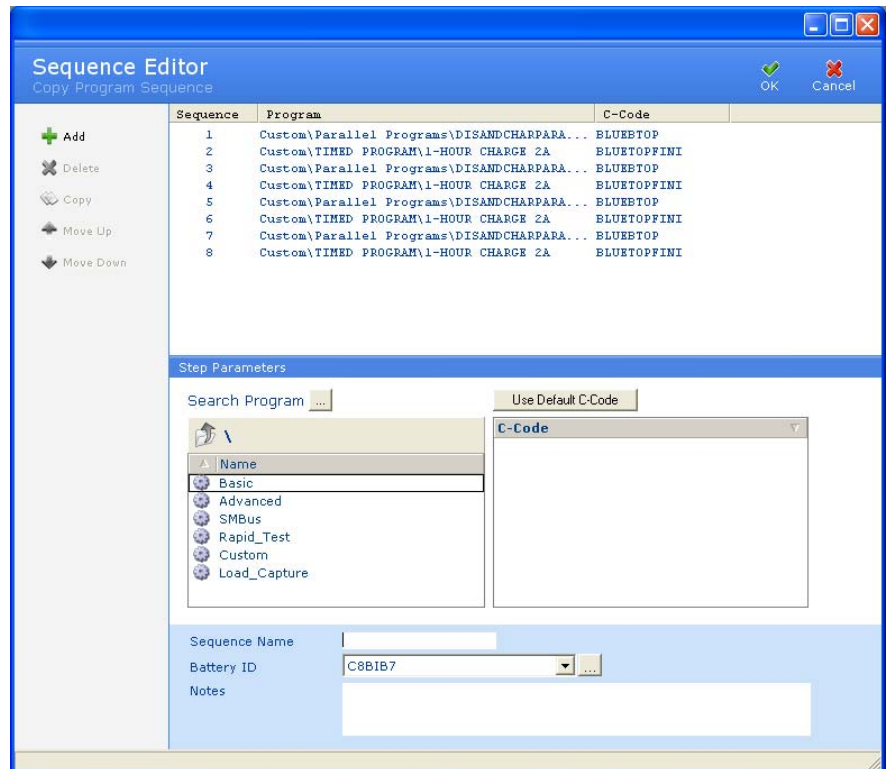
1. From the **Database** menu, click **Sequencer**. The **Sequence Database** window appears.



2. Select the program sequence to copy.
3. Click **Copy**. If database security is enabled, the **Password** window appears.



4. Enter your password and click **OK**. The **Copy Program Sequence** window appears.

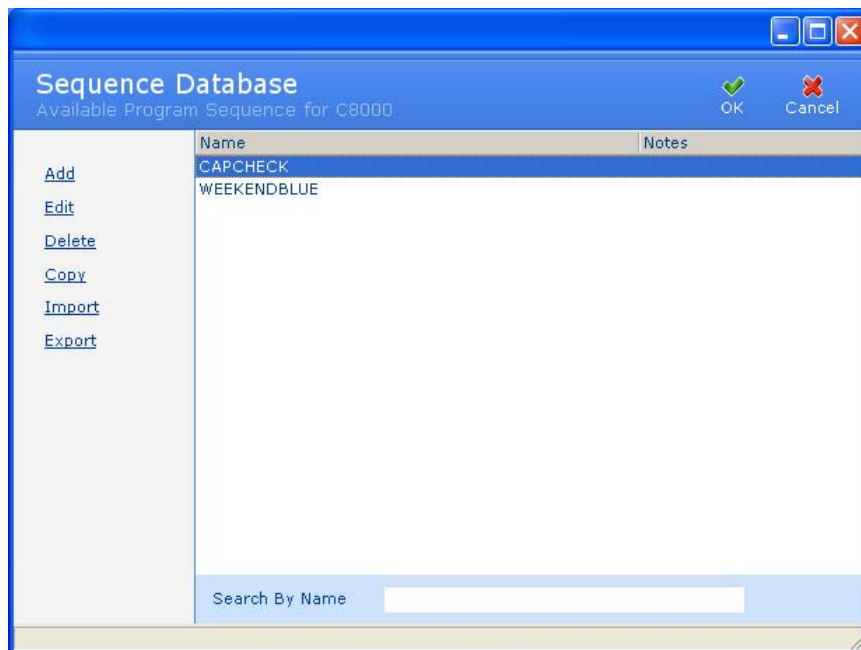


5. In the *Sequence Name* field, type a name for the new sequence.
6. Click **OK**. The new program sequence appears in the **Sequence Database** window.

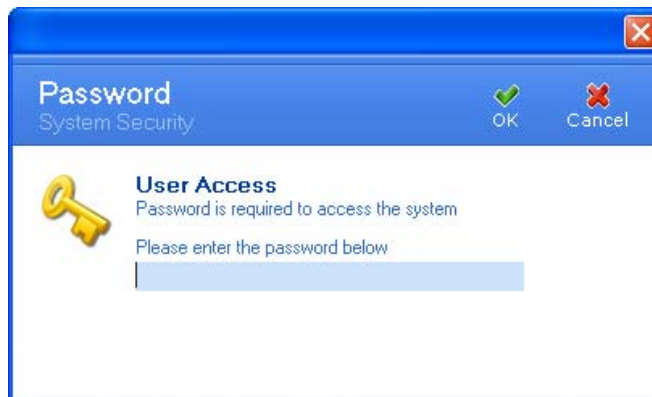
### 3.13.5 Import a Program Sequence

To import a program sequence from a file:

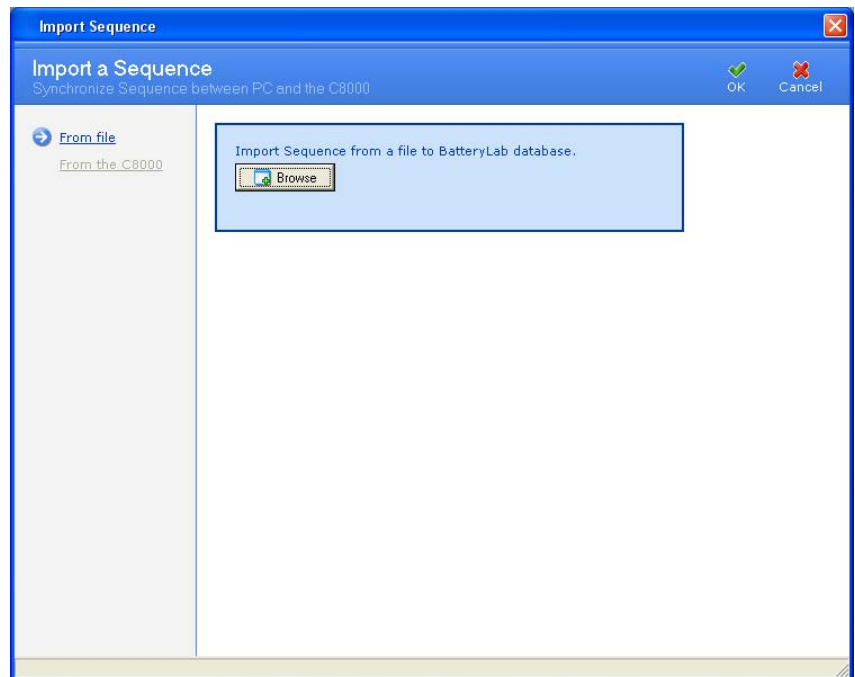
1. From the **Database** menu, click **Sequencer**. The **Sequence Database** window appears.



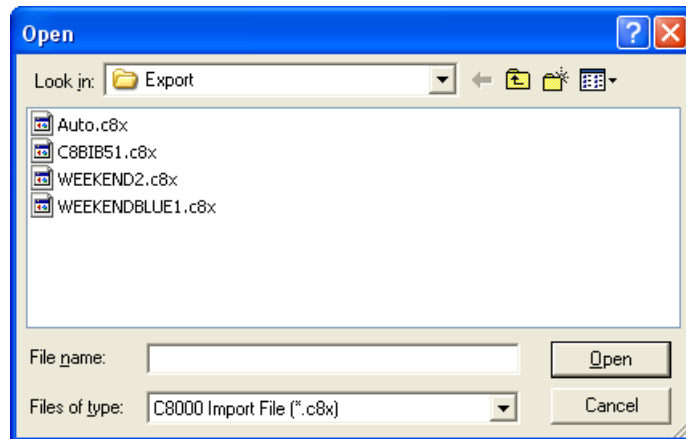
2. Click **Import**. If database security is enabled, the **Password** window appears.



3. Enter your password and click **OK**. The **Import a Sequence** window appears.

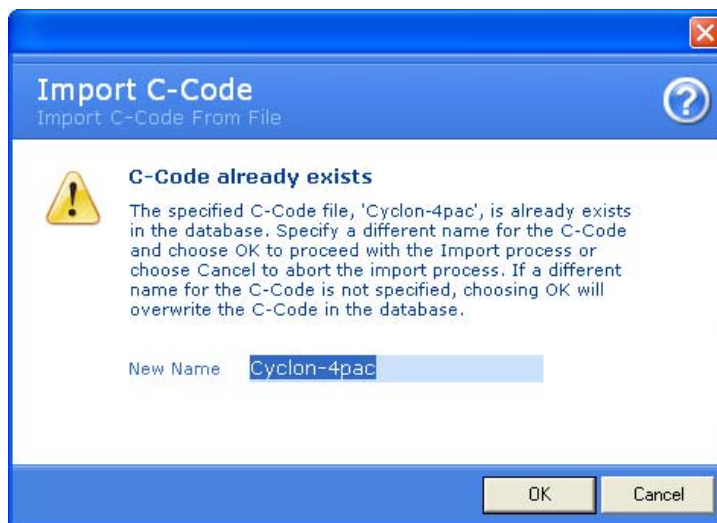


4. Click **Browse**. The **Open** window appears.

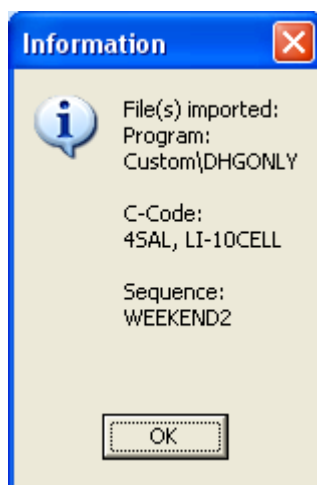


5. Select the file that contains the program sequence to import.
6. Click **Open**. If the c-code specified in the to-be-imported file already exists, this error window will appear. Type a new name for the c-code and click **OK**.



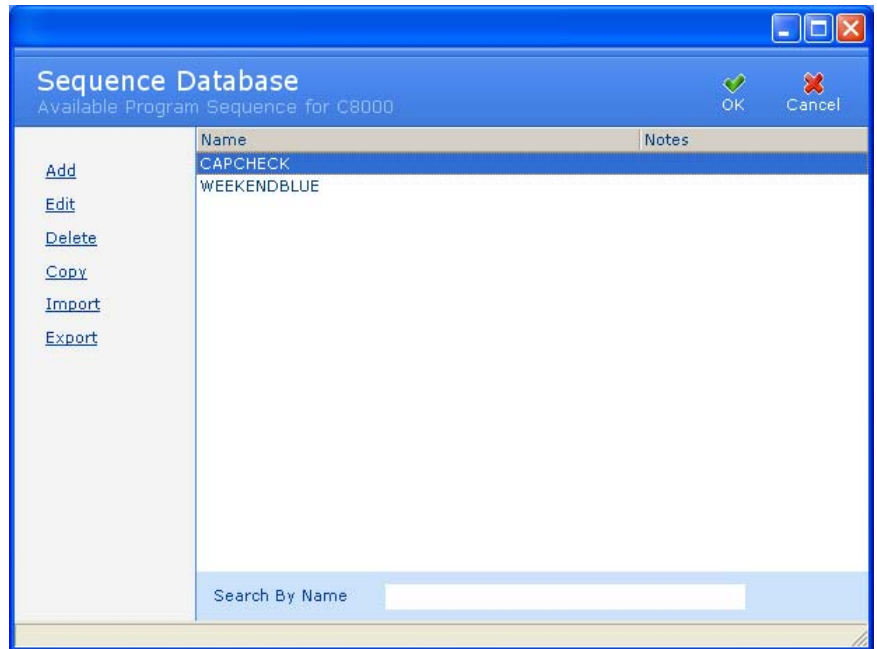


7. An **Information** window appears with the number of program sequences imported.



To import a program sequence from the C8000:

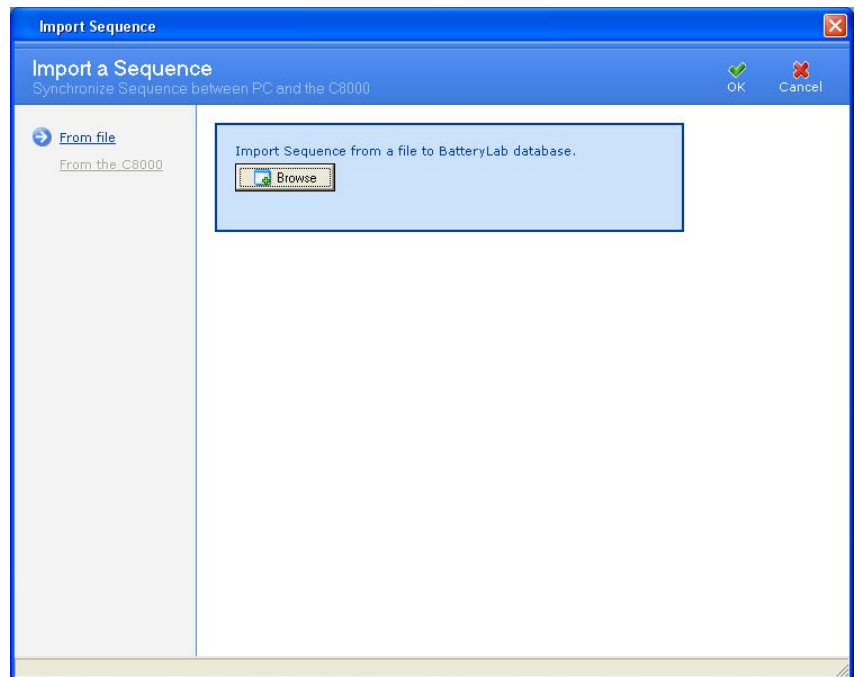
1. From the **Database** menu, click **Sequencer**. The **Sequence Database** window appears.



2. Click **Import**. If database security is enabled, the **Password** window appears.



3. Enter your password and click **OK**. The **Import a Sequence** window appears.



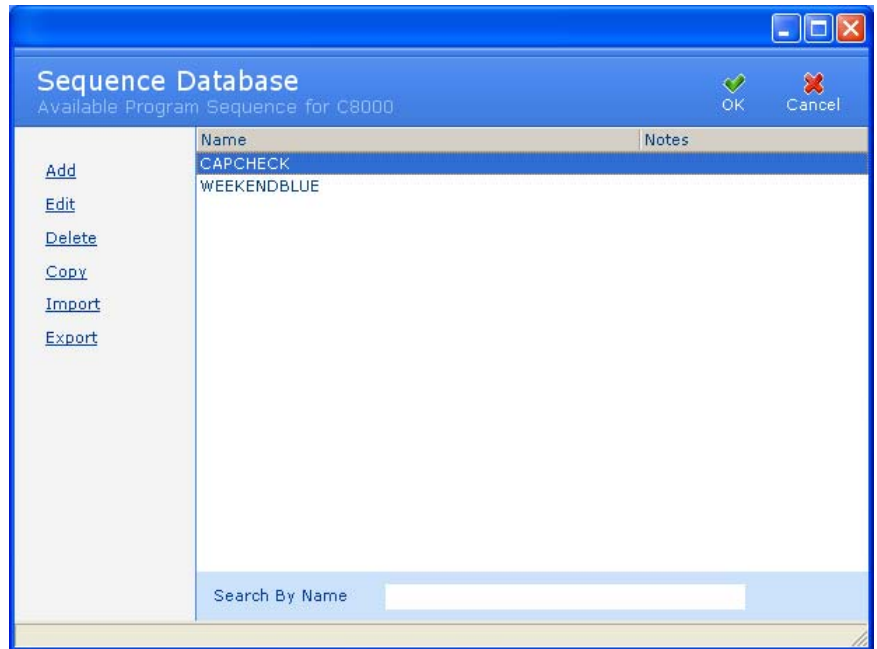
4. Click *From the C8000*.
5. Select the C8000 that contains the program sequence to import.
6. Click **Import** and click **OK**.

---

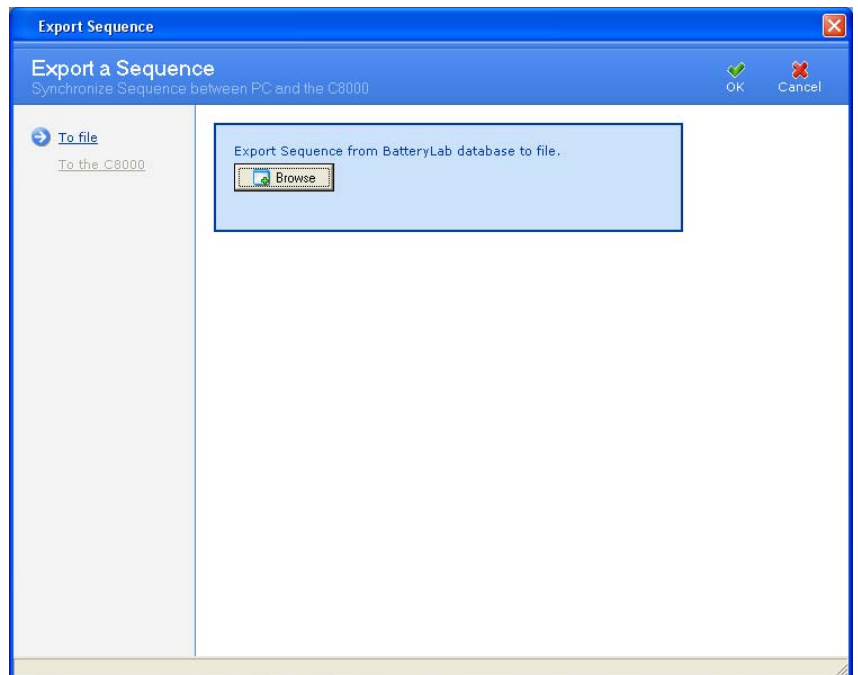
### 3.13.6 Export a Program Sequence

**Note:** Only one sequence program may be exported at a time. To export a program sequence to a file:

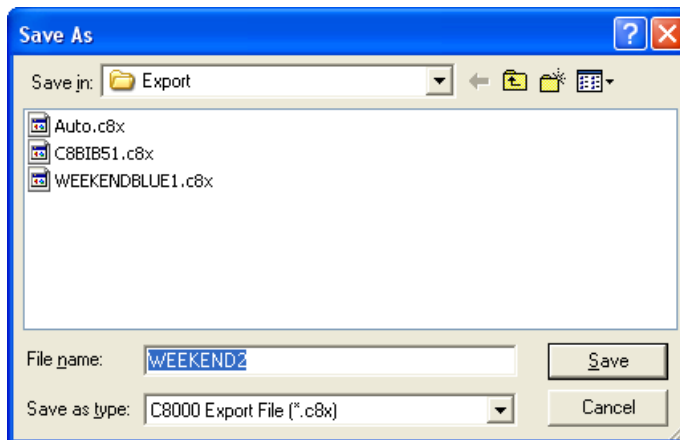
1. From the **Database** menu, click **Sequencer**. The **Sequence Database** window appears.



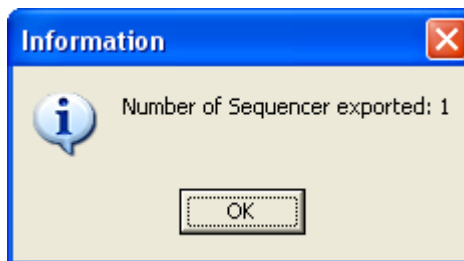
2. Select the program sequence to export. Hold the CTRL key down to select multiple records.
3. Click **Export**. The **Export a Sequence** window appears.



4. Click **Browse**. The **Save As** window appears.

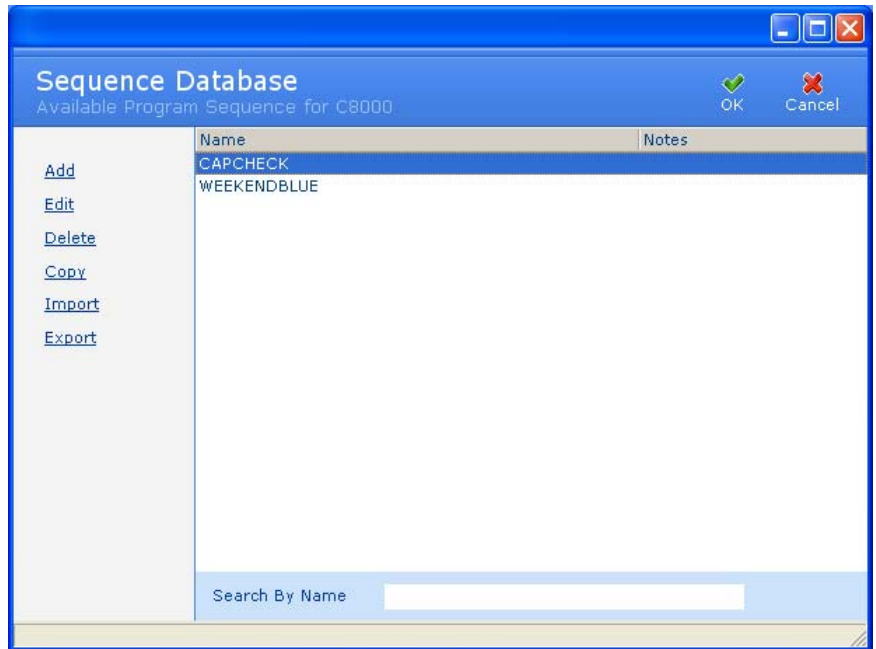


5. Type a name for the export file in the *File name* field.
6. Click **Save**.
7. An **Information** window appears with the number of program sequences exported.

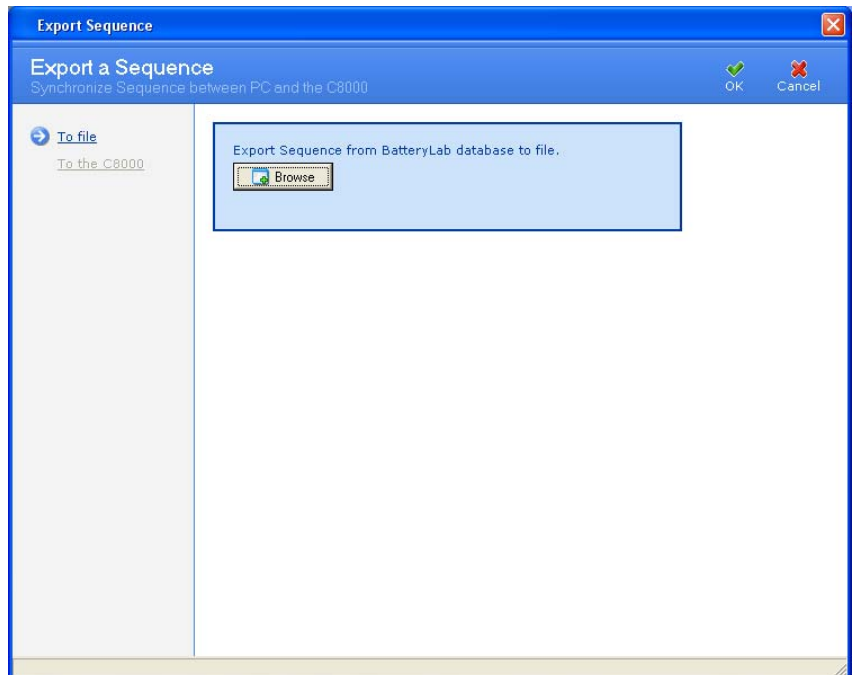


To export a program sequence to the C8000:

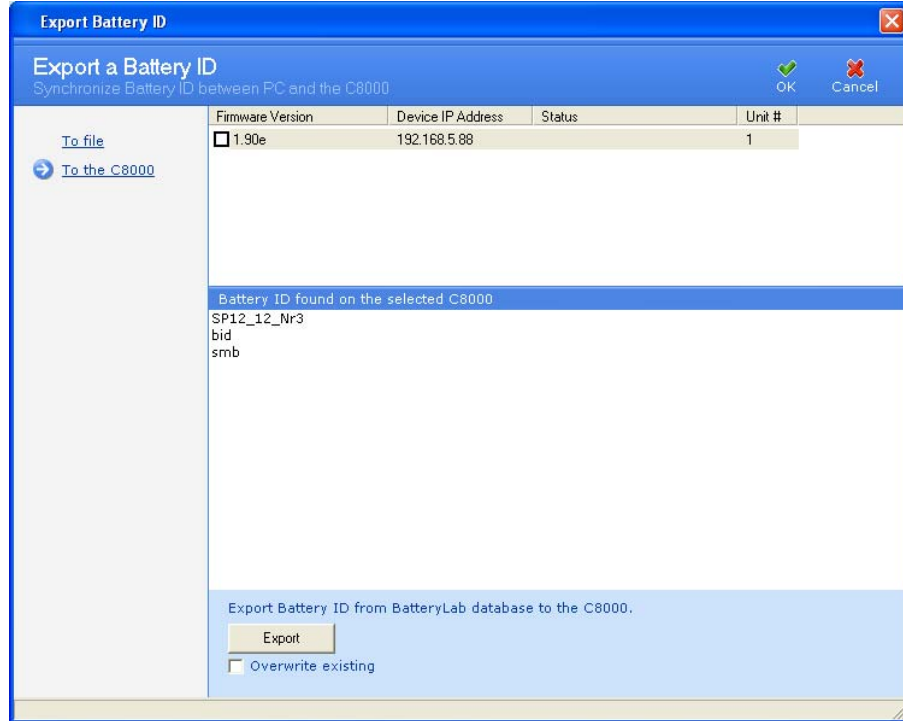
1. From the **Database** menu, click **Sequencer**. The **Sequence Database** window appears.



2. Select the program sequence to export. Hold the CTRL key down to select multiple records.
3. Click **Export**. The **Export a Schedule** window appears.



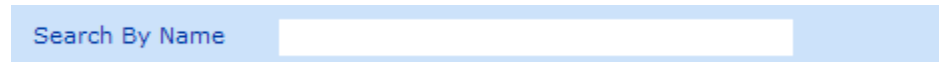
4. Click **To the C8000**. A list of connected C8000s appears.



5. Click **Export**.

### 3.13.7 Search for a Program Sequence

The BatteryLab database may contain many program sequences. To find a program sequence, click the *Search By Name* field to move the cursor to that field.



Next, type the first one or two characters of the program sequence's name to find. As BatteryLab locates the partial name, it will highlight the corresponding sequence in the **Sequence Database** window.

### 3.13.8 Sort Program Sequences

The BatteryLab database may contain many program sequences. To sort the program sequences in ascending order, click the *Name* column in the **Sequence Database** window. Click the column a second time to sort the program sequences in descending order.

---

## 3.14 System Updates

---

### 3.14.1 Firmware Information



#### Caution

**Before updating the firmware on the C8000s, ensure that test results and calibration data have been backed up from the C8000s to the PC.**

From the **Tools** menu you can view the **System Update** window, which shows you:

- The *Device List* displays each connected C8000 with its associated firmware version's IP address and status.
- The System Update file location. The **Browse** button will accept only valid C8000 System Update (\*.c8u) files to enable the **Update** button.

#### 3.14.1.1 Update the Firmware on the C8000s



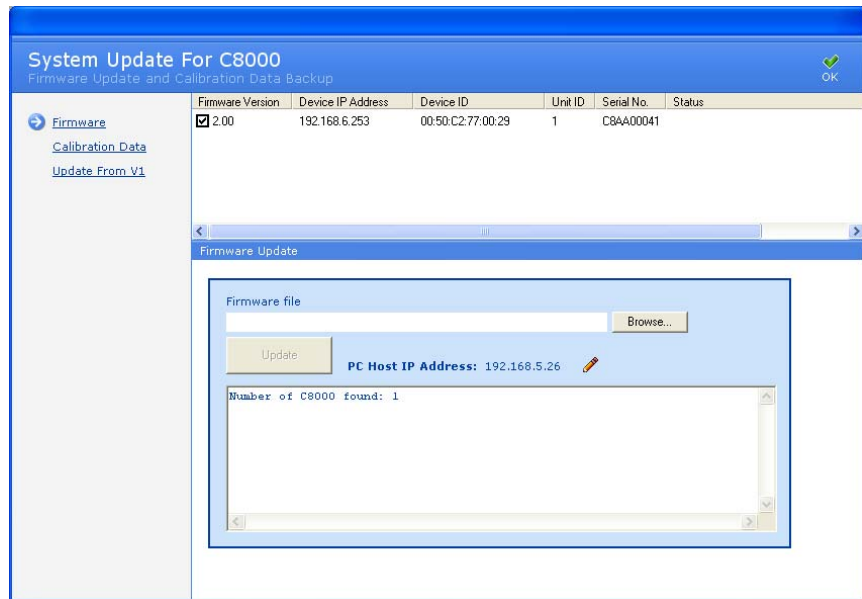
#### Caution

**Do not interrupt the update process once it has started. The C8000s could be rendered non-operational if the update process does not complete properly.**

To update the firmware on C8000s connected to the network:

1. From the **Tools** menu, click **System Update**. The **System Update** window appears.





Ensure that all connected C8000s are powered on and are properly configured.

2. Click **Firmware**.
3. Select the check box for each C8000 to update.

**Note:** Only a single C8000 can be updated at any given time.

4. Click **Browse** to find the folder containing the new firmware file on your hard drive. (The firmware files have a **.c8u** extension; you can obtain these from Cadex Electronics Inc.).
5. Select the new firmware file.
6. Click **Update** to send the firmware to the connected C8000s.

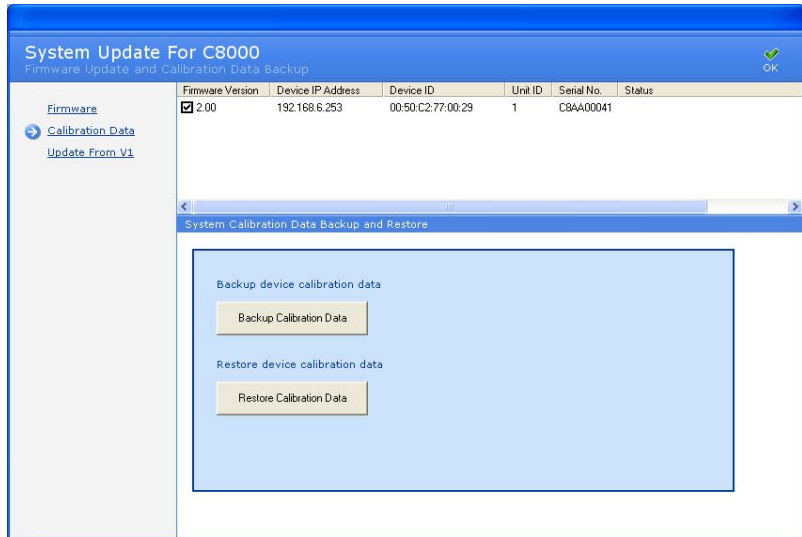
Battery Lab must remain open while the C8000s are updated, which takes several minutes. When the update is complete, the *Status* will show *Update Completed*.

The **Update** button is enabled only if the selected file (with a **.c8u** extension) is valid.

### 3.14.1.2 Update the Calibration Data

To update the calibration data on the C8000s:

1. From the **Tools** menu, click **System Update**. The **System Update** window appears.
2. Click **Calibration Data**.



3. To back up the calibration data, click **Backup Calibration Data**.
4. To restore calibration data, click **Restore Calibration Data**.

## 3.15 Troubleshooting

### 3.15.1.1 Communication Issues

Frequent disconnections between the PC and a C8000 can be caused by a duplicated TCP/IP address on the network.

1. From the **C8000** menu, select **Data Monitor** and verify that the C8000 and BatteryLab are communicating. If nothing is displayed, they are not communicating. You can copy and paste the information in the **Data Monitor** to an e-mail if you need to share the information with your network administrator.
2. Ensure that the C8000 is properly connected to the network. At the back of the C8000, the Ethernet port should have a solid light and a blinking light. The solid light indicates that the unit is connected to the network and the blinking light indicates that data is being transferred over the network. (The LED is beside the Ethernet port on the back of the C8000).
3. Your network administrator can also ping (see Ping the Network to Check for Available IP Address) the C8000 to make sure it is communicating properly with the network.
4. If the C8000 is disconnecting and connecting frequently, resolve IP Address conflicts with other devices (duplicated IP address) on the network.

### 3.15.1.2 Frozen Keyboard and LCD Display

The keyboard and display on the C8000 may stop functioning if the Ethernet cable is disconnected and reconnected from the PC, the local network hub, or the C8000 while the C8000 is on. To solve this problem, recycle the power on the C8000.

### 3.15.1.3 Check IP Addresses

See *Add IP Addresses for C8000s on Your PC*.

Check for duplication in the **IP Address Manager** window.

Review the topics under **TCP/IP Settings**.

### 3.15.1.4 DAO Error

If a DAO (Data Access Object) error message appears, it results from one of two cases:

- A corrupt BatteryLab database; or
- Folder permissions for \batlab have been reset to their defaults and are preventing users from accessing the database.

### 3.15.1.5 Corrupt Database

If the BatteryLab database is corrupt, you can restore the database from a recent backup of the files from the **batlab** folder.

For information about restoring files backed up using “**Windows Backup**” in Windows XP, use **Start > Help** and use the **Help Index** to find topics under **restoring backed up data**.

If your System Administrator cannot solve the problem, contact Cadex Customer Support for help in repairing the database.

### 3.15.1.6 Folder Access Permissions

BatteryLab Setup sets the required folder permissions during installation. However, if the computers in your network have Rights Management controlled from a central server, then you may notice folder permissions for the \Batlab folder being reset, causing BatteryLab to report a DAO error.

If a centralized server manages folder permissions on your network, then you have one of two options to resolve Folder Access Permission issues:

1. Uninstall BatteryLab from the default install location (C:\Program Files\batlab) and re-install to C:\batlab. Make a copy of the C:\Program Files\batlab\db folder prior to un-installation so that the DB folder can be restored from the copy after re-installation.
2. Make a request of your Systems Administrator to configure the central server's rights management policies to allow default folder permissions on the batlab folder (C:\Program Files\batlab) on your computer as described in [Set Access Permissions in Windows XP](#).

### 3.15.1.7 Set Access Permissions in Windows XP

To set access permissions in Windows XP:

1. Log-on as Administrator.
2. Navigate (using Windows Explorer or My Computer) to the \Batlab folder.
3. Right-click the **Db** folder and choose **Properties**.
4. Click the **Security** tab.
5. Choose the User Group and select the *Full Control* check box.

6. Clear the *Allow inheritable permissions from parent to propagate this object* check box.
7. Click **Copy**.
8. Click **OK**.

If the **Security** tab is not displayed, use the following method:

1. Double-click **My Documents** on the desktop.
2. From the *Tools* menu, choose **Folder Options...**
3. Choose the **View** page.
4. Clear the *Use simple file sharing* (recommended) option and click **OK**.
5. Type *C:\Program Files\Batlab* for My Documents address and press **Enter**.
6. Right-click the **Db** folder and choose **Properties**.
7. Click the **Security** tab.
8. Choose users in the group or user names list.
9. Select the *Full Control Allow* check box.
10. Click **Advanced**.
11. Clear the *Inherit from parent...* check box and choose **Copy**.
12. Click **OK** to close the dialog box.
13. Double-click **My Documents** on the desktop.
14. From the *Tools* menu, choose **Folder Options...**
15. Choose the **View** page.
16. Select the *Use simple file sharing* (recommended) option and click **OK**.

#### **3.15.1.8 Error Writing to the Log File**

While using BatteryLab, an error may occur when the software writes to the log file. In this case, the permissions to the *\Batlab\Temp* folder have been reset. You need to set the appropriate permissions to this folder – follow the same steps on the Temp folder as was done in [Set Access Permissions in Windows XP](#).

## 4 C-Code Parameters

The following table lists the parameters for c-codes. Note that not all parameters are used by all chemistries.

Field	Description	Compatible Chemistry	Limits		Units	Additional requirements	Typical Range(s)	SM-BUS Imported Registers	Notes:
			Min.	Max.					
Chemistry	Battery Chemistry	All	N/A	N/A	N/A	----	N/A	0x22	Any change to this field to affect all other fields
Number of Cells	Cells	All	1	NiMH = 30	N/A	----	N/A	No	Maximum Value is Chemistry dependent (Any change to this field to affect all other fields)
				NiCD = 30					
				SLA = 18					
				Li = 10					
				Primary = 30					
				LiPh = 10					
Rating	Capacity rating of the battery stated in mAh	All	0.050	1000	Ah	----	None	0x18	Any change to this field to affect all other fields
Minimal Safe Operating	The minimal Voltage allowed for the battery.	NiMH & NiCD	0.320 * cells	<MaxVoltage	V	----	----	No	----
		Li, SLA	1.000 * cells				----		

Field	Description	Compatible Chemistry	Limits		Units	Additional requirements	Typical Range(s)	SM-BUS Imported Registers	Notes:
			Min.	Max.					
Voltage		LiPh	0.750 * cells				----		
		Primary	0.320 * cells				----		
Maximum Safe Operating Voltage	The maximum Voltage allowed for the battery	NiMH & NiCD		1.800 * cells	V	45.000	----	No	Primary Chemistry has two Maximum voltages. The selection depends on the Nominal voltage selected by the user.
		SLA		2.800 * cells		48.048			
		Li		4.500 * cells					
		LiPh	----	4.200 * cells					
		Primary (1.2v nominal)		1.800 * cells					
		Primary (3v nominal)		4.500 * cells					
Maximum Charge	Maximum safe operating charge current	NiMH & NiCD	0.030	10.000	A	----	----	No	----
		SLA, Li, LiPh	0.055						
Maximum Discharge	Maximum safe operating discharge current	All	Rating<=100ah 0.030	10.000	A	----	----	No	----
			Rating>100ah 0.200						
Maximum Temperature	Maximum safe operating temperature	All	----	105	°C	----	----	No	----
Charge Current	Charge rate	NiMH & NiCD	Rating<=100ah 0.030	= Maximum Charge	A	----	0.01~2C	0x14	

Field	Description	Compatible Chemistry	Limits		Units	Additional requirements	Typical Range(s)	SM-BUS Imported Registers	Notes:
			Min.	Max.					
			Rating>100ah 0.200						
		SLA, Li, LiPh	Rating<=100ah 0.055						
			Rating>100ah 0.200						
Discharge Current	Discharge rate	All	Rating<=100ah 0.055	= Maximum Discharge	A	----	0.01~2C	0x14	----
			Rating>100ah 0.200						
Low temperature	Low temperature limit	All	-30	80	°C	< Maximum Temperature	0 ~ 10	No	Zero value is valid
High temperature	High temperature limit	All	-10	<(Maximum Temperature - 5)	°C	----	40 ~ 50	No	Zero value is valid
End of discharge	End of discharge Voltage	All	> Minimal Voltage	(NiCD, NiMH) < Maximum Voltage	V	----	(NiCD, NiMH) 0.76~1.12V*cell	No	----
				(SLA) 1.36~1.95V*cell					
				(Li) 2.30~ 3.20V*cell					
				(LiPh) 1.90~2.35V*cell					



Field	Description	Compatible Chemistry	Limits		Units	Additional requirements	Typical Range(s)	SM-BUS Imported Registers	Notes:
			Min.	Max.					
Rapid Charge Voltage	Voltage requirement for full charge current	All	> Minimal Voltage	(NiCD, NiMH) < Maximum Voltage (SLA, Li, LiPh) < Charge Voltage	V	----	----	No	----
Delta T	Delta-T - °C per minute	All	1	10	°C/Min	----	N/A	No	----
Charge timeout	Maximum duration of a charge before Failure	All	0	300	C-Minute	----	----	No	Zero value is valid and indicates Parameter is "OFF"
Discharge timeout	Maximum duration of a Discharge before Failure	All	0	300	C-Minute	----	----	No	Zero value is valid and indicates Parameter is "OFF"
Target capacity	Minimal Capacity Requirement of the battery type	All	1	253	%	----	70 ~ 90	No	
Automatic ohmtest	Perform automatic ohmtest	All	N/A	N/A	----	----	----	No	(1=yes, 0=no)
Milli-ohms	The pass/fail point of the battery resistance	All	0	1000	m-ohm	----	----	No	----

Field	Description	Compatible Chemistry	Limits		Units	Additional requirements	Typical Range(s)	SM-BUS Imported Registers	Notes:
			Min.	Max.					
Trickle charge rate	----	NiMH & NiCD	Rating<=100ah 0.055	<= Charge Current	A	----	0.01~0.05C	No	----
			Rating>100ah 0.200						
Trickle discharge rate	----	NiMH & NiCD	Rating<=100ah 0.055	<= Discharge Current	A	----	0.1~0.12C	No	Discharge Rate during a Recondition Action for NiXX
			Rating>100ah 0.200						
End of recondition	----	NiMH & NiCD	> Minimal Voltage	< End of discharge	V	----	0.40~0.80 V/cell	No	----
Reverse load weight	----	NiMH & NiCD	0	20	%	----	5% – 12%	No	Zero value is valid and indicates Direct Current
Negative slope (delta-V)	Fall of the voltage for charge completion	NiMH & NiCD	0.001	0.200 x cells	V	----	1mV ~ (Cell Count x64mV)	No	Negative Slope is used to determine full charge condition for NiCD or NiMH batteries. Full charge is determined by measuring the voltage drop that occurs once the battery reaches full-charge (the fast-charge is

Field	Description	Compatible Chemistry	Limits		Units	Additional requirements	Typical Range(s)	SM-BUS Imported Registers	Notes:
			Min.	Max.					
									terminated when the voltage drop reaches the pre-set rate).
Negative slope delay time	Duration before a negative slope is detected.	NiMH & NiCD	0	20	C-Minute	----	----	No	Zero value is valid and indicates Parameter is "OFF"
Standby voltage	----	SLA, Li, LiPh	> End of discharge	<= Minimal Voltage	V	----	(SLA) 2.15~2.45V/cell	No	----
							(Li) 3.90~4.35V/cell		
							(LiPh) 3.20~3.65V/cell		
Maximum charge voltage	The charging voltage for constant voltage batteries	SLA, Li, LiPh	> Minimal Voltage	< Maximum Voltage	V	Maximum charge voltage of 45V	(SLA) 2.15~2.60V/cell	0x15	----
							(Li) 3.90~4.35V/cell		
							(LiPh) 3.40~3.85V/cell		
Charge termination point	Termination Point for Constant Voltage Batteries	SLA, Li, LiPh	Rating<=100ah 0.055	<Charge Current by 25mA	A	----	0.01~0.10C	No	----
			Rating>100ah 0.200						

**Code Options**

Field	Description	Compatible Chemistry	Limits		Units	Additional requirements	Typical Range(s)	SM-BUS Imported Registers	Notes:
			Min.	Max.					
	Smart Battery		When active the C-code is enabled for SM-BUS batteries and the following parameters become available: 1) "Fully Charged" 2) Terminate Charge Alarm 3) Overcharge Alarm 4) Fully Discharged Alarm 5) Terminate Discharge Any of the above options can be set to one the following conditions; 1) Finished –will terminate the program successfully on flag 2) Fail –will terminate the program with a failure on flag 3) Ignore – will ignore the flag. 6) Over temperature Alarm options; 1) Ignore – will ignore the flag. 2) Retry x (1~10) – will wait for multiple flag conditions before terminating with a failure. (Over temperature Only).						
	Use External Load Maximum Discharge Rate		Alters the Maximum Discharge Rate field to use the device's (specified in the program) Maximum current rate. (Defaults to C8000 maximum of 10A).						

# 5 Status Messages

The following table lists status messages by status code.

The second table lists status messages by detailed message. That table describes the reason for each type of message and possible solutions.

## 5.1 Status Messages Listed by Code

Code	Global Message	Detailed Message
0	NO BATTERY	NO BATTERY IS CONNECTED TO THE CHANNEL TERMINAL
1	RESERVED	RESERVED
2	CHARGE	A CHARGE CURRENT IS BEING APPLIED
3	TRKL CHRГ	A CHARGE CURRENT IS BEING APPLIED AT A RATE APPROXIMATELY EQUAL TO THE RATE OF SELF-CHARGE FOR NiXX, LEAD ACID BATTERIES, OR AT A RATE PROGRAMMED IN THE C-CODE FOR ALL BATTERY TYPES IF IN A LOW VOLTAGE CONDITION
4	RECONDITIONING	FOR NiXX BATTERIES ONLY. DISCHARGING BATTERY TO THE RECONDITION VOLTAGE PROGRAMMED IN THE C-CODE
5	STARTUP	A BATTERY IS CONNECTED TO THE CHANNEL AND AWAITING SERVICING
6	AUX I/O	NO CURRENT IS ACTIVELY BEING APPLIED TO THE BATTERY THROUGH THE BATTERY PORTS. ONLY THE AUXILLIARY PORTS ARE ACTIVE
7	DISCHARGE	A DISCHARGE CURRENT IS BEING APPLIED TO THE CONNECTED BATTERY
8	RESERVED	RESERVED
9	NO ACTION	NO BATTERY SERVICING IS OCCURRING. PROGRAM IS WAITING FOR A TEST CONDITION TO BE MET. DEFAULT ACTION IS TO END STEP
10	RESERVED	RESERVED
11	RESERVED	RESERVED

12	COLD WAIT	THE BATTERY TEMPERATURE BEING REPORTED VIA THE CHANNEL THERMISTOR IS BELOW THE "LOW TEMPERATURE LIMIT" (C-CODE) AND WAITING FOR THE TEMPERATURE TO RISE 5°C ABOVE, BEFORE CONTINUING SERVICING THE BATTERY.
13	HOT WAIT	THE BATTERY TEMPERATURE BEING REPORTED VIA THE CHANNEL THERMISTOR IS ABOVE THE "HIGH TEMPERATURE LIMIT" (C-CODE) AND WAITING FOR THE TEMPERATURE TO FALL 5°C BELOW, BEFORE CONTINUING SERVICING THE BATTERY
14	OVERHEAT	THE BATTERY TEMPERATURE BEING REPORTED VIA THE CHANNEL THERMISTOR IS ABOVE THE "MAX TEMPERATURE LIMIT" (C-CODE. PROGRAM HAS TERMINATED
15	FINISHED	BATTERY SERVICE WAS COMPLETED SUCCESSFULLY AND CHANNEL HAS EITHER ENTERED STANDBY OR HAS TERMIAATED THE SERVICE, AS DEFINED BY THE PROGRAM (AS DEFINED BY STEP "0" IN A PROGRAM)
16	PROGRAM FAIL	BATTERY SERVICE HAS FAILED
17	REMOVED	THE BATTERY HAS BEEN DISCONNECTED FROM THE BATTERY TERMINALS
18	RESERVED	RESERVED
19	RESTING	NO CURRENT IS ACTIVELY BEING APPLIED TO THE BATTERY THROUGH THE BATTERY PORTS
20	INSERTED	A BATTERY IS CONNECTED TO THE CHANNEL AND THE CHANNEL SCREEN IS ACTIVE AWAITING BATTERY PARAMETERS (C-Code) AND PROGRAM TO BEGIN SERVICING
21	PAUSE	THE BATTERY SERVICE HAS BEEN SUSPENDED AS DEFINED BY THE PROGRAM
22	RESERVED	RESERVED
23	RESERVED	RESERVED
25	RESUME	CYCLE RESUMED
26	SUSPENDED	THE BATTERY SERVICING HAS BEEN PLACED IN "SUSPEND" BY THE USER
27	OHMTEST	A DC RESISTANCE TEST IS BEING CONDUCTED
28	IMPEDANCE	AN AC RESISTANCE TEST IS BEING CONDUCTED
29	LCU ARMED	LOAD CAPTURE DEVICE IS ARMED
30	CYCLE DONE	THE CURRENT SERVICE CYCLE HAS BEEN COMPLETED
31	DISCHARGE DONE	THE CURRENT DISCHARGE SVCICICE HAS BEEN COMPLETED
32	RESUMED	THE BATTERY SERVICE HAS RESUMED AS DEFINED BY THE PROGRAM AFTER BEING EITHER PLACED IN "SUSPEND" BY THE USER OR PLACED IN "PAUSE" BY THE PROGRAM
33	USER TIMEOUT	THE SERVICE HAS TIMED-OUT AS DEFINED IN THE C-CODE
34	BATTERY LAB	SERVICE IS WAITING FOR COMMUNICATION WITH BATTERYLAB SOFTWARE

36	LCU READY	LOAD CAPTURE UNIT IS CONNECTED AND FUNCTIONAL
37	RESERVED	RESERVED
50	RESERVED	RESERVED
51	RESERVED	RESERVED
107	RESERVED	RESERVED
108	RESERVED	RESERVED
109	RESERVED	RESERVED
110	RESERVED	RESERVED
111	RESERVED	RESERVED
112	CELL MISMATCH	CELLS ARE REACHING FULL CHARGE AT DIFFERENT TIMES SO THE NEGATIVE SLOPE IS NOT WELL DEFINED. THE PROGRAM PROCEEDS TO THE NEXT CYCLE
113	PLATEAU TIMEOUT	VOLTAGE LEVEL HAS REMAINED CONSTANT FOR AN EXTENDED TIME AND END-OF-CHARGE CONDITIONS CANNOT BE MET
115	RESERVED	RESERVED
116	TARGET NOT MET	THE "TARGET CAPACITY" VALUE IN THE C-CODE HAS NOT BEEN MET
118	RESERVED	RESERVED
119	WEAK BATTERY	BATTERY VOLTAGE FALLS BELOW THE END-OF-DISCHARGE VOLTAGE (AS DEFINED IN THE C-CODE) DURING AN OHMTEST
120	OVER VOLTAGE	THE BATTERY VOLTAGE IS HIGHER THAN THE "MAX. SAFE OPERATING VOLTAGE" AS DEFINED IN THE C-CODE
121	REVERSED	BATTERY REVERSED
122	SHORTED	THE BATTERY VOLTAGE IS EITHER EXTREMELY LOW OR THE TERMINALS HAVE BEEN SHORTED
123	L.V. TIMEOUT	BATTERY VOLTAGE IS BELOW 800mV/cell FOR 1c-minute (CHARGE CONDITION ONLY)
124	L.V. TIMEOUT	BATTERY VOLTAGE IS BELOW MINIMAL VOLTAGE LEVEL FOR 10C-MINUTE. (CHARGE CONDITION ONLY). NiXX – 1144Mv, LA – 1990MV. LI-2000mV
125	NO SLOPE	NiXX ONLY. NO NEGATIVE SLOPE DETECTED
126	LOW VOLTAGE	ONE OR MORE CELLS WITHIN THE BATTERY PACK ARE LOWER THAN THE "MIN. SAFE OPERATING VOLTAGE" (DIVIDED BY THE NUMBER OF CELLS) AS DEFINED IN THE C-CODE
127	LOW VOLTAGE	BATTERY VOLTAGE IS BELOW "MIN. SAFE OPERATING VOLTAGE" AS DEFINED IN THE C-CODE
128	SOFT	NiXX ONLY. BATTERY VOLTAGE HAS REACHED THE "MIN. SAFE OPERATING VOLTAGE" AS DEFINED IN THE C-CODE
129	RESERVED	RESERVED
130	CURRENT RISE	CURRENT IS INCREASING DURING A CONSTANT VOLTAGE
131	IMPED. SKIPPED	AC RESISTANCE TEST IS A STEP IN A PROGRAM AND HAS BEEN SKIPPED, AS AC RESISTANCE TESTING CAN ONLY BE PERFORMED ON CHANNEL 1

135	RESERVED	RESERVED
136	RESERVED	RESERVED
137	IMPED. SKIPPED	AC IMPEDANCE TEST CAN BE PERFORMED ON CHANNEL 1 ONLY
139	Out-of-Range	AC IMPEDANCE MEASUREMENT VALUE IS OUT OF MEASURABLE RANGE.
142	DCHG TIMEOUT	THE MAXIMUM DISCHARGE TIME HAS BEEN REACHED AS DEFINED IN THE C-CODE. "DISCHARGE TIMEOUT"
144	CHRG TIMEOUT	THE MAXIMUM CHARGE TIME HAS BEEN REACHED AS DEFINED IN THE C-CODE. "CHARGE TIMEOUT"
146	RECOND TIMEOUT	THE MAXIMUM DISCHARGE TIME HAS BEEN REACHED AS DEFINED IN THE C-CODE. "DISCHARGE TIMEOUT" (NIXX ONLY)
150	BAD THERMISTOR	UNABLE TO READ THE THERMISTOR ATTACHED TO THE POWER PORT CABLE
152	TEMP RISE	THE TEMPERATURE ROSE AT A RATE GREATER THAN 2°C WITHIN 30 SECONDS
154	RESERVED	RESERVED
156	RESERVED	RESERVED
158	RESERVED	RESERVED
159	RESERVED	RESERVED
160	FUSE/DRIVER	NO CURRENT OUTPUT HAS BEEN DETECTED FOR 1 MINUTE
161	NO_PARALLEL	THE STEP "PARALLEL DISCHARGE" IS BEING ATTEMPTED TO BE RUN AND NO DUAL PORT CABLE IS ATTACHED TO THE UNIT
162	DCHG MA LOW	DISCHARGE CURRENT TARGET CANNOT BE MET, BUT A LOW RATE OF DISCHARGE WAS DETECTED
164	CHRG MA LOW	CHARGE CURRENT TARGET CANNOT BE MET, BUT A LOW RATE OF CHARGE HAS BEEN DETECTED
170	CAL. FAILED	AN ERROR WAS DETECTED WITH THE CALIBARATION INFORMATION
175	UNDERCHARGED	BATTERY IS UNDERCHARGED
176	OVERCHARGED	BATTERY IS OVERCHARGED
177	UNDERCHARGED	UNDERCHARGED
178	OVERCHARGED	OVERCHARGED
188	ABORTED	SERVICE INTERRUPTED
190	AIN ERROR	ANALOG PORT VOLTAGE READING OUT OF RANGE
192	RESERVED	RESERVED
195	CAPACITY GOOD	CAPACITY GOOD
207	SYSTEM TEMP	EXTERNAL SYSTEM TEMPERATURE IS ABOVE MAXIMUM SYSTEM TEMPERATURE
208	RESERVED	RESERVED
209	CURRENT > MAX	REQUESTED TARGET CURRENT LEVEL IS GREATER THAN THE SYSTEM MAXIMUM OUTPUT OF 10A PER CHANNEL



210	BAD WAVEFORM	THE REQUESTED WAVEFORM EXCEEDS EITHER THE SYSTEM MAXIMUM LIMITS OR IS GREATER THAN THE BATTERY LIMIT AS DEFINED IN THE C-CODE
211	WATTS > MAX	THE REQUESTED POWER (WATTAGE) IS GREATER THAN THE SYSTEM MAXIMUM OF 100W (CHARGE) / 80W (DISCHARGE)
212	WAVEFORM FAULT	ONLY ONE SUB-MILLISECOND WAVEFORM ALLOWED PER CHANNEL PAIR
215	LOW_OFFSET_ERROR	THE AUTOMATED CALIBRATION FOR THE LOAD CAPTURE UNIT IS OUT OF RANGE
218	LCU_CHANNEL_1_ONLY	LOAD CAPTURE DEVICE IS SUPPORTED ON CHANNEL 1 ONLY
219	LCU_CAPTURING	LOAD CAPTURE UNIT IS CAPTURING DATA
220	LOOP CNT TEST	LOOP COUNTER TEST
221	VOLTAGE TEST	VOLTAGE TEST
222	CURRENT TEST	CURRENT TEST
223	TEMP. TEST	TEMPERATURE TEST
224	DELTA-T TEST	DELTA-TEMPERATURE TEST TEMPERATURE TEST
225	IMPED. TEST	IMPEDANCE/RESISTANCE TEST
226	ERROR CODE TEST	ERROR CODE TEST
227	VARIABLE TEST	VARIABLE TEST
228	VARIABLE DIFF	VARIABLE DIFFERENCE TEST
229	AUX. PORT TEST	AUX. PORT TEST
230	AUX. DIFF TEST	AUX. DIFFERENCE TEST
231	LCU_REVERSED	LOAD CAPTURE DEVICE IS DETECTING A REVERSE CURRENT FLOW
232	LCU_CALIBRATING	LOAD CAPTURE UNIT IS BEING CALIBRATED
233	TEMPERATURE OF RANGE	TEMPERATURE IS OUT-OF-MEASURABLE RANGE
234	PARALLEL	CHANNEL IS IN PARALLEL MODE
236	NO PRIMARY CHG	NO CHARGE ALLOWED ON PRIMARY CELLS
255	OFFLINE	DSP CONTROLLER IS "OFFLINE"

## 5.2 Status Messages Listed by Detailed Message

Detailed Message	Code	Reason	Solution
BAD FUSE OR DRIVER	160	The tester is not able to supply current to the battery through its current drivers. Very low values of current (about 0 mA) are displayed on the tester and after 10 seconds processing stops.	Clean the battery and adapter contacts. Verify that mAh rating of the battery matches the C-code. Lower the Charge rate and the Trickle Charge rate in the C-code. The battery may be faulty. Try a different battery in the same channel. Check the circuit breakers on the tester. If all fails, contact Cadex for service.
BATTERY INSERTED	20	The C8000 detects a battery in an adapter.	If message persists, press ESC.
BATTERY OVER TEMP	14	Battery has overheated during charge. Channel goes to Resting 00:00 (code 19) until the battery cools.	Reduce the Charge rate in the C-code.
BATTERY REMOVED	17	Battery was removed when the program completed.	This message appears briefly when the battery is removed. If message persists, press ESC.
SUSPEND	26	User suspended the test.	Resume or wait for the condition that caused the "suspend" mode to be resolved. If this message persists, abort the test. If this condition cannot be resolved, contact Cadex for support.
BATTERY REVERSED	121	Reverse voltage detected on insertion.	Battery may be connected backwards in the adapter. Ensure that battery leads are firmly connected to the battery.
BATTERY SHORTED	122	Battery voltage is lower than (the voltage remains low).	Ensure battery leads are firmly connected to the battery. Battery may be shorted.
BATTERY TOO COLD	12	Battery temperature is too cold when inserted. The battery is trickle charged until temperature rises above minimum. (Only for NiCad / NiMH).	Allow the battery to warm up.
BATTERY TOO HOT	13	Battery temperature is too hot when inserted. The battery automatically starts processing when temperature drops 5°C below maximum value.	Allow the battery to cool or use the tester in a cooler room.

OFFLINE	255	A system operation, such as a firmware upgrade, is being performed.	
CELL MISMATCH	112	Cells are reaching full charge at different times so the negative slope is not well defined. The program proceeds to the next cycle.	Wait until processing is complete. Battery is old or has been in storage. Operating time may be reduced. Either monitor battery use or discard the battery.
CHARGE CURRENT LOW	164	Tester cannot provide the requested charge current	See BAD FUSES OR DRIVER, Code 160.
CHARGE TIMEOUT	144	Charge time has exceeded the expected value for the battery.	Tester may not have detected the end of charge conditions.
CHARGING	2	Battery is being charged normally.	
RESUMED	32	Power resumed or the battery is re-inserted into the adapter.	
DISCHARGE CURRENT LOW	162	The tester cannot discharge the battery.	See BAD FUSES OR DRIVER, Code 160.
DISCHARGE TIMEOUT	142	Battery capacity has exceeded 250% of the rated capacity.	
DISCHARGING	7	Battery is being discharged normally.	Program will continue when cycle has completed.
HOT BATTERY ON TRICKLE CHARGE	159	Battery temperature has exceeded its maximum setting after service has ended and battery was on trickle charge. The trickle charge stops.	Lower the room temperature. Verify that the C-Code is correct for the battery. Battery may be in poor condition.
INSERT THE BATTERY	8	Insert battery in the battery adapter.	
LOW VOLTAGE TIMEOUT1	123	Battery voltage remains low after approximately one minute into the charge cycle.	See BATTERY SHORTED, Code 122.
LOW VOLTAGE TIMEOUT2	124	Battery voltage remains low after approximately ten minutes into the charge cycle.	See BATTERY SHORTED, Code 122.
NO BATTERY	10	No battery is inserted, or the inserted battery is not detected.	Check and clean all contacts.
OFFLINE	255		
OVER VOLTAGE	120	Battery voltage is too high.	Discard the battery.
PAUSE	21	PROGRAM IS PAUSED (CUSTOM PROGRAM FUNCTION ONLY).	
PLATEAU TIMEOUT	113	Battery was fully charged before full-charge conditions were met. For SLA and Li batteries only.	The end-of-charge setting in the C-code may have to be increased. Battery may be old and operating time less than manufacturer's specifications.
PROCESS COMPLETE	15	Current battery-service program is complete.	
PROGRAM HAS FAILED	16	The program has produced an error. The Next statement is not processed. The program has been terminated.	See the detailed display for the exact nature of battery failure.

READY	5	A battery has been inserted and is ready to be serviced. (Also, indicated as Startup).	
RECONDITIONING	4	Battery is being reconditioned.	The program will proceed to the next step when recondition has completed.
RESTING	19	Channel is in a rest period, as specified in the program.	The program will proceed to the next step when resting period is complete.
ABORTED	188	An abort command has been issued. Program terminated.	The user issued an abort command.
SYSTEM TEMP. HIGH: COOLING	207	Service on all channels is temporarily suspended due to high temperature inside the tester.	Service will resume in a few minutes, after the board has cooled down. If it reoccurs continuously, move the tester to a cooler room.
TARGET CAPACITY NOT MET after service	116	Final capacity of the battery is below the target capacity. Attempts to improve battery capacity did not succeed in bringing capacity above target.	Battery is old and has less operating time than manufacturer's specification.
TRICKLE CHARGE	3	The program is running a trickle charge. The reconditioning process is complete and the battery is being recharged.	
SOFT	128	Battery voltage is too high. Processing has ended.	Battery may be a high capacity type battery. Check that correct contacts are used. Battery may be in poor condition.
USER PROGRAMMED TIMEOUT	33	The time programmed in a custom program setup has completed.	The program goes to the next step.

## 6 Glossary of Terms

### **Amp**

Abbreviation for ampere.

### **Amperage**

The strength of a current of electricity expressed in amperes.

### **Ampere**

The current produced by one volt across a resistance of one ohm.

### **AWG**

American Wire Gauge (US wire size standard).

### **Backup**

To copy computer files to removable media (such as a writable CD, writable DVD or magnetic tape) files containing data that was current at the time of backup. The latest backup data can be restored to a hard disk in the event that files on the hard disk have become damaged.

### **Battery**

An electrochemical device comprising two or more galvanic (voltaic) cells connected to one another, usually in series.

### **Battery Cycle**

A charge followed by a discharge (or a discharge followed by a charge). A cycle is considered to have occurred even if the battery has only been partially charged and discharged.

**Boot**

Start or re-start a computer by reloading its operating system into random access memory (RAM). Any data that was stored in RAM is lost when a computer is re-booted.

**Byte**

One alphanumeric character or symbol, comprising eight data bits with or without a stop bit and with or without a parity bit.

**Capacity**

The amount of energy (in mAh) that a fully charged battery is capable of holding.

**C-Code**

Configuration Code, battery parameters that are stored in Cadex Battery Testers, and tell the C8000 how to service a specific battery type.

**Cells**

Individual units within a battery. Cells are connected in series or parallel with one another in the battery.

**Check Box**

A square box displayed in a program dialog box, that can contain white space, indicating deselected, or a check mark, indicating selected. When you click the box, it toggles between selected and deselected.

**Comm. port**

Communications port (RS-232C serial port) on a computer used for attaching modems or other serial interface peripheral devices. An Intel® compatible PC may have up to 4 COM ports (COM1, COM2, COM3, and COM4).

**Configuration Code**

Battery parameters that are stored in Cadex battery testers, and tell the C8000 how to service a specific battery type.

**C-Rate**

A value (C number) that is used to calculate charge and discharge times. A discharge of 1 C draws a current equal to the rated capacity of the battery. A discharge of 0.5C would take twice as long to fully discharge the battery.

**Cycle**

One charge and discharge sequence, even if the battery is only partially charged or discharged.

**DAO**

A software component, which provides a common interface between an application and one or more data storage devices, such as a database files.

**Default**

Default settings or values are the original settings or values built in by the manufacturer, before any changes made by users.

**Dialog Box**

A graphical user interface window in which a user can enter or select parameters for use by a computer program.

**Dual Port Cable**

Used to parallel discharge.

**EPSU**

Emergency power supply unit.

**Field**

A text box or pull down list (in a dialog box) used for display or entry of parameter settings, etc.

**Firmware**

Software and/or data stored in read only memory (ROM), embedded in a device for the purpose of control of and communication with the device by a computer.

**Folder**

A computer disk directory or sub-directory, used for storing files. A folder is the disk file equivalent of a drawer in a filing cabinet.

**Host**

A computer to which other devices on a network can connect to access services.

**Impedance**

The opposition offered by an electric circuit to the flow of an alternating current of a single frequency. It is a combination of resistance and reactance and is measured in ohms.

**Intrinsically Safe (I/S)**

A battery with built-in safety protection circuitry. I/S batteries are used in volatile environments.

**Leading zeros**

Zeros that precede the first significant digit (1 through 9) in a number.

**LAN**

Local area network.

**LCD**

Liquid Crystal Display. A type of display panel often used on the front panel of electronic devices, such as the C8000 Battery Tester.

**LCU**

Load Capture Unit.

**LED**

Light emitting diode. LEDs are used to display status of a device.

**Li-ion**

Lithium-ion battery chemistry.

**Li-polymer**

Lithium-polymer battery chemistry. This chemistry is treated similarly to Li-ion.

**mA**

Milliampere. One thousandth of an ampere. Also called milliamp.

**mAh**

Milliampere hour. Battery capacity rating. A current of one milliampere for one hour.



**Matrix**

The set of battery parameters for a specific battery model that is stored with a C-Code during the Q-Learn or Learn process. The matrix is used for doing a QuickTest™ on batteries of the same model.

**Memory**

Capacity loss in NiCD and NiMH batteries, caused by an increase in the size of crystals formed within the battery.

**Milliampere Hour**

Battery capacity rating, a current of one milliampere for one hour. Abbreviation mAh.

**mOhm**

Milliohm, a measure of resistance or impedance, one thousandth of an ohm.

**RMA**

Return Material Authorization. A number or form that must be obtained from Cadex to return goods for a warranty claim

**NiCD**

Nickel-cadmium battery chemistry.

**NiMH**

Nickel-metal-hydride battery chemistry.

**OEM**

Original equipment manufacturer.

**Ohm**

The SI unit of electrical resistance, transmitting a current of one ampere when subjected to a potential difference of one Volt.

**Password**

Passwords must be entered precisely as they were set up. Passwords are case sensitive. For example, 'a' will not be recognized as 'A'.

**PC**

IBM compatible personal computer.

## **Ping**

Packet Internet Groper. A software utility used to determine what devices are available and responsive on a network.

## **Radio Button**

A circle displayed in a program dialog box, that can contain white space, indicating deselected, or a black dot, indicating selected. When you click a radio button, it is selected and all the other displayed radio buttons for alternative options are deselected.

## **Recondition**

A deep discharge below 1 volt per cell with a controlled current. Reconditioning applies only to NiCD and NiMH batteries. Reconditioning helps break down large crystals, which develop as a result of memory, to more desirable small sizes. Reconditioning often restores a battery to its full capacity.

## **Required Field**

A data field that must have appropriate data entered in it. Required fields are usually identified by an asterisk (\*) beside the field name.

## **Residual Capacity**

Capacity remaining in a battery when it is connected to a C8000.

## **Resistance**

Also called internal resistance of a battery. Opposition to current flow.

## **RF**

Radio frequency.

## **P/N**

Part Number.

## **Self Discharge**

Battery capacity lost during storage, because of internal leakage between the positive and negative cell plates.

**Serial port**

Serial communications port (RS-232C serial port) on a computer used for attaching modems or other serial interface peripheral devices. An Intel® compatible PC may have up to 4 COM ports (COM1, COM2, COM3, and COM4).

**Smart Battery**

A battery equipped with circuits that can communicate with a charger.

**State of Charge**

The energy content of a battery.

**State of Health**

The condition of a battery, that considers its capacity, resistance, and self-discharge.

**SoC**

State of Charge.

**SoH**

State of Health

**SLA**

Sealed lead acid battery chemistry.

**Target Capacity**

The capacity level (as a percentage of the manufacturer-stated battery capacity) that a battery must have to pass a test of battery capacity. The target capacity is an arbitrary benchmark set by the user. The default setting is 80%, but it can be changed.

**TCP/IP**

Transmission Control Protocol/Interface Protocol. A protocol used for computer communications.

**Toggle**

A function that has two states (for example On and Off) that are selected alternately each time you click the same button or check box.

**Trickle Charge**

A maintenance charge used to compensate for battery self-discharge.

**UDP**

User datagram protocol, UDP uses ports to allow application-to-application communication on networked computers.

**UPS**

Uninterruptible Power Supply, a device that prevents a power blackout or brownout from causing a computer to lose data. When AC from the power utility fails, a UPS converts DC battery power to AC, providing AC power for a period of time sufficient for you to shut down the computer.

**USB**

Universal Serial Bus. A serial bus standard to interface devices.

**User Interface**

The LCD display, LEDs and input keys on the front panel of a battery tester, used to display status and control battery tests.

**Volt**

The SI unit of electromotive force, the difference of potential that would carry one ampere of current against one ohm of resistance.

**Volts**

Electric potential difference expressed in volts.