

15 W AC-DC Modules PA15A-Series

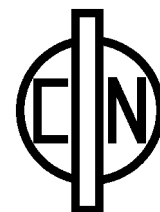

PHI-CON

- AC-DC Power module
- Universal input 85-265 VAC
- High efficiency up to 82 %
- Short circuit protection
- Internal input filter
- 3 years warranty



Model selection guide

Type	Output power [W]	Input voltage range [V _{AC}]	Output voltage [V _{DC}]	Output current [mA]	Efficiency typ. [%]
Single output					
PA15A03_01	13	85 – 265	+3.3	4000	73
PA15A05_01	15	85 – 265	+5	3000	76
PA15A12_01	15	85 – 265	+12	1250	82
PA15A15_01	15	85 – 265	+15	1000	82
PA15A24_01	15	85 – 265	+24	625	82
Dual output					
PA15A12D_01	15	85 – 265	±12	±625	81
PA15A15D_01	15	85 – 265	±15	±500	80
PA15A503D_01	15	85 – 265	+5 / +3.3	+1000 / +3000	74

15W AC-DC Modules PA15A-Series

Specifications

All specifications typical at nominal line, full load, 25 °C unless otherwise noticed.

Input	
Voltage range	85 – 265 VAC 120 – 375 VDC
Rated input voltage	85 – 265 VAC
Line frequency	47 – 63 Hz
Inrush current	max. 10 A @ 115 VAC max. 18 A @ 230 VAC
Input current	115/230 VAC, I _o nom 0.31 / 0.19 A
Rated input current	V _i : 85 VAC, I _o nom: 500 mA
Leakage current	Input – Output: 0.25 mA
Isolation	
Voltage	3000 / 4242 VAC/VDC
Resistance	100 MΩ @ 500 VDC
Output	
Voltage accuracy	± 2 % max
Minimum Load	single output models: 0% dual output models: 20% (each output)
Line voltage regulation	± 1%, max.
Load voltage regulation	single models: ± 2% max. dual models: ± 2% max.
Cross regulation	Asymmetrical load 20 % / 100 % FL: ±6 %
Hold up time	V _i : 115/230 VAC, I _o nom: 15 / 30 ms min
Turn on time	1000 ms
Rise time	150 ms
Fall time	150 ms
Transient recovery time	V _i nom, 1 ~0.5 I _o nom: 1 ms
Ripple & noise (V _i nom, I _o nom, BW = 20 MHz)	3,3 & 15 V models : 100 mV, 12, 15, 24 V & dual : 150 mV
External trim ADJ. Range (for single output only)	Min -10 %, max + 10 % (I _o = 5 % ... 100 %)
Temperature coefficient	± 0.03% / °C

General	
Efficiency	Up to 82 %, see model list and typ efficiency curve
Switching frequency	100 kHz, typ.
MTBF	Bellcore issue 6 @ 40 °C, GB 3,3V, 5V, & 503D models: 1220000 hours 12V, 15V & 24V models: 1250000 hours 12D & 15D models: 1230000 hours
Altitude during operation	IEC 60068-2-13 max 4850 m
Environmental	
Operating temperature (ambient)	-40 °C – +71 °C
Storage temperature	-40 °C – +100 °C
Case temperature	+85°C max.
Derating V _i nom, 51 to 71°	2% / °C
Humidity	20 - 95% RH
Cooling	Free-air convection
Physical	
Dimensions	76.2x50.8x22.8 mm
Weight	160 g
Case material	plastic
Potting material	Epoxy
Control and protection	
Input fuse	T2A / 250 VAC internal
Internal surge voltage protection	IEC 61000-4-5 Varistor
Output short circuit	Hiccup mode
Approvals and standards	
UL / cUL	UL60950-1, Recognized
TUV	EN60950-1, CB scheme
CE	EN 61000-6-3, EN 55022 Class B, EN 61000-3-2 EN 61000-3-3, EN 61000-6-2, EN 55024, EN61000-4-2, EN 61000-4-3, EN 61000-4-4, EN 61000-4-5, EN 61000-4-6, EN 61000-4-8, EN 61000-4-11, EN 61204-3
Vibration resistance	Meet IEC 60068-2-6 (10-500 Hz, 2G, along X, Y, Z each Axis, 60 min for each Axis)
Shock resistance	Meet IEC 60068-2-27 (15G 11 ms, 3 axes, 6 faces, 3 times for each face)

15 W AC-DC Modules PA15A-Series



Mechanism & Pin Configuration

mm [inch]

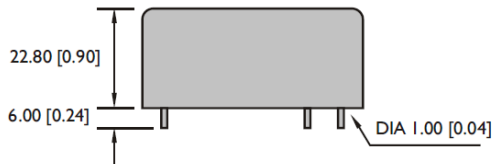

GENERAL TOLERANCE	
0.00[0.00] - 30.00[1.18]	±0.30[0.01]
30.00[1.18] - 120.00[4.72]	±0.50[0.02]

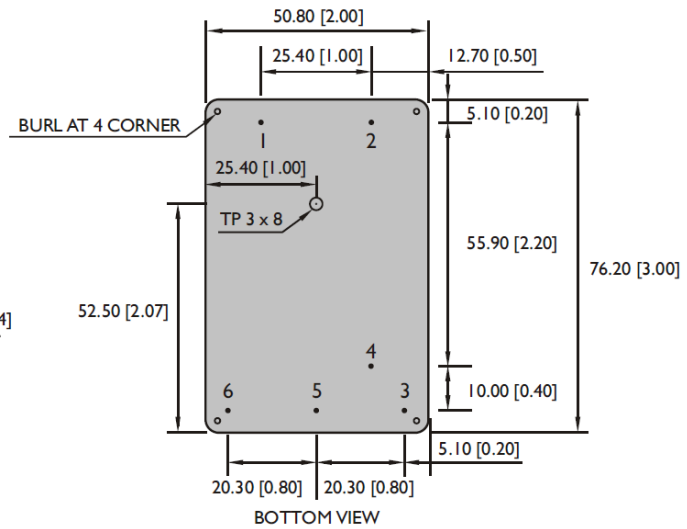

PIN Assignment

PIN No.	1	2	3	4	5	6
Single	AC IN	AC IN	Vo -	Trim	NO PIN	Vo +
Dual 12D 15D	AC IN	AC IN	Vo -	NO PIN	Com	Vo +
Dual 503D	AC IN	AC IN	+ 3.3V	NO PIN	Com	+ 5V

Circuit Schematic

Block diagram for single output

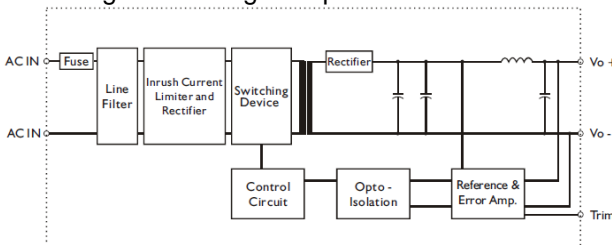

Block diagram for dual output

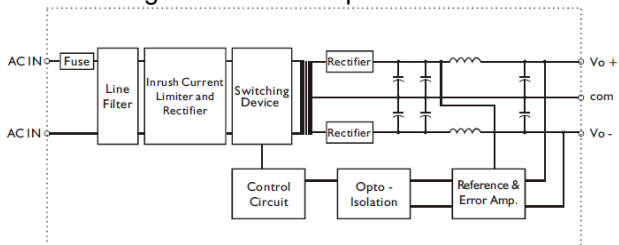

Circuit Schematic

Block diagram for PA15A503D_01

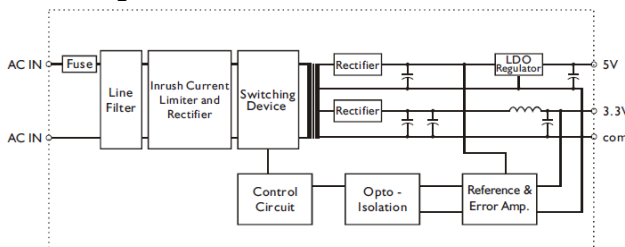

Typ. Current Limited Curve

PA15A24_01

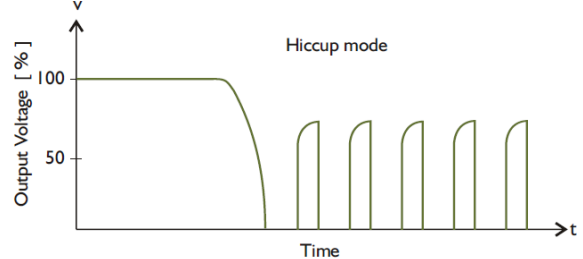

15 W AC-DC Modules PA15A-Series



Derating Curve

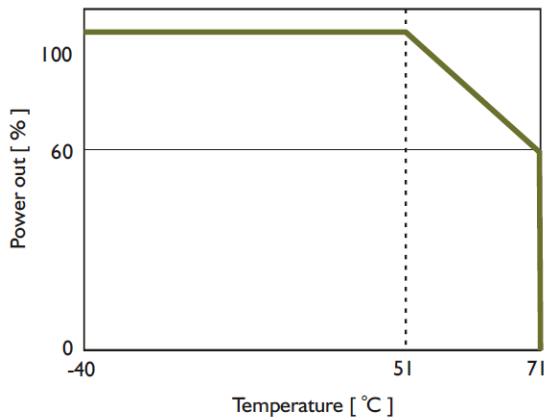

Typ. Efficiency Curve

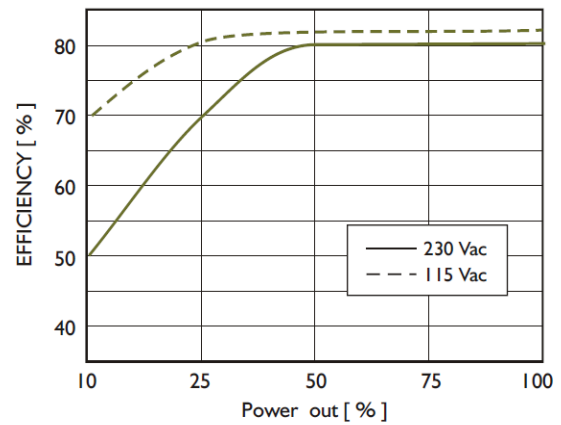

Fig. I Trim connection (for single output only)

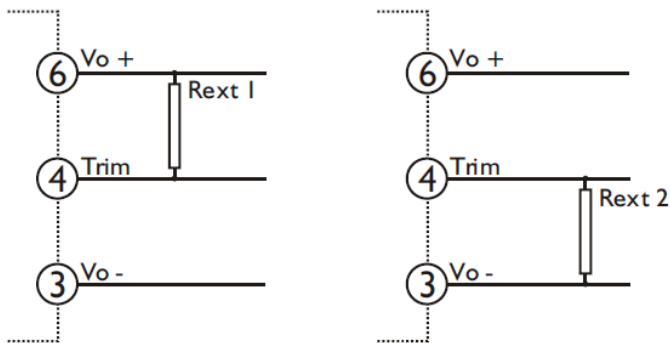

Table I Typical resistor values for various output voltage adjustment settings and max continuous power

Type	Rext 1 Vo nom -5 %	Rext 1 Vo nom - 10%	Rext 2 Vo nom +5%	Rext 2 Vo nom +10%	Maximal continuous power
PA15A03_01	180 kΩ	56 kΩ	100 kΩ	20 kΩ	13 W
PA15A05_01	39 kΩ	15 kΩ	9.1 kΩ	2.2 kΩ	15 W
PA15A12_01	51 kΩ	20 kΩ	10 kΩ	2 Ω	15 W
PA15A15_01	150 kΩ	68 kΩ	20 kΩ	4.7 kΩ	15 W
PA15A24_01	130 kΩ	56 kΩ	12 kΩ	2 Ω	15 W